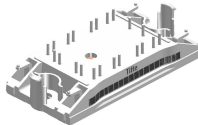
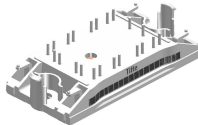
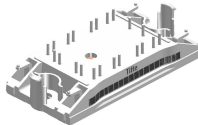
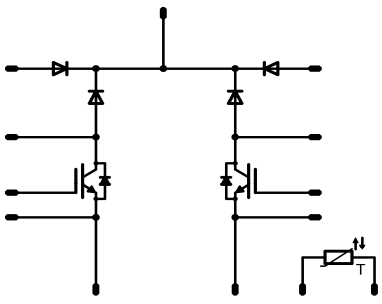
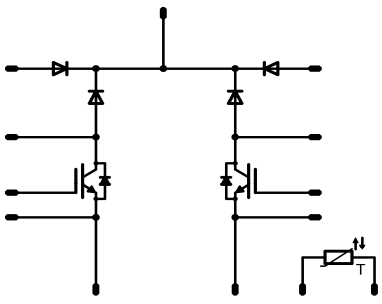
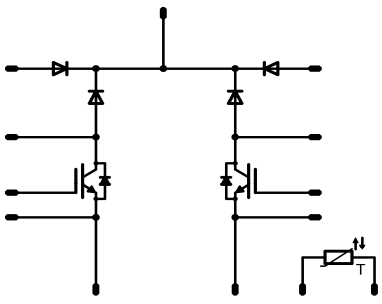

flowBOOST	1200V/40A				
<table border="1" style="width: 100%; border-collapse: collapse;"> <tr style="background-color: #000080; color: white;"> <th style="padding: 2px;">Features</th> </tr> <tr> <td style="padding: 2px;"> <ul style="list-style-type: none"> High efficiency dual boost Ultra fast switching frequency Low Inductance Layout 1200V IGBT and 1200V Si diode </td> </tr> </table>	Features	<ul style="list-style-type: none"> High efficiency dual boost Ultra fast switching frequency Low Inductance Layout 1200V IGBT and 1200V Si diode 	<table border="1" style="width: 100%; border-collapse: collapse;"> <tr style="background-color: #000080; color: white;"> <th style="padding: 2px;">flow0 17mm housing</th> </tr> <tr> <td style="text-align: center; padding: 5px;">  </td> </tr> </table>	flow0 17mm housing	
Features					
<ul style="list-style-type: none"> High efficiency dual boost Ultra fast switching frequency Low Inductance Layout 1200V IGBT and 1200V Si diode 					
flow0 17mm housing					
					
<table border="1" style="width: 100%; border-collapse: collapse;"> <tr style="background-color: #000080; color: white;"> <th style="padding: 2px;">Target Applications</th> </tr> <tr> <td style="padding: 2px;"> <ul style="list-style-type: none"> solar inverter </td> </tr> </table>	Target Applications	<ul style="list-style-type: none"> solar inverter 	<table border="1" style="width: 100%; border-collapse: collapse;"> <tr style="background-color: #000080; color: white;"> <th style="padding: 2px;">Schematic</th> </tr> <tr> <td style="text-align: center; padding: 5px;">  </td> </tr> </table>	Schematic	
Target Applications					
<ul style="list-style-type: none"> solar inverter 					
Schematic					
					
<table border="1" style="width: 100%; border-collapse: collapse;"> <tr style="background-color: #000080; color: white;"> <th style="padding: 2px;">Types</th> </tr> <tr> <td style="padding: 2px;"> <ul style="list-style-type: none"> V23990-P629-L59-PM </td> </tr> </table>	Types	<ul style="list-style-type: none"> V23990-P629-L59-PM 			
Types					
<ul style="list-style-type: none"> V23990-P629-L59-PM 					

Maximum Ratings

T_j=25°C, unless otherwise specified

Parameter	Symbol	Condition	Value	Unit
Bypass Diode (D7 , D8)				
Repetitive peak reverse voltage	V _{RRM}	T _j =25°C	1600	V
DC forward current	I _{FAV}	T _j =T _{jmax} T _h =80°C T _c =80°C	34 40	A
Surge forward current	I _{FSM}	t _p =10ms sin 180° T _j =25°C	220	A
I ² t-value	I ² t		240	A ² s
Power dissipation per Diode	P _{tot}	T _j =T _{jmax} T _h =80°C T _c =80°C	42 63	W
Maximum Junction Temperature	T _{jmax}		150	°C
Boost IGBT (T1 , T2)				
Collector-emitter break down voltage	V _{CE}	T _j =25°C	1200	V
DC collector current	I _C	T _j =T _{jmax} T _h =80°C T _c =80°C	40 45	A
Pulsed collector current	I _{Cpulse}	t _p limited by T _{jmax}	120	A
Power dissipation per IGBT	P _{tot}	T _j =T _{jmax} T _h =80°C T _c =80°C	113 171	W
Gate-emitter peak voltage	V _{GE}		±20	V
Short circuit ratings	t _{SC} V _{CC}	T _j ≤150°C V _{GE} =15V	10 800	µs V
Maximum Junction Temperature	T _{jmax}		175	°C

Maximum Ratings

 $T_j=25^{\circ}\text{C}$, unless otherwise specified

Parameter	Symbol	Condition	Value	Unit
-----------	--------	-----------	-------	------

Boost IGBT Protection Diode (D9 , D10)

Peak Repetitive Reverse Voltage	V_{RRM}	$T_j=25^{\circ}\text{C}$	1200	V	
DC forward current	I_F	$T_j=T_{jmax}$	$T_h=80^{\circ}\text{C}$	10	A
			$T_c=80^{\circ}\text{C}$	13	
Surge forward current	I_{FSM}	$t_p=10\text{ms}$, $\sin 180^{\circ}$, $T_j=T_{jmax}$	21	A	
Power dissipation per Diode	P_{tot}	$T_j=T_{jmax}$	$T_h=80^{\circ}\text{C}$	26	W
			$T_c=80^{\circ}\text{C}$	39	
Maximum Junction Temperature	T_{jmax}		150	$^{\circ}\text{C}$	

Boost FWD (D1 , D4)

Peak Repetitive Reverse Voltage	V_{RRM}	$T_j=25^{\circ}\text{C}$	1200	V	
DC forward current	I_F	$T_j=T_{jmax}$	$T_h=80^{\circ}\text{C}$	39	A
			$T_c=80^{\circ}\text{C}$	53	
Surge forward current	I_{FSM}	$t_p=10\text{ms}$, $\sin 180^{\circ}$, $T_j=25^{\circ}\text{C}$	270	A	
Power dissipation	P_{tot}	$T_j=T_{jmax}$	$T_h=80^{\circ}\text{C}$	89	W
			$T_c=80^{\circ}\text{C}$	134	
Maximum Junction Temperature	T_{jmax}		175	$^{\circ}\text{C}$	

Thermal Properties

Storage temperature	T_{slg}		-40...+125	$^{\circ}\text{C}$
Operation temperature under switching condition	T_{op}		-40...+($T_{jmax} - 25$)	$^{\circ}\text{C}$

Insulation Properties

Insulation voltage	V_{is}	$t=2\text{s}$ DC voltage	4000	V
Creepage distance			min 12,7	mm
Clearance			min 12,7	mm

Characteristic Values

Parameter	Symbol	Conditions					Value			Unit
		$V_{GE}[V]$ or $V_{GS}[V]$	$V_r[V]$ or $V_{CE}[V]$ or $V_{DS}[V]$	$I_c[A]$ or $I_F[A]$ or $I_b[A]$	T_j	Min	Typ	Max		
Bypass Diode (D7 , D8)										
Forward voltage	V_F			25	$T_j=25^\circ\text{C}$ $T_j=125^\circ\text{C}$	0,7	1,15 1,11	1,4		V
Threshold voltage (for power loss calc. only)	V_{to}			24	$T_j=25^\circ\text{C}$ $T_j=125^\circ\text{C}$		0,92 0,82			V
Slope resistance (for power loss calc. only)	r_t			24	$T_j=25^\circ\text{C}$ $T_j=125^\circ\text{C}$		0,009 0,012			Ω
Reverse current	I_r		1600		$T_j=25^\circ\text{C}$ $T_j=125^\circ\text{C}$			0,05		mA
Thermal resistance chip to heatsink per chip	R_{thJH}	Thermal grease thickness \leq 50um $\lambda = 1 \text{ W/mK}$					1,67			K/W
Thermal resistance chip to case per chip	R_{thJC}						1,10			K/W
Boost IGBT (T1 , T2)										
Gate emitter threshold voltage	$V_{GE(th)}$		$V_{GE}=V_{CE}$	0,0015	$T_j=25^\circ\text{C}$ $T_j=125^\circ\text{C}$	5,2	5,8	6,4		V
Collector-emitter saturation voltage	$V_{CE(sat)}$		15	40	$T_j=25^\circ\text{C}$ $T_j=125^\circ\text{C}$	1,7	2,10 2,48	2,6		V
Collector-emitter cut-off	I_{CES}		0	1200	$T_j=25^\circ\text{C}$ $T_j=125^\circ\text{C}$			0,25		mA
Gate-emitter leakage current	I_{GES}		20	0	$T_j=25^\circ\text{C}$ $T_j=125^\circ\text{C}$			200		nA
Integrated Gate resistor	R_{gint}						none			Ω
Turn-on delay time	$t_{d(on)}$	$R_{goff}=4 \Omega$ $R_{gon}=4 \Omega$	15	700	24	$T_j=25^\circ\text{C}$	22		ns	
Rise time	t_r					$T_j=125^\circ\text{C}$	21			
Turn-off delay time	$t_{d(off)}$					$T_j=25^\circ\text{C}$	35			
Fall time	t_f					$T_j=125^\circ\text{C}$	68			
Turn-on energy loss per pulse	E_{on}					$T_j=25^\circ\text{C}$	225			
Turn-off energy loss per pulse	E_{off}	$T_j=125^\circ\text{C}$	293							
Input capacitance	C_{ies}	$f=1\text{MHz}$	0	25	$T_j=25^\circ\text{C}$		2300		pF	
Output capacitance	C_{oss}						150			
Reverse transfer capacitance	C_{riss}						135			
Gate charge	Q_{Gate}		15	600	40	$T_j=25^\circ\text{C}$	185		nC	
Thermal resistance chip to heatsink per chip	R_{thJH}	Thermal grease thickness \leq 50um $\lambda = 1 \text{ W/mK}$					0,84		K/W	
Thermal resistance chip to case per chip	R_{thJC}						0,56		K/W	
Boost IGBT Protection Diode (D9 , D10)										
Diode forward voltage	V_F			3	$T_j=25^\circ\text{C}$ $T_j=125^\circ\text{C}$	0,7	1,66 1,58	2,4		V
Thermal resistance chip to heatsink per chip	R_{thJH}	Thermal grease thickness \leq 50um $\lambda = 1 \text{ W/mK}$					2,72		K/W	
Thermal resistance chip to case per chip	R_{thJC}						1,80		K/W	
Boost FWD (D1 , D4)										
Forward voltage	V_F			50	$T_j=25^\circ\text{C}$ $T_j=125^\circ\text{C}$	1,5	2,28 2,36	2,8		V
Reverse leakage current	I_{rm}			1200	$T_j=25^\circ\text{C}$ $T_j=125^\circ\text{C}$			60		μA
Peak recovery current	I_{RRM}	$R_{gon}=4 \Omega$	15	700	24	$T_j=25^\circ\text{C}$	63		A	
Reverse recovery time	t_{rr}					$T_j=125^\circ\text{C}$	78			
Reverse recovery charge	Q_{rr}					$T_j=25^\circ\text{C}$	83			
Reverse recovered energy	E_{rec}					$T_j=125^\circ\text{C}$	208			
Peak rate of fall of recovery current	$di(rec)_{max}/dt$					$T_j=25^\circ\text{C}$	2,25			
Thermal resistance chip to heatsink per chip	R_{thJH}	Thermal grease thickness \leq 50um $\lambda = 1 \text{ W/mK}$					1,07		K/W	
Thermal resistance chip to case per chip	R_{thJC}						0,71		K/W	

Characteristic Values

Parameter	Symbol	Conditions					Value			Unit
		$V_{GE}[V]$ or $V_{GS}[V]$	$V_r[V]$ or $V_{CE}[V]$ or $V_{DS}[V]$	$I_c[A]$ or $I_F[A]$ or $I_D[A]$	T_j	Min	Typ	Max		
Thermistor										
Rated resistance	R					$T_j=25^{\circ}C$		21511		Ω
Deviation of R25	$\Delta R/R$	R100=1486 Ω				$T_c=100^{\circ}C$	-4,5		+4,5	%
Power dissipation	P					$T_j=25^{\circ}C$		210		mW
Power dissipation constant						$T_j=25^{\circ}C$		3,5		mW/K
B-value	B(25/50)					$T_j=25^{\circ}C$		3884		K
B-value	B(25/100)	Tol. $\pm 1\%$				$T_j=25^{\circ}C$		3964		K
Vincotech NTC Reference									F	

Boost IGBT Protection Diode

Figure 1 Boost IGBT Protection Diode

Typical FWD forward current as a function of forward voltage

$$I_F = f(V_F)$$

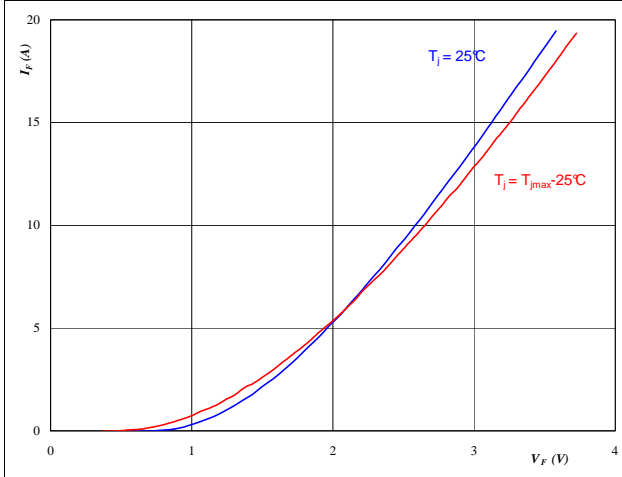
At
 $t_p = 250 \mu s$
Figure 2 Boost IGBT Protection Diode

Diode transient thermal impedance as a function of pulse width

$$Z_{thJC} = f(t_p)$$

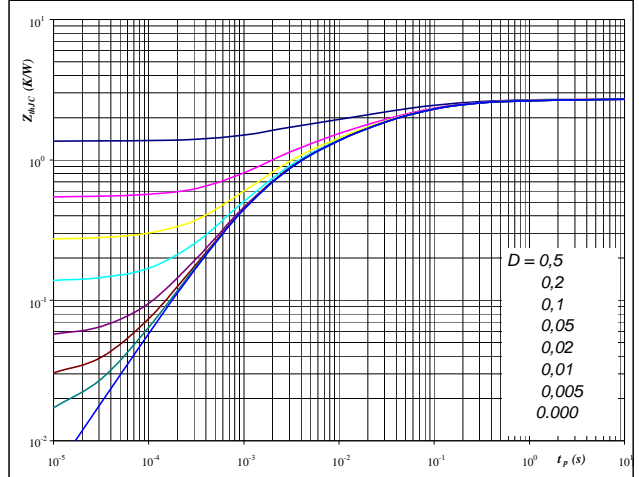
At
 $D = t_p / T$
 $R_{thJH} = 2,72 \text{ K/W}$
Figure 3 Boost IGBT Protection Diode

Power dissipation as a function of heatsink temperature

$$P_{tot} = f(T_h)$$

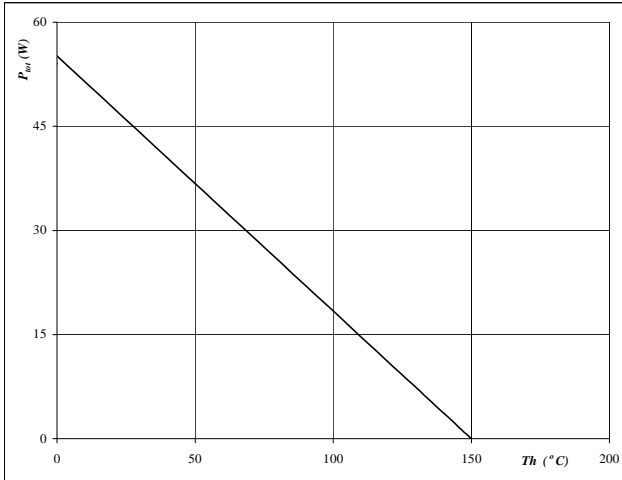
At
 $T_j = 150 \text{ }^\circ\text{C}$
Figure 4 Boost IGBT Protection Diode

Forward current as a function of heatsink temperature

$$I_F = f(T_h)$$

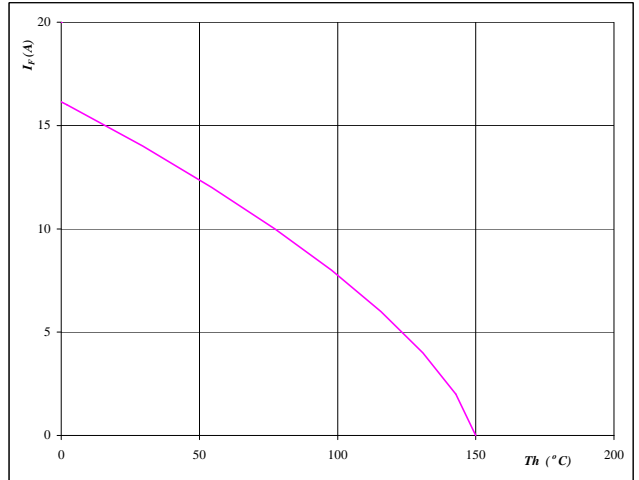
At
 $T_j = 150 \text{ }^\circ\text{C}$

INPUT BOOST

Figure 3 BOOST IGBT
Typical output characteristics

$I_C = f(V_{CE})$

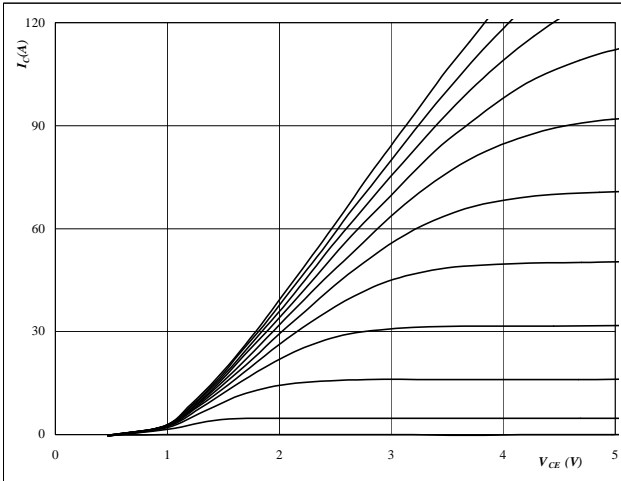

At
 $t_p = 250 \mu s$
 $T_j = 25 \text{ }^\circ C$
 V_{GS} from 7 V to 17 V in steps of 1 V

Figure 4 BOOST FWD
Typical output characteristics

$I_C = f(V_{CE})$

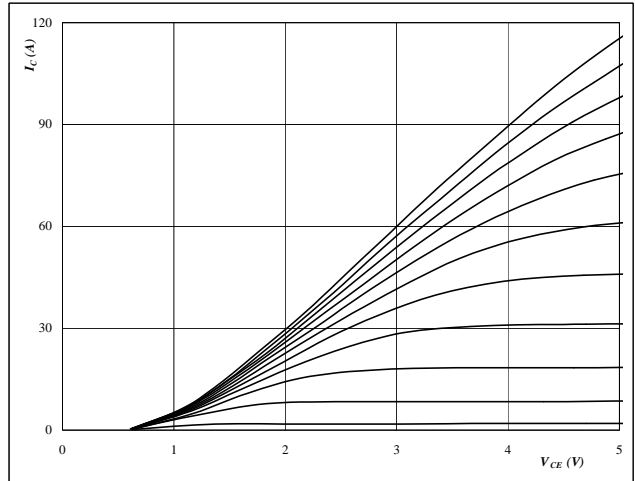

At
 $t_p = 250 \mu s$
 $T_j = 125 \text{ }^\circ C$
 V_{GS} from 7 V to 17 V in steps of 1 V

Figure 3 BOOST IGBT
Typical transfer characteristics

$I_C = f(V_{GE})$

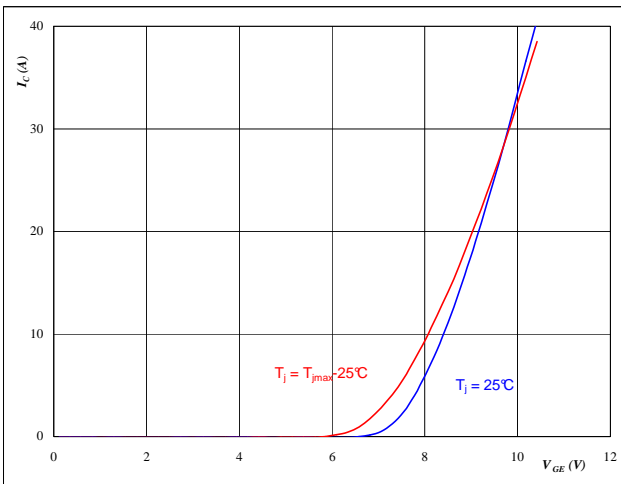

At
 $t_p = 250 \mu s$
 $V_{DS} = 10 V$

Figure 4 BOOST FWD
Typical FWD forward current as a function of forward voltage

$I_F = f(V_F)$

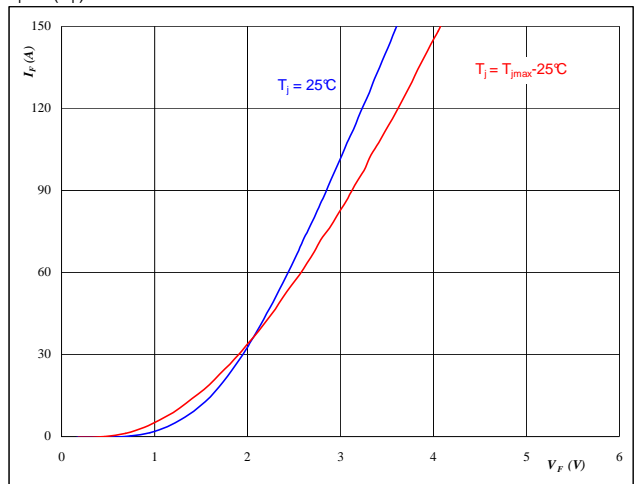

At
 $t_p = 250 \mu s$

INPUT BOOST

Figure 5 BOOST IGBT

**Typical switching energy losses
as a function of collector current**

$$E = f(I_C)$$

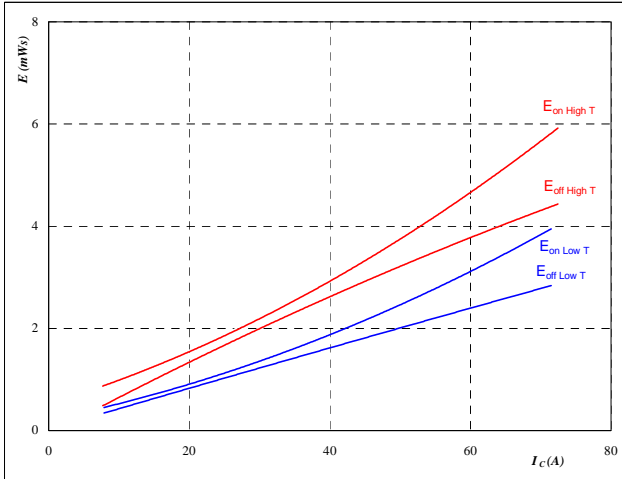

With an inductive load at

$T_J =$	25/125	°C
$V_{DS} =$	700	V
$V_{GS} =$	15	V
$R_{gon} =$	4	Ω
$R_{goff} =$	4	Ω

Figure 6 BOOST IGBT

**Typical switching energy losses
as a function of gate resistor**

$$E = f(R_G)$$

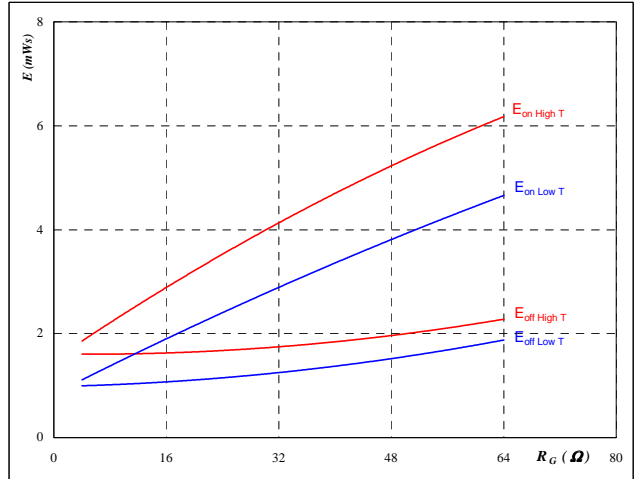

With an inductive load at

$T_J =$	25/125	°C
$V_{DS} =$	700	V
$V_{GS} =$	15	V
$I_D =$	24	A

Figure 7 BOOST IGBT

**Typical reverse recovery energy loss
as a function of collector (drain) current**

$$E_{rec} = f(I_C)$$

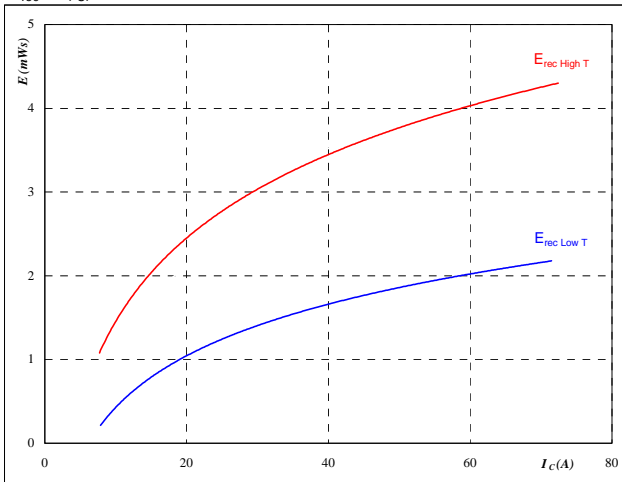

With an inductive load at

$T_J =$	25/125	°C
$V_{DS} =$	700	V
$V_{GS} =$	15	V
$R_{gon} =$	4	Ω

Figure 8 BOOST IGBT

**Typical reverse recovery energy loss
as a function of gate resistor**

$$E_{rec} = f(R_G)$$

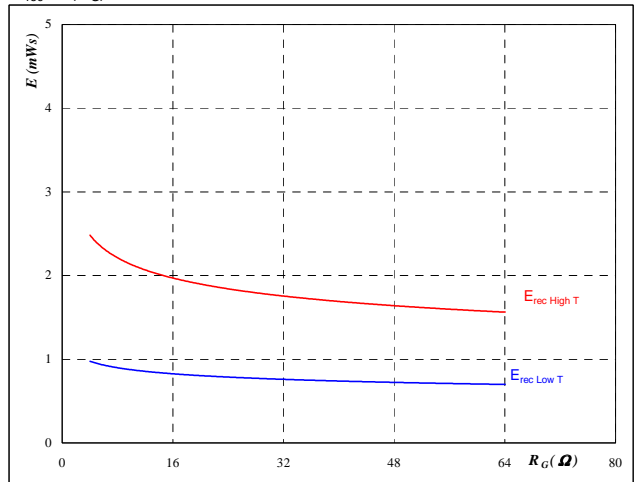

With an inductive load at

$T_J =$	25/125	°C
$V_{DS} =$	700	V
$V_{GS} =$	15	V
$I_D =$	24	A

INPUT BOOST

Figure 9 BOOST IGBT

Typical switching times as a function of collector current

$$t = f(I_C)$$

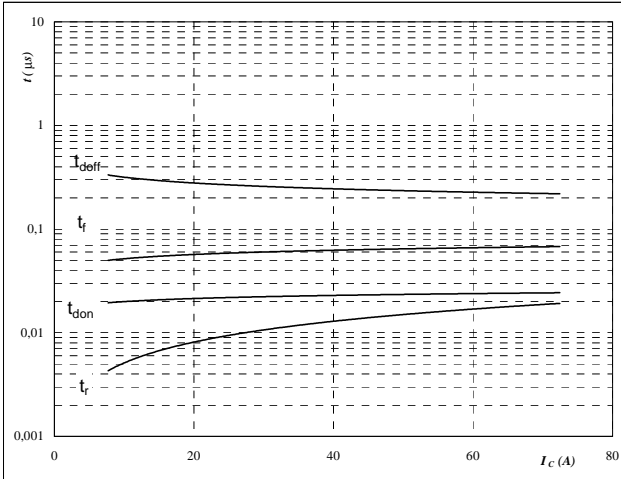

With an inductive load at

$T_J =$	125	°C
$V_{DS} =$	700	V
$V_{GS} =$	15	V
$R_{gon} =$	4	Ω
$R_{goff} =$	4	Ω

Figure 10 BOOST IGBT

Typical switching times as a function of gate resistor

$$t = f(R_G)$$

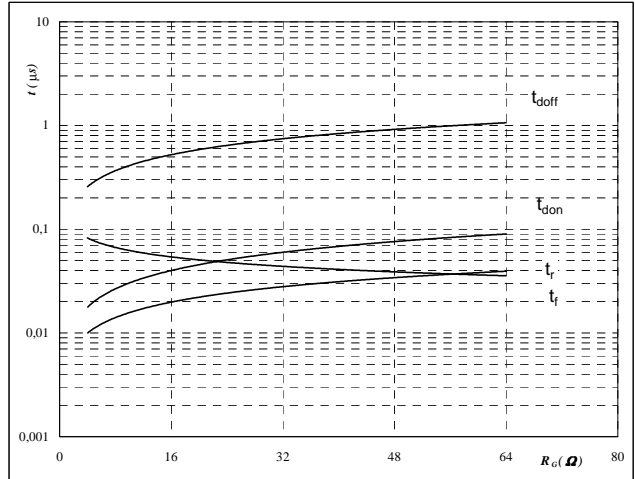

With an inductive load at

$T_J =$	125	°C
$V_{DS} =$	700	V
$V_{GS} =$	15	V
$I_C =$	24	A

Figure 11 BOOST FWD

Typical reverse recovery time as a function of collector current

$$t_{rr} = f(I_C)$$

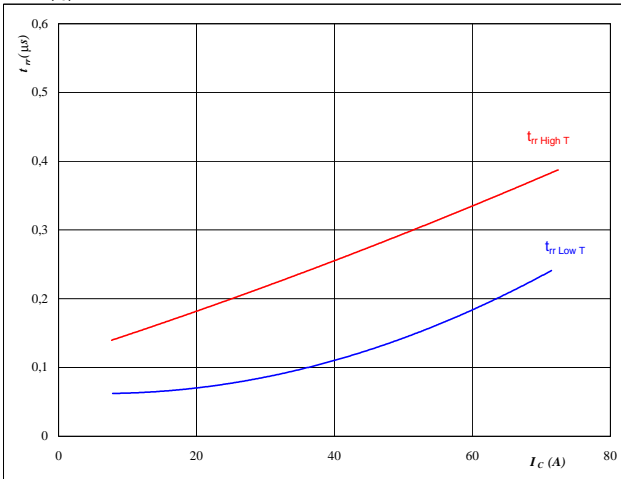

At

$T_J =$	25/125	°C
$V_{CE} =$	700	V
$V_{GE} =$	15	V
$R_{gon} =$	4	Ω

Figure 12 BOOST FWD

Typical reverse recovery time as a function of IGBT turn on gate resistor

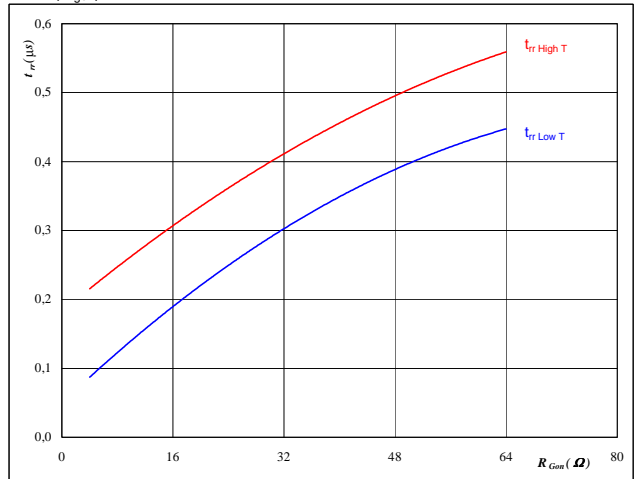
$$t_{rr} = f(R_{gon})$$



At

$T_J =$	25/125	°C
$V_R =$	700	V
$I_F =$	24	A
$V_{GS} =$	15	V

INPUT BOOST

Figure 13 BOOST FWD
Typical reverse recovery charge as a function of collector current

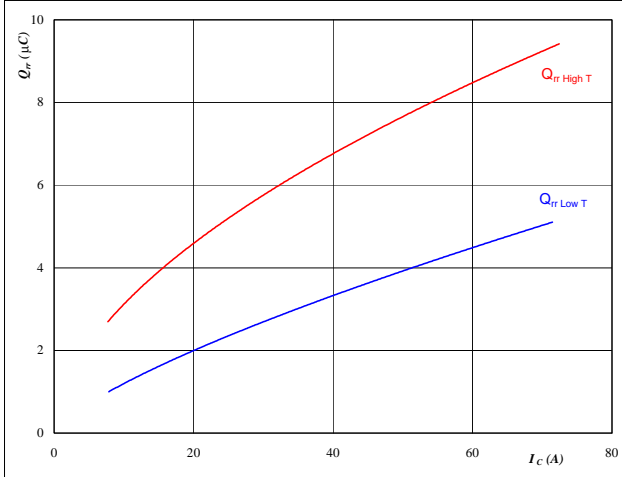
$$Q_{rr} = f(I_c)$$



At
 $T_j = 25/125$ °C
 $V_{CE} = 700$ V
 $V_{GE} = 15$ V
 $R_{gon} = 4$ Ω

Figure 14 BOOST FWD
Typical reverse recovery charge as a function of IGBT turn on gate resistor

$$Q_{rr} = f(R_{gon})$$

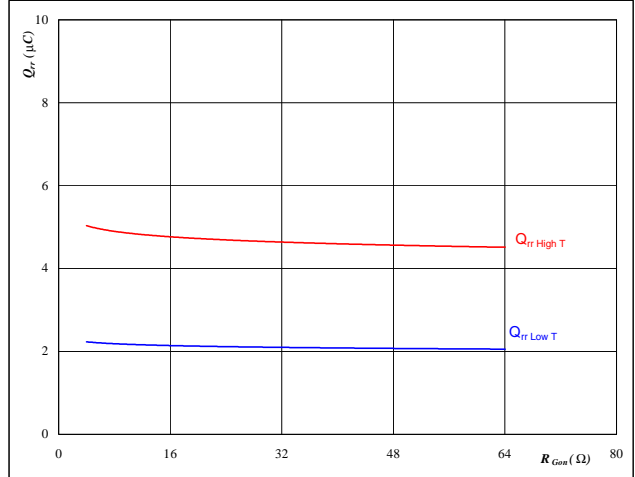

At
 $T_j = 25/125$ °C
 $V_R = 700$ V
 $I_F = 24$ A
 $V_{GS} = 15$ V

Figure 15 BOOST FWD
Typical reverse recovery current as a function of collector current

$$I_{RRM} = f(I_c)$$

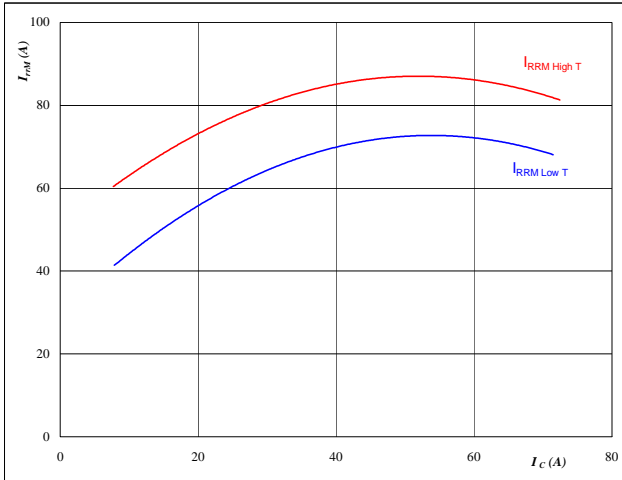

At
 $T_j = 25/125$ °C
 $V_{CE} = 700$ V
 $V_{GE} = 15$ V
 $R_{gon} = 4$ Ω

Figure 16 BOOST FWD
Typical reverse recovery current as a function of IGBT turn on gate resistor

$$I_{RRM} = f(R_{gon})$$

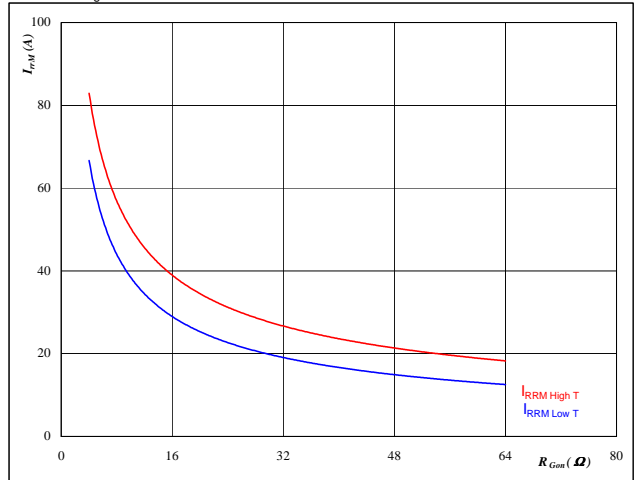

At
 $T_j = 25/125$ °C
 $V_R = 700$ V
 $I_F = 24$ A
 $V_{GS} = 15$ V

INPUT BOOST

Figure 17 BOOST FWD

Typical rate of fall of forward and reverse recovery current as a function of collector current

$$dI_{Q}/dt, dI_{rec}/dt = f(I_C)$$

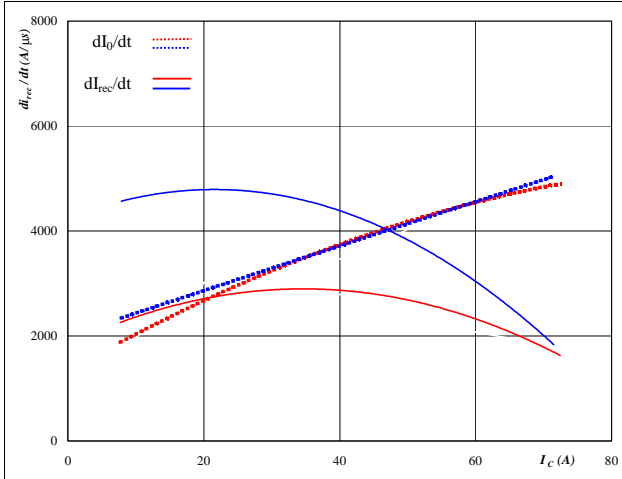

At
 $T_j = 25/125 \text{ } ^\circ\text{C}$
 $V_{CE} = 700 \text{ V}$
 $V_{GE} = 15 \text{ V}$
 $R_{gon} = 4 \text{ } \Omega$

Figure 18 BOOST FWD

Typical rate of fall of forward and reverse recovery current as a function of IGBT turn on gate resistor

$$dI_{Q}/dt, dI_{rec}/dt = f(R_{gon})$$

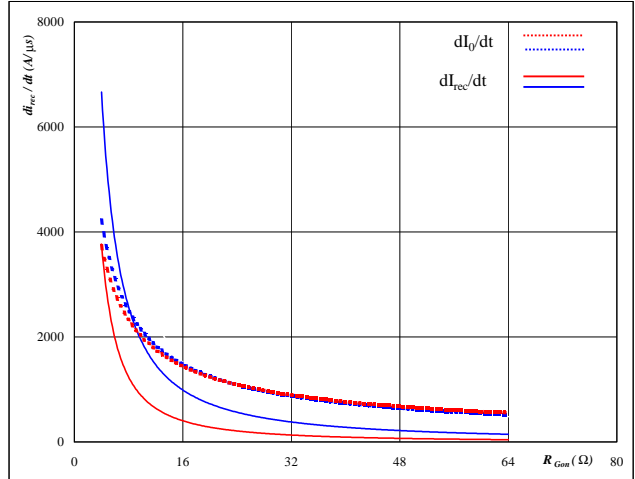

At
 $T_j = 25/125 \text{ } ^\circ\text{C}$
 $V_R = 700 \text{ V}$
 $I_F = 24 \text{ A}$
 $V_{GS} = 15 \text{ V}$

Figure 19 BOOST IGBT

IGBT/MOSFET transient thermal impedance as a function of pulse width

$$Z_{thJH} = f(t_p)$$

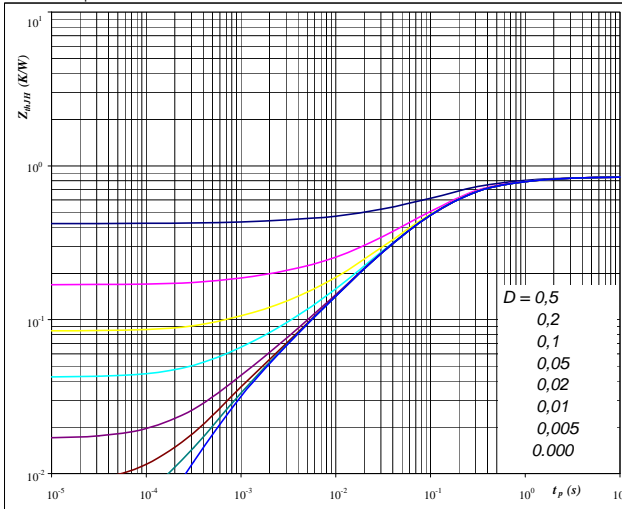

At
 $D = t_p / T$
 $R_{thJH} = 0,84 \text{ K/W}$

IGBT thermal model values

R (C/W)	Tau (s)
0,107	1,413
0,391	0,188
0,223	0,056
0,092	0,011
0,030	0,001

Figure 20 BOOST FWD

FWD transient thermal impedance as a function of pulse width

$$Z_{thJH} = f(t_p)$$

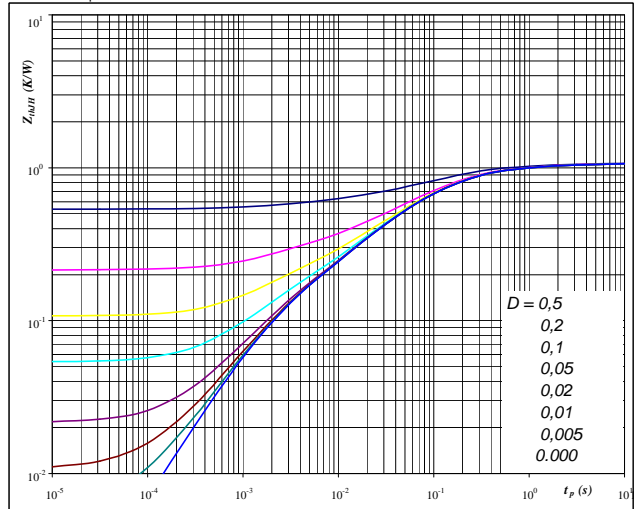

At
 $D = t_p / T$
 $R_{thJH} = 1,07 \text{ K/W}$

FWD thermal model values

R (C/W)	Tau (s)
0,027	8,145
0,098	1,332
0,284	0,228
0,405	0,069
0,171	0,014

INPUT BOOST

Figure 21 BOOST IGBT
Power dissipation as a function of heatsink temperature

$$P_{tot} = f(T_h)$$

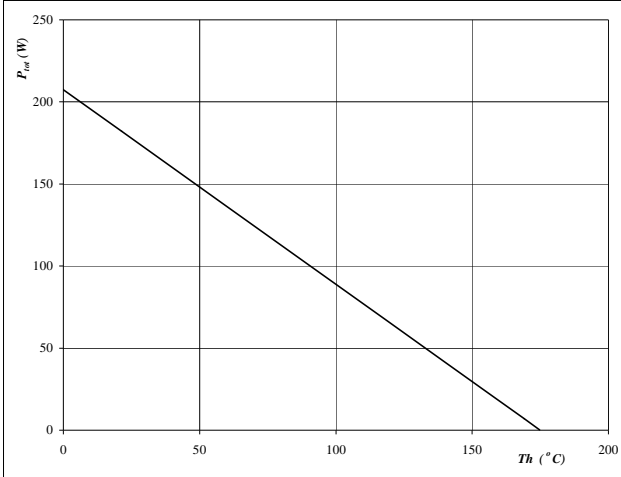
At
 $T_j = 175 \text{ } ^\circ\text{C}$
Figure 22 BOOST IGBT
Collector/Drain current as a function of heatsink temperature

$$I_C = f(T_h)$$

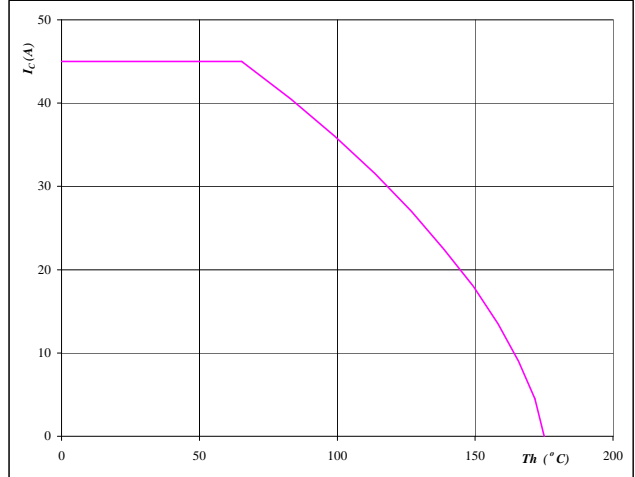
At
 $T_j = 175 \text{ } ^\circ\text{C}$
 $V_{GS} = 15 \text{ V}$
Figure 23 BOOST FWD
Power dissipation as a function of heatsink temperature

$$P_{tot} = f(T_h)$$

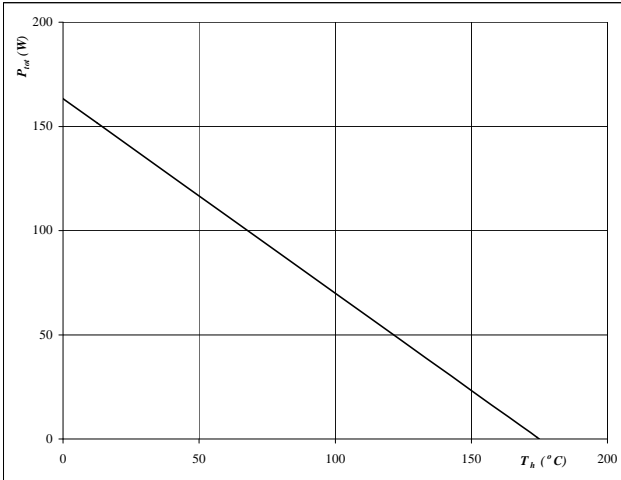
At
 $T_j = 175 \text{ } ^\circ\text{C}$
Figure 24 BOOST FWD
Forward current as a function of heatsink temperature

$$I_F = f(T_h)$$

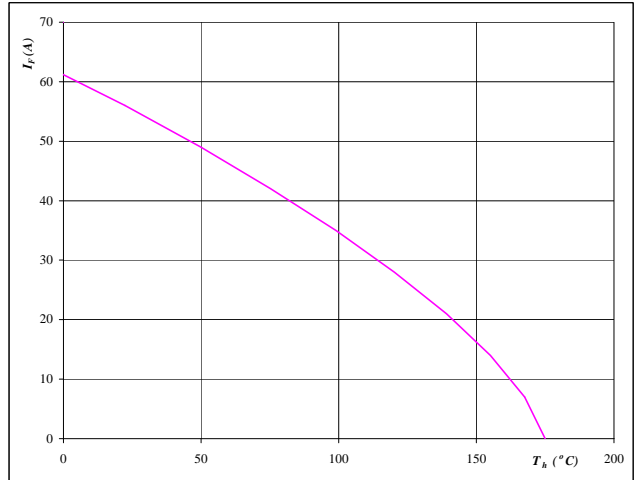
At
 $T_j = 175 \text{ } ^\circ\text{C}$

INPUT BOOST

Figure 25 BOOST IGBT
Safe operating area as a function of drain-source voltage

$$I_C = f(V_{CE})$$

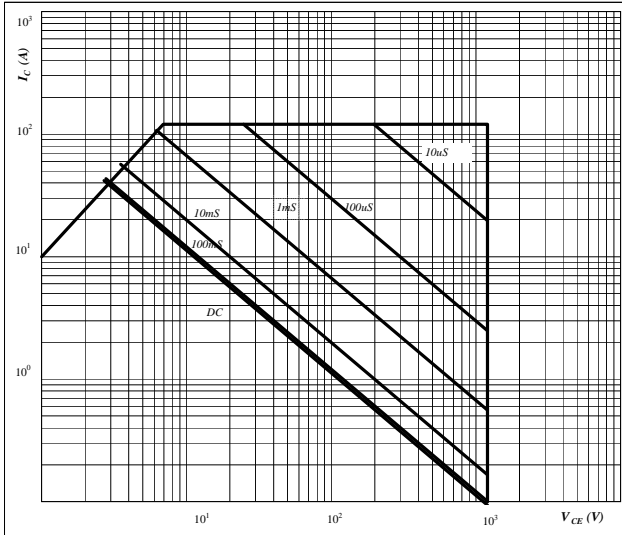

At
 D = single pulse
 $T_h = 80 \text{ } ^\circ\text{C}$
 $V_{GS} = 15 \text{ V}$
 $T_j = T_{jmax} \text{ } ^\circ\text{C}$

Figure 26 BOOST IGBT
Gate voltage vs Gate charge

$$V_{GE} = f(Q_g)$$

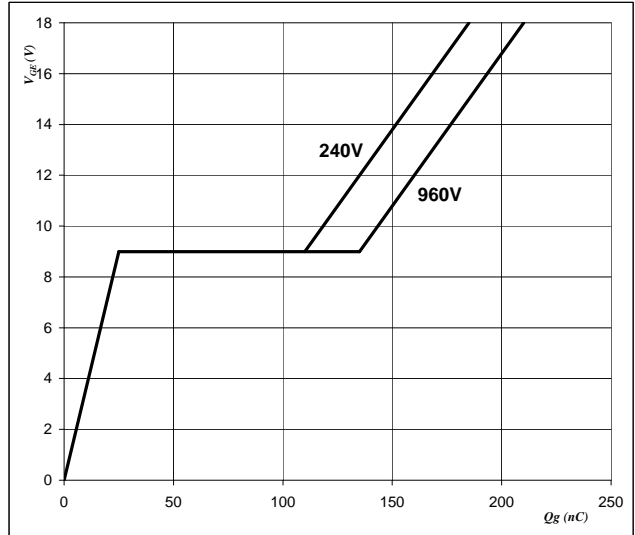

At
 $I_D = 24 \text{ A}$

Bypass Diode

Figure 1 Bypass Diode

Typical Diode forward current as a function of forward voltage

$$I_F = f(V_F)$$

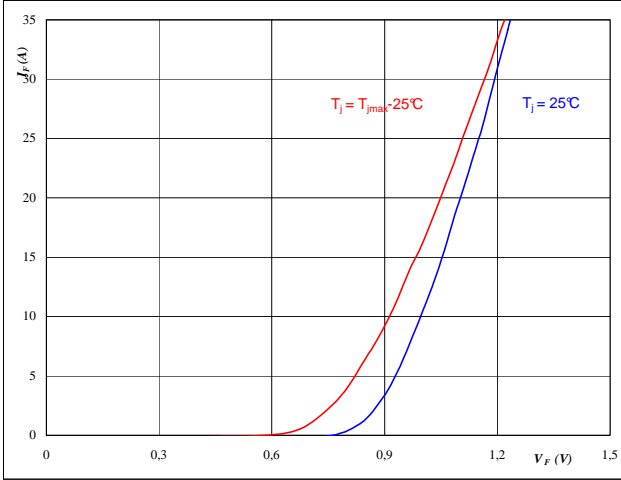
At
 $t_p = 250 \mu s$
Figure 2 Bypass Diode

Diode transient thermal impedance as a function of pulse width

$$Z_{thJH} = f(t_p)$$

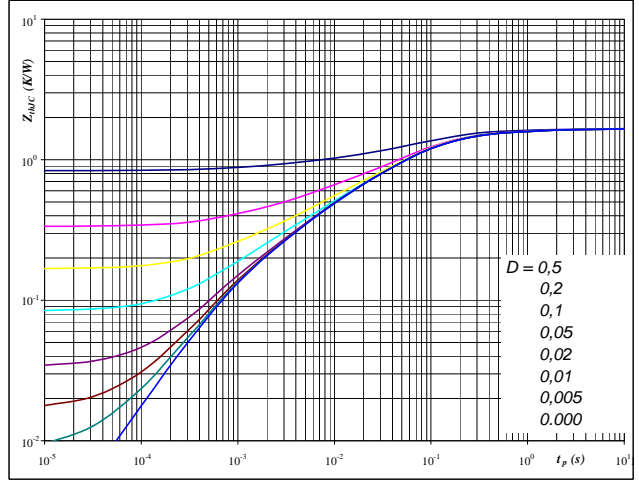
At
 $D = t_p / T$
 $R_{thJH} = 1,674 \text{ K/W}$
Figure 3 Bypass Diode

Power dissipation as a function of heatsink temperature

$$P_{tot} = f(T_h)$$

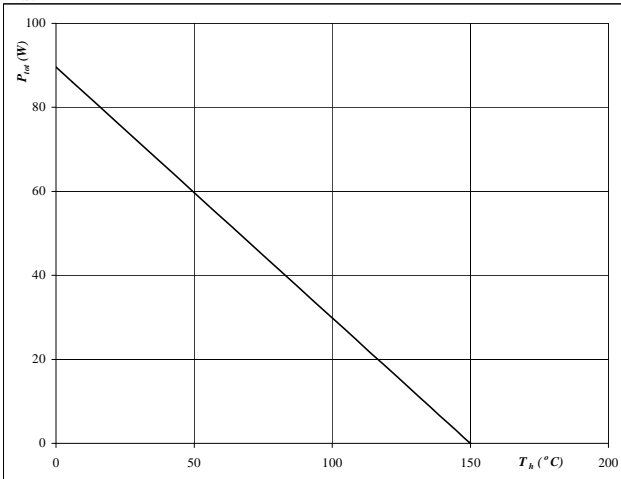
At
 $T_j = 150 \text{ °C}$
Figure 4 Bypass Diode

Forward current as a function of heatsink temperature

$$I_F = f(T_h)$$

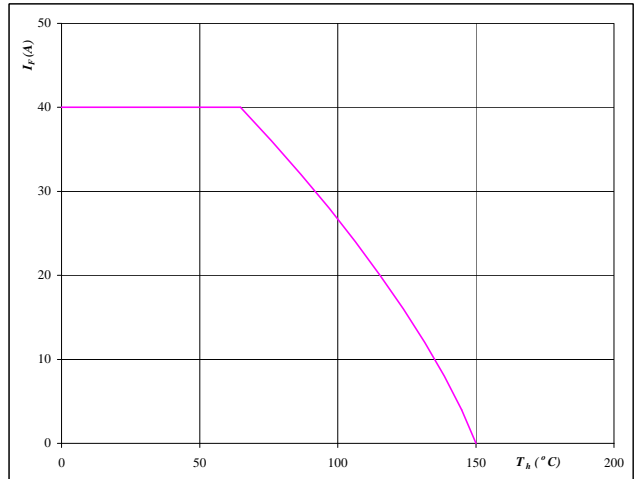

At
 $T_j = 150 \text{ °C}$

Thermistor

Figure 1 Thermistor

Typical NTC characteristic
as a function of temperature

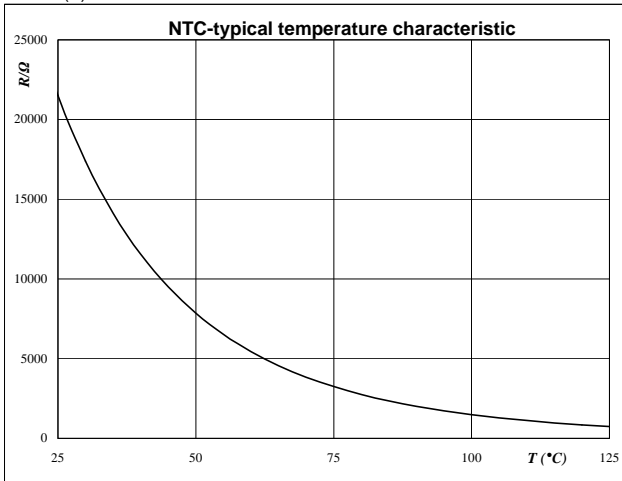
$$R_T = f(T)$$



Switching Definitions BOOST IGBT

General conditions	
T_j	= 125 °C
R_{gon}	= 4 Ω
R_{goff}	= 4 Ω

Figure 1 Boost IGBT

Turn-off Switching Waveforms & definition of t_{doff} , t_{Eoff}
 (t_{Eoff} = integrating time for E_{off})

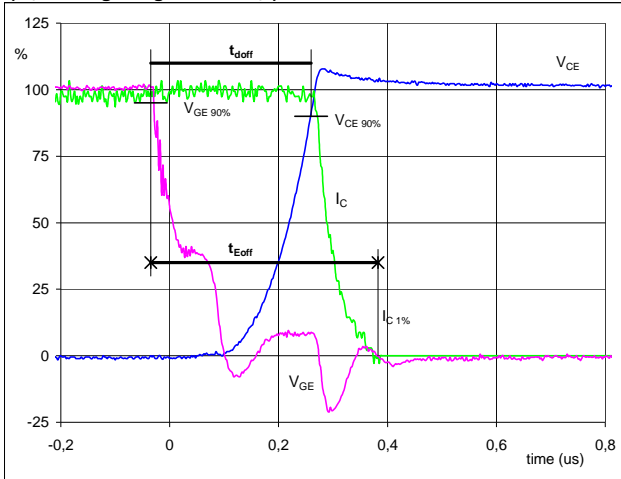

$V_{GE}(0\%) =$	0	V
$V_{GE}(100\%) =$	15	V
$V_C(100\%) =$	700	V
$I_C(100\%) =$	24	A
$t_{doff} =$	0,29	μs
$t_{Eoff} =$	0,42	μs

Figure 2 Boost IGBT

Turn-on Switching Waveforms & definition of t_{don} , t_{Eon}
 (t_{Eon} = integrating time for E_{on})

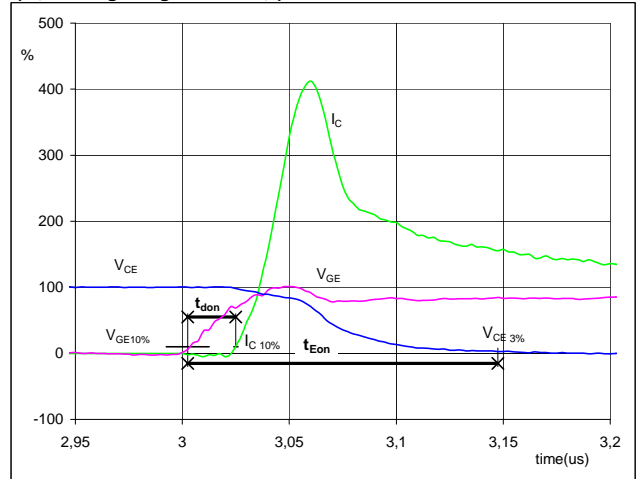

$V_{GE}(0\%) =$	0	V
$V_{GE}(100\%) =$	15	V
$V_C(100\%) =$	700	V
$I_C(100\%) =$	24	A
$t_{don} =$	0,02	μs
$t_{Eon} =$	0,14	μs

Figure 3 Boost IGBT

Turn-off Switching Waveforms & definition of t_f

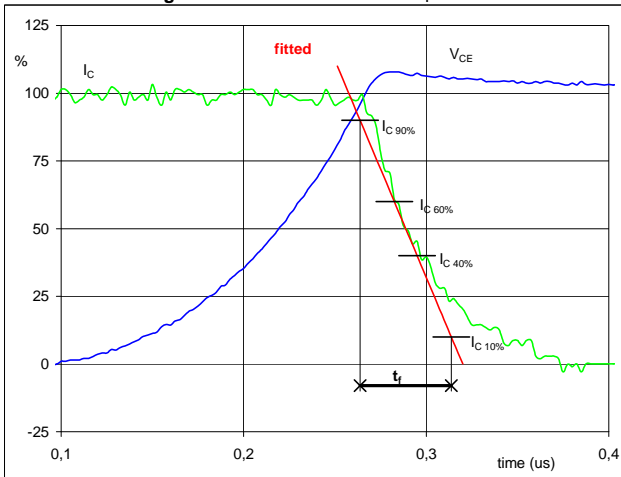

$V_C(100\%) =$	700	V
$I_C(100\%) =$	24	A
$t_f =$	0,06	μs

Figure 4 Boost IGBT

Turn-on Switching Waveforms & definition of t_r

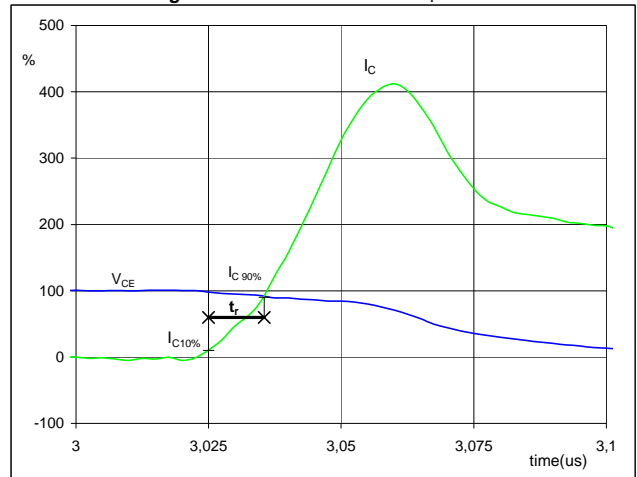

$V_C(100\%) =$	700	V
$I_C(100\%) =$	24	A
$t_r =$	0,01	μs

Switching Definitions BOOST IGBT

Figure 5 Boost IGBT

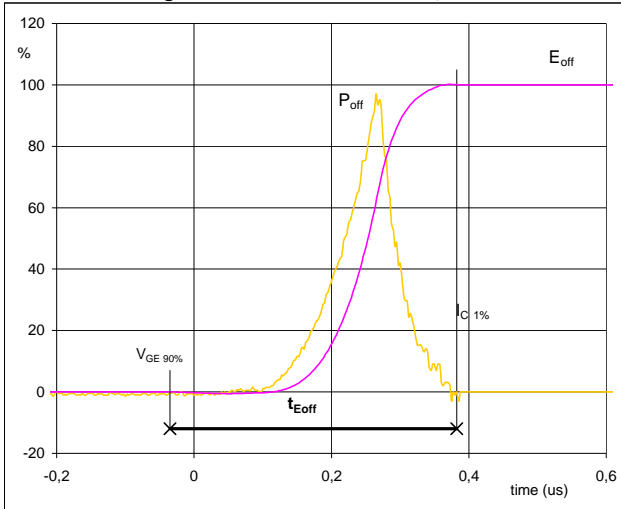
Turn-off Switching Waveforms & definition of t_{Eoff}

$P_{off} (100\%) =$	16,97	kW
$E_{off} (100\%) =$	1,55	mJ
$t_{Eoff} =$	0,42	μ s

Figure 6 Boost IGBT

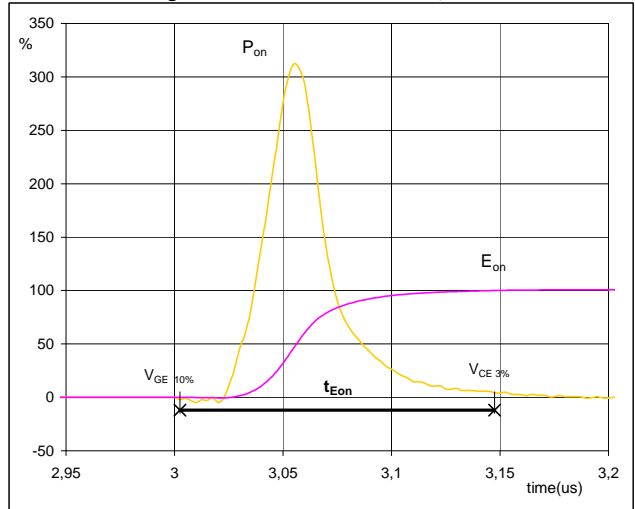
Turn-on Switching Waveforms & definition of t_{Eon}

$P_{on} (100\%) =$	16,97	kW
$E_{on} (100\%) =$	1,85	mJ
$t_{Eon} =$	0,14	μ s

Figure 7 Boost IGBT

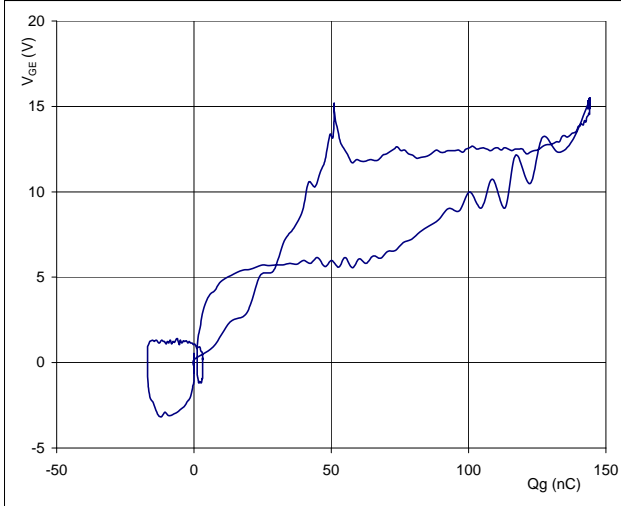
Gate voltage vs Gate charge (measured)

$V_{GEoff} =$	0	V
$V_{GEon} =$	15	V
$V_C (100\%) =$	700	V
$I_C (100\%) =$	24	A
$Q_g =$	144,01	nC

Figure 8 Boost FWD

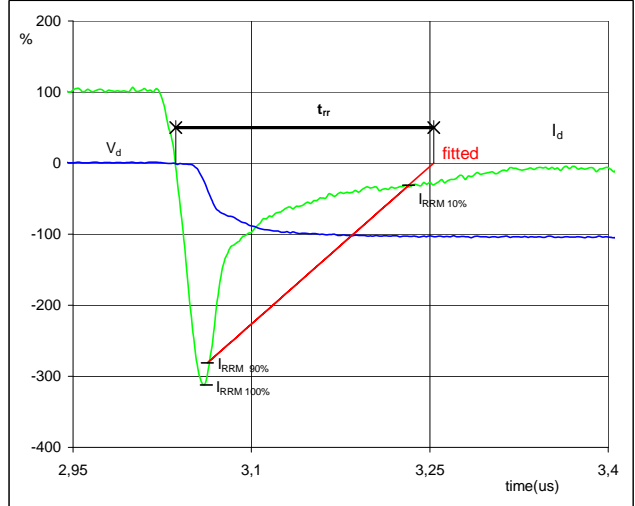
Turn-off Switching Waveforms & definition of t_{rr}

$V_d (100\%) =$	700	V
$I_d (100\%) =$	24	A
$I_{RRM} (100\%) =$	-76	A
$t_{rr} =$	0,21	μ s

Switching Definitions BOOST FWD

Figure 9 Boost FWD

Turn-on Switching Waveforms & definition of t_{Qrr}
 (t_{Qrr} = integrating time for Q_{rr})

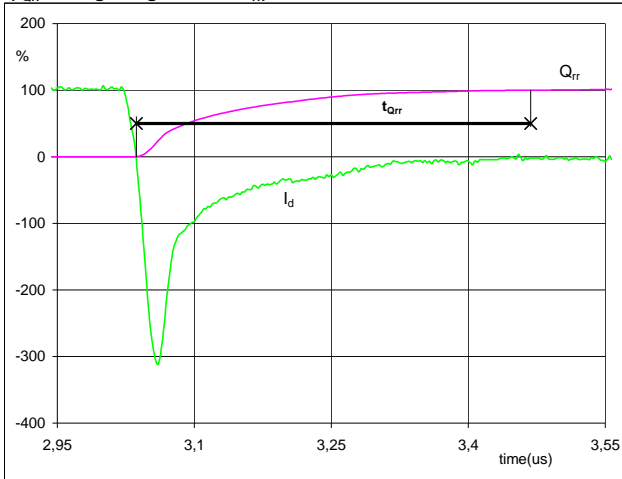

I_d (100%) =	24	A
Q_{rr} (100%) =	4,94	μC
t_{Qrr} =	0,43	μs

Figure 10 Boost FWD

Turn-on Switching Waveforms & definition of t_{Erec}
 (t_{Erec} = integrating time for E_{rec})

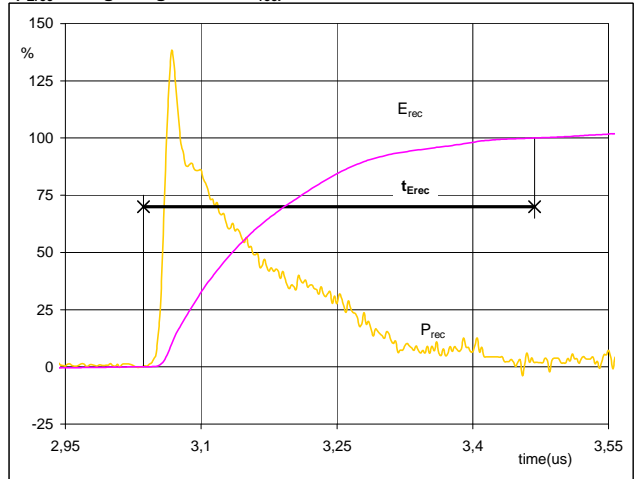

P_{rec} (100%) =	16,97	kW
E_{rec} (100%) =	2,36	mJ
t_{Erec} =	0,43	μs

Ordering Code and Marking - Outline - Pinout
Ordering Code & Marking

Version	Ordering Code	in DataMatrix as	in packaging barcode as
without thermal paste 17mm housing	V23990-P629-L59-PM	P629-L59-PM	P629-L59-PM

Outline

Pin table		
Pin	X	Y
1	0	22,5
2	2,9	22,5
3	8,3	22,5
4	10,8	22,5
5	19,6	22,5
6	22,1	22,5
7	29,1	22,5
8	32	22,5
9	33,5	17,8
10	33,5	15,3
11	33,5	7,2
12	33,5	4,7
13	32	0
14	29,1	0
15	22,1	0
16	19,6	0
17	10,8	0
18	8,3	0
19	2,9	0
20	0	0
21	0	8
22	0	14,5

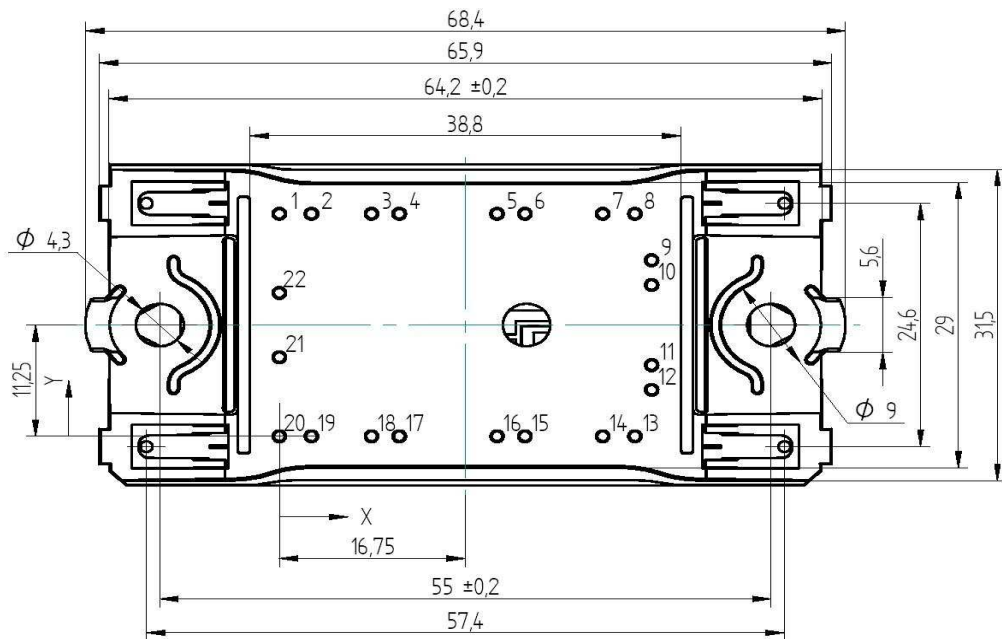
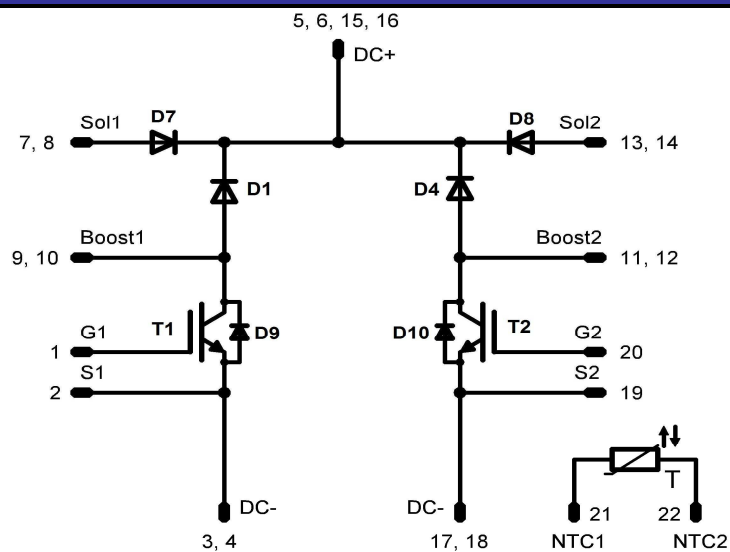
Pinout

PRODUCT STATUS DEFINITIONS

Datasheet Status	Product Status	Definition
Target	Formative or In Design	This datasheet contains the design specifications for product development. Specifications may change in any manner without notice. The data contained is exclusively intended for technically trained staff.
Preliminary	First Production	This datasheet contains preliminary data, and supplementary data may be published at a later date. Vincotech reserves the right to make changes at any time without notice in order to improve design. The data contained is exclusively intended for technically trained staff.
Final	Full Production	This datasheet contains final specifications. Vincotech reserves the right to make changes at any time without notice in order to improve design. The data contained is exclusively intended for technically trained staff.

DISCLAIMER

The information given in this datasheet describes the type of component and does not represent assured characteristics. For tested values please contact Vincotech. Vincotech reserves the right to make changes without further notice to any products herein to improve reliability, function or design. Vincotech does not assume any liability arising out of the application or use of any product or circuit described herein; neither does it convey any license under its patent rights, nor the rights of others.

LIFE SUPPORT POLICY

Vincotech products are not authorised for use as critical components in life support devices or systems without the express written approval of Vincotech.

As used herein:

1. Life support devices or systems are devices or systems which, (a) are intended for surgical implant into the body, or (b) support or sustain life, or (c) whose failure to perform when properly used in accordance with instructions for use provided in labelling can be reasonably expected to result in significant injury to the user.
2. A critical component is any component of a life support device or system whose failure to perform can be reasonably expected to cause the failure of the life support device or system, or to affect its safety or effectiveness.