

## Single Switch MOSFET Power Module

$V_{DSS} = 100V$   
 $R_{DSon} = 1.5m\Omega \text{ typ @ } T_j = 25^\circ C$   
 $I_D = 860A^* \text{ @ } T_c = 25^\circ C$

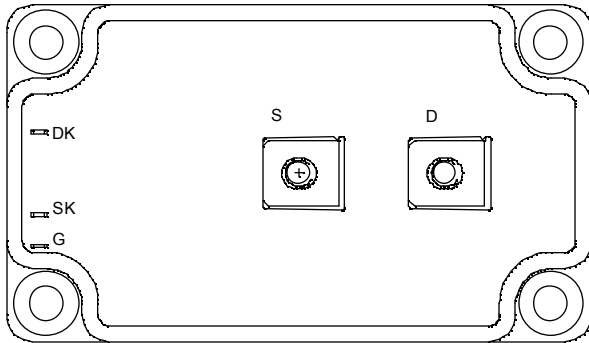
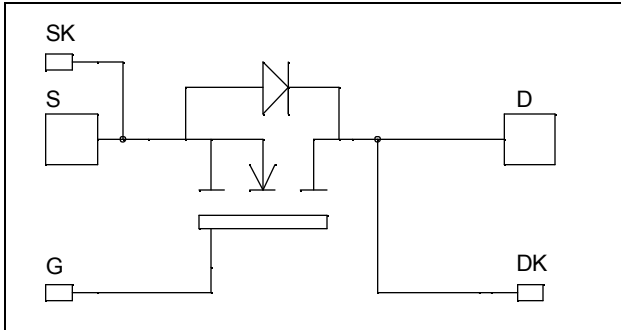

### Application

- Welding converters
- Switched Mode Power Supplies
- Uninterruptible Power Supplies
- Motor control

### Features

- Power MOS V<sup>®</sup> FREDFETs
  - Low  $R_{DSon}$
  - Low input and Miller capacitance
  - Low gate charge
  - Avalanche energy rated
  - Fast intrinsic diode
  - Very rugged
- Kelvin source for easy drive
- Very low stray inductance
  - Symmetrical design
  - M5 power connectors
- High level of integration
- AlN substrate for improved thermal performance

### Benefits

- Outstanding performance at high frequency operation
- Direct mounting to heatsink (isolated package)
- Low junction to case thermal resistance
- Low profile
- RoHS Compliant

### Absolute maximum ratings

Symbol	Parameter	Max ratings	Unit
$V_{DSS}$	Drain - Source Breakdown Voltage	100	V
$I_D$	Continuous Drain Current	$T_c = 25^\circ C$	860 *
		$T_c = 80^\circ C$	640 *
$I_{DM}$	Pulsed Drain current	2200	
$V_{GS}$	Gate - Source Voltage	$\pm 30$	V
$R_{DSon}$	Drain - Source ON Resistance	1.6	$m\Omega$
$P_D$	Maximum Power Dissipation	$T_c = 25^\circ C$	2500
$I_{AR}$	Avalanche current (repetitive and non repetitive)	100	A
$E_{AR}$	Repetitive Avalanche Energy	50	mJ
$E_{AS}$	Single Pulse Avalanche Energy	3000	

\* Specification of MOSFET device but output current must be limited to 500A to not exceed a delta of temperature greater than 100°C for the connectors.

**CAUTION:** These Devices are sensitive to Electrostatic Discharge. Proper Handling Procedures Should Be Followed. See application note APT0502 on [www.microsemi.com](http://www.microsemi.com)

All ratings @  $T_j = 25^\circ\text{C}$  unless otherwise specified

**Electrical Characteristics**

Symbol	Characteristic	Test Conditions	Min	Typ	Max	Unit
$I_{DSS}$	Zero Gate Voltage Drain Current	$V_{GS} = 0V, V_{DS} = 100V$			500	$\mu\text{A}$
		$V_{GS} = 0V, V_{DS} = 80V$			2000	
$R_{DS(on)}$	Drain – Source on Resistance	$V_{GS} = 10V, I_D = 275A$		1.5	1.6	$\text{m}\Omega$
$V_{GS(th)}$	Gate Threshold Voltage	$V_{GS} = V_{DS}, I_D = 12\text{mA}$	2		4	V
$I_{GSS}$	Gate – Source Leakage Current	$V_{GS} = \pm 30V, V_{DS} = 0V$			$\pm 450$	nA

**Dynamic Characteristics**

Symbol	Characteristic	Test Conditions	Min	Typ	Max	Unit
$C_{iss}$	Input Capacitance	$V_{GS} = 0V$		60		nF
$C_{oss}$	Output Capacitance	$V_{DS} = 25V$		23		
$C_{rss}$	Reverse Transfer Capacitance	$f = 1\text{MHz}$		8.8		
$Q_g$	Total gate Charge	$V_{GS} = 10V$		2100		nC
$Q_{gs}$	Gate – Source Charge	$V_{Bus} = 50V$		360		
$Q_{gd}$	Gate – Drain Charge	$I_D = 550A$		1080		
$T_{d(on)}$	Turn-on Delay Time	<b>Inductive switching</b> $V_{GS} = 15V$ $V_{Bus} = 66V$ $I_D = 550A$ $R_G = 1\Omega$		185		ns
$T_r$	Rise Time			270		
$T_{d(off)}$	Turn-off Delay Time			600		
$T_f$	Fall Time			175		
$E_{on}$	Turn-on Switching Energy	<b>Inductive switching @ 25°C</b> $V_{GS} = 15V, V_{Bus} = 66V$ $I_D = 550A, R_G = 1\Omega$		3.3		mJ
$E_{off}$	Turn-off Switching Energy			3.6		
$E_{on}$	Turn-on Switching Energy	<b>Inductive switching @ 125°C</b> $V_{GS} = 15V, V_{Bus} = 66V$ $I_D = 550A, R_G = 1\Omega$		3.65		mJ
$E_{off}$	Turn-off Switching Energy			3.85		

**Source - Drain diode ratings and characteristics**

Symbol	Characteristic	Test Conditions	Min	Typ	Max	Unit	
$I_S$	Continuous Source current (Body diode)	$T_c = 25^\circ\text{C}$			860*	A	
		$T_c = 80^\circ\text{C}$			640*		
$V_{SD}$	Diode Forward Voltage	$V_{GS} = 0V, I_S = -550A$			1.3	V	
$dv/dt$	Peak Diode Recovery ①				5	V/ns	
$t_{rr}$	Reverse Recovery Time	$I_S = -550A$ $V_R = 66V$ $di/dt = 600A/\mu\text{s}$	$T_j = 25^\circ\text{C}$			190	ns
			$T_j = 125^\circ\text{C}$			370	
$Q_{rr}$	Reverse Recovery Charge	$I_S = -550A$ $V_R = 66V$ $di/dt = 600A/\mu\text{s}$	$T_j = 25^\circ\text{C}$		2.4	$\mu\text{C}$	
			$T_j = 125^\circ\text{C}$		10.2		

 ①  $dv/dt$  numbers reflect the limitations of the circuit rather than the device itself.

$$I_S \leq -860A \quad di/dt \leq 600A/\mu\text{s} \quad V_R \leq V_{DSS} \quad T_j \leq 150^\circ\text{C}$$



## Typical Performance Curve

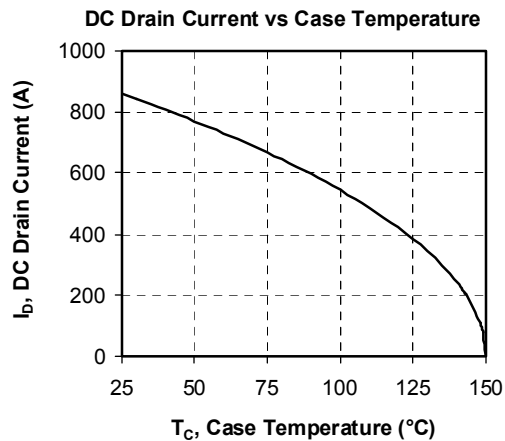
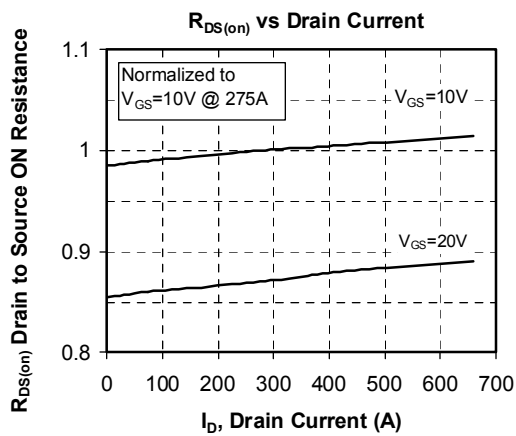
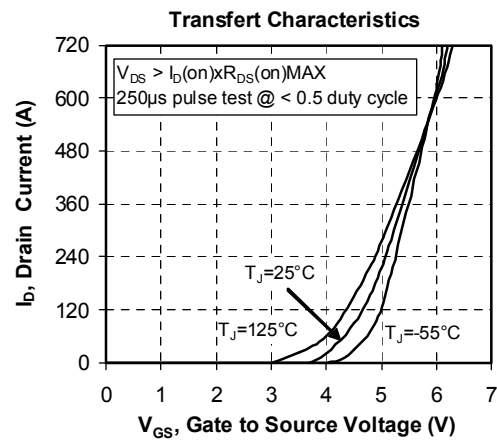
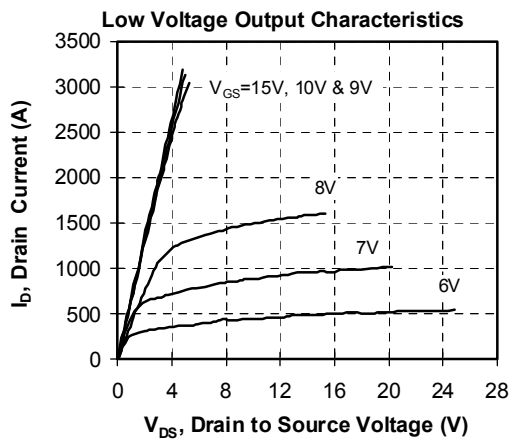
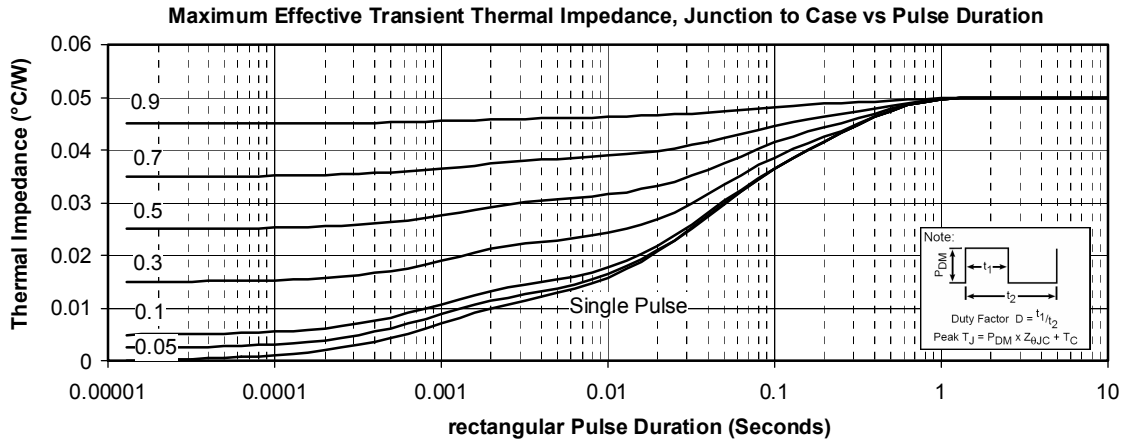

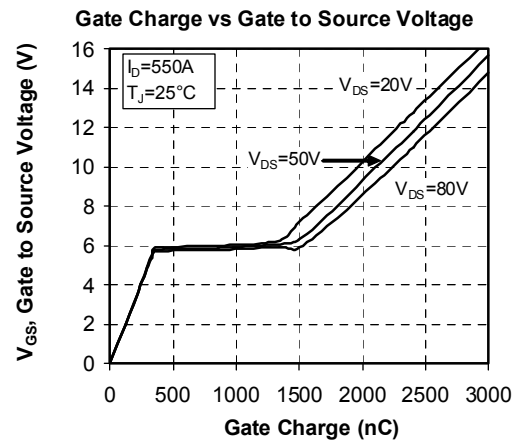
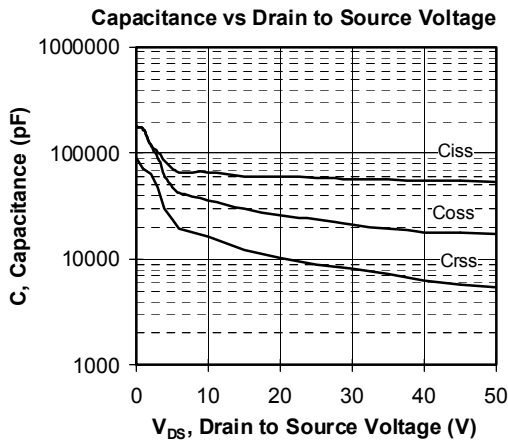
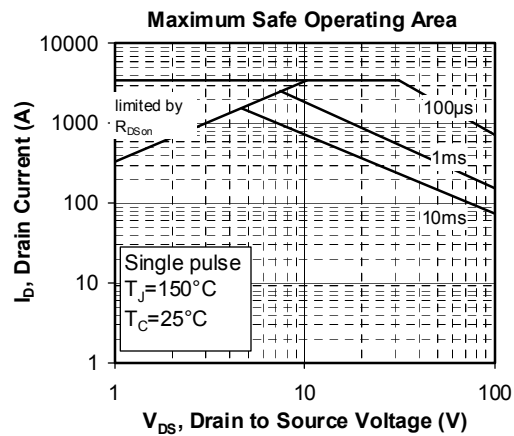
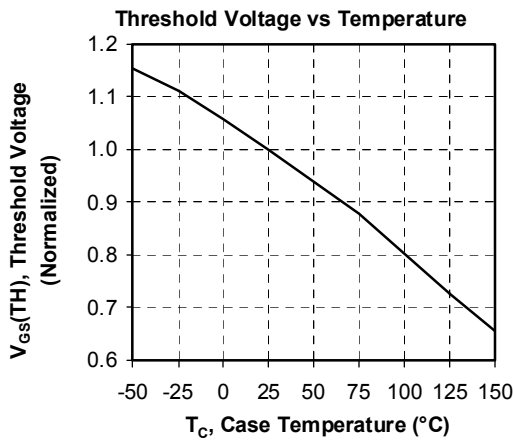
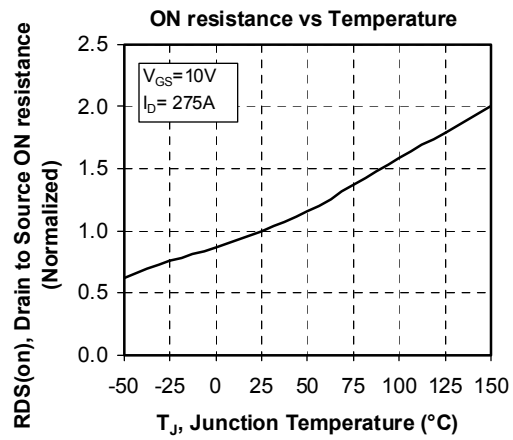
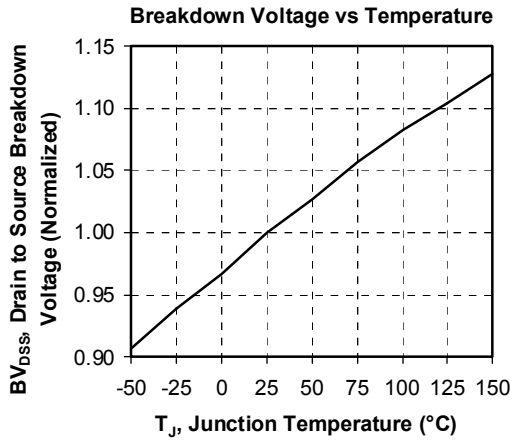

**Delay Times vs Current**

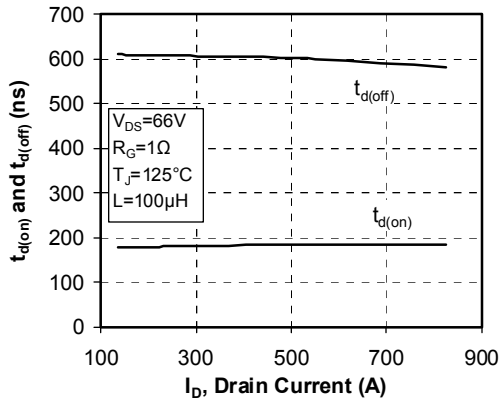

**Rise and Fall times vs Current**

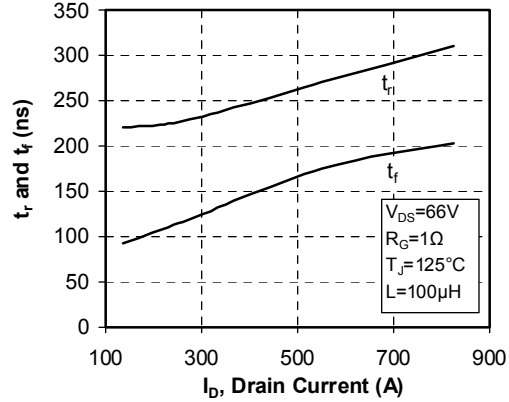

**Switching Energy vs Current**

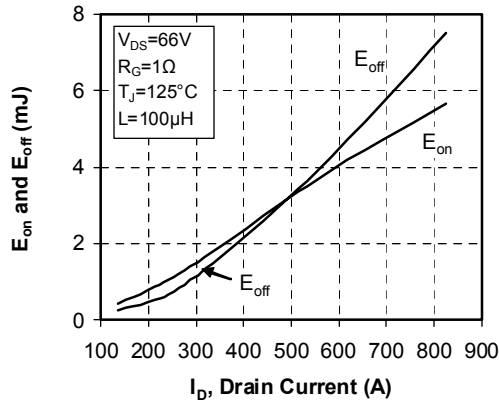

**Switching Energy vs Gate Resistance**

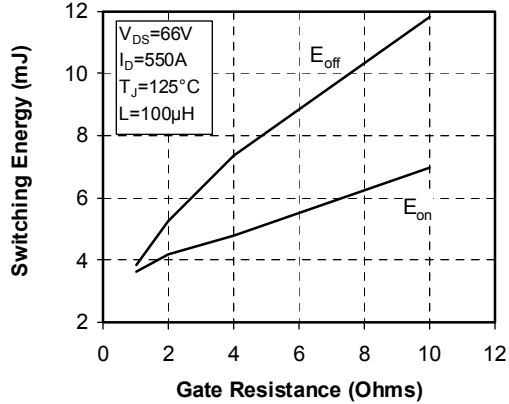

**Operating Frequency vs Drain Current**

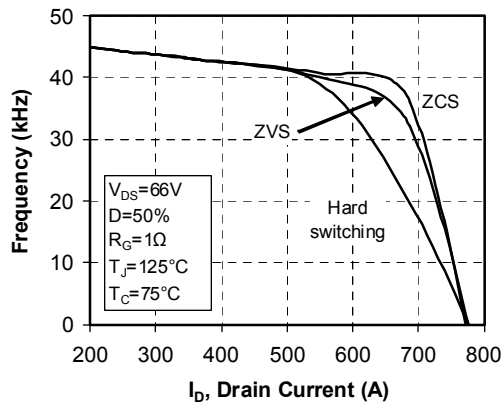

**Source to Drain Diode Forward Voltage**

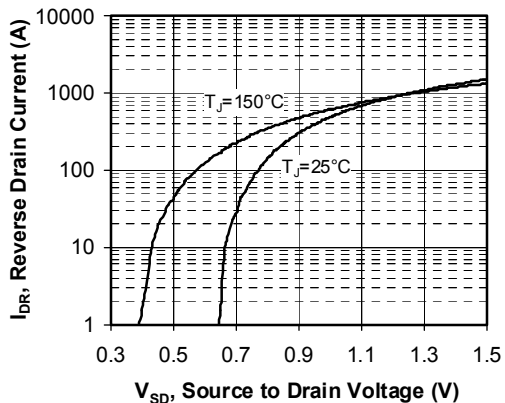

Microsemi reserves the right to change, without notice, the specifications and information contained herein

Microsemi's products are covered by one or more of U.S. patents 4,895,810 5,045,903 5,089,434 5,182,234 5,019,522 5,262,336 6,503,786 5,256,583 4,748,103 5,283,202 5,231,474 5,434,095 5,528,058 and foreign patents. U.S. and Foreign patents pending. All Rights Reserved.