

# SEMiX703GB126HDs



SEMiX® 3s

## Trench IGBT Modules

### SEMiX703GB126HDs

#### Features

- Homogeneous Si
- Trench = Trenchgate technology
- $V_{CE(sat)}$  with positive temperature coefficient
- High short circuit capability
- UL recognised file no. E63532

#### Typical Applications\*

- AC inverter drives
- UPS
- Electronic Welding

#### Remarks

- Case temperatur limited to  $T_C=125^\circ\text{C}$  max.
- Not for new design



GB

Absolute Maximum Ratings				
Symbol	Conditions	Values	Unit	
<b>IGBT</b>				
$V_{CES}$	$T_j = 25^\circ\text{C}$	1200	V	
$I_C$	$T_j = 150^\circ\text{C}$	$T_c = 25^\circ\text{C}$	642	A
		$T_c = 80^\circ\text{C}$	449	A
$I_{Cnom}$		450	A	
$I_{CRM}$	$I_{CRM} = 2 \times I_{Cnom}$	900	A	
$V_{GES}$		-20 ... 20	V	
$t_{psc}$	$V_{CC} = 600\text{ V}$ $V_{GE} \leq 20\text{ V}$ $V_{CES} \leq 1200\text{ V}$	$T_j = 125^\circ\text{C}$	10	$\mu\text{s}$
$T_j$		-40 ... 150	$^\circ\text{C}$	
<b>Inverse diode</b>				
$I_F$	$T_j = 150^\circ\text{C}$	$T_c = 25^\circ\text{C}$	561	A
		$T_c = 80^\circ\text{C}$	384	A
$I_{Fnom}$		450	A	
$I_{FRM}$	$I_{FRM} = 2 \times I_{Fnom}$	900	A	
$I_{FSM}$	$t_p = 10\text{ ms, sin } 180^\circ, T_j = 25^\circ\text{C}$	2900	A	
$T_j$		-40 ... 150	$^\circ\text{C}$	
<b>Module</b>				
$I_{t(RMS)}$	$T_{terminal} = 80^\circ\text{C}$	600	A	
$T_{stg}$		-40 ... 125	$^\circ\text{C}$	
$V_{isol}$	AC sinus 50Hz, $t = 1\text{ min}$	4000	V	

Characteristics					
Symbol	Conditions	min.	typ.	max.	Unit
<b>IGBT</b>					
$V_{CE(sat)}$	$I_C = 450\text{ A}$ $V_{GE} = 15\text{ V}$ chipelevel	$T_j = 25^\circ\text{C}$	1.7	2.10	V
		$T_j = 125^\circ\text{C}$	2.0	2.45	V
$V_{CE0}$	chipelevel	$T_j = 25^\circ\text{C}$	1	1.2	V
		$T_j = 125^\circ\text{C}$	0.9	1.1	V
$r_{CE}$	$V_{GE} = 15\text{ V}$ chipelevel	$T_j = 25^\circ\text{C}$	1.6	2.0	$\text{m}\Omega$
		$T_j = 125^\circ\text{C}$	2.4	3.0	$\text{m}\Omega$
$V_{GE(th)}$	$V_{GE}=V_{CE}, I_C = 18\text{ mA}$	5	5.8	6.5	V
$I_{CES}$	$V_{GE} = 0\text{ V}$ $V_{CE} = 1200\text{ V}$	$T_j = 25^\circ\text{C}$		5	mA
		$T_j = 125^\circ\text{C}$			mA
$C_{ies}$	$V_{CE} = 25\text{ V}$		32.3		nF
$C_{oes}$	$V_{GE} = 0\text{ V}$		1.69		nF
$C_{res}$			1.46		nF
$Q_G$	$V_{GE} = -8\text{ V...} + 15\text{ V}$		3600		nC
$R_{Gint}$	$T_j = 25^\circ\text{C}$		1.67		$\Omega$
$t_{d(on)}$	$V_{CC} = 600\text{ V}$ $I_C = 450\text{ A}$	$T_j = 125^\circ\text{C}$	310		ns
$t_r$	$V_{GE} = \pm 15\text{ V}$	$T_j = 125^\circ\text{C}$	60		ns
$E_{on}$	$R_{Gon} = 1.6\ \Omega$	$T_j = 125^\circ\text{C}$	32		mJ
$t_{d(off)}$	$R_{Goff} = 1.6\ \Omega$	$T_j = 125^\circ\text{C}$	680		ns
$t_f$		$T_j = 125^\circ\text{C}$	135		ns
$E_{off}$		$T_j = 125^\circ\text{C}$	68		mJ
$R_{th(j-c)}$	per IGBT			0.061	K/W

# SEMiX703GB126HDs



SEMiX® 3s

## Trench IGBT Modules

### SEMiX703GB126HDs

#### Features

- Homogeneous Si
- Trench = Trenchgate technology
- $V_{CE(sat)}$  with positive temperature coefficient
- High short circuit capability
- UL recognised file no. E63532

#### Typical Applications\*

- AC inverter drives
- UPS
- Electronic Welding

#### Remarks

- Case temperatur limited to  $T_C=125^\circ\text{C}$  max.
- Not for new design

Characteristics						
Symbol	Conditions		min.	typ.	max.	Unit
<b>Inverse diode</b>						
$V_F = V_{EC}$	$I_F = 450\text{ A}$ $V_{GE} = 0\text{ V}$ chipllevel	$T_j = 25\text{ }^\circ\text{C}$		1.6	1.80	V
		$T_j = 125\text{ }^\circ\text{C}$		1.6	1.8	V
$V_{F0}$	chipllevel	$T_j = 25\text{ }^\circ\text{C}$	0.9	1	1.1	V
		$T_j = 125\text{ }^\circ\text{C}$	0.7	0.8	0.9	V
$r_F$	chipllevel	$T_j = 25\text{ }^\circ\text{C}$	1.1	1.3	1.6	m $\Omega$
		$T_j = 125\text{ }^\circ\text{C}$	1.6	1.8	2.0	m $\Omega$
$I_{RRM}$	$I_F = 450\text{ A}$	$T_j = 125\text{ }^\circ\text{C}$		580		A
$Q_{rr}$	$di/dt_{off} = 8500\text{ A}/\mu\text{s}$	$T_j = 125\text{ }^\circ\text{C}$		130		$\mu\text{C}$
$E_{rr}$	$V_{GE} = -15\text{ V}$ $V_{CC} = 600\text{ V}$	$T_j = 125\text{ }^\circ\text{C}$		60		mJ
$R_{th(j-c)}$	per diode				0.11	K/W
<b>Module</b>						
$L_{CE}$				20		nH
$R_{CC'+EE'}$	res., terminal-chip	$T_C = 25\text{ }^\circ\text{C}$		0.7		m $\Omega$
		$T_C = 125\text{ }^\circ\text{C}$		1		m $\Omega$
$R_{th(c-s)}$	per module			0.04		K/W
$M_s$	to heat sink (M5)		3		5	Nm
$M_t$		to terminals (M6)	2.5		5	Nm
						Nm
$w$					300	g
<b>Temperature Sensor</b>						
$R_{100}$	$T_C=100^\circ\text{C}$ ( $R_{25}=5\text{ k}\Omega$ )			$493 \pm 5\%$		$\Omega$
$B_{100/125}$	$R_{(T)}=R_{100}\exp[B_{100/125}(1/T-1/T_{100})]$ ; $T[\text{K}]$ ;			$3550 \pm 2\%$		K

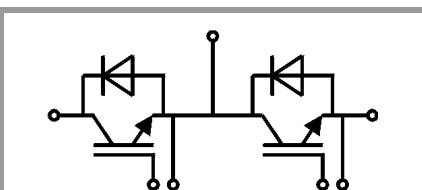

GB

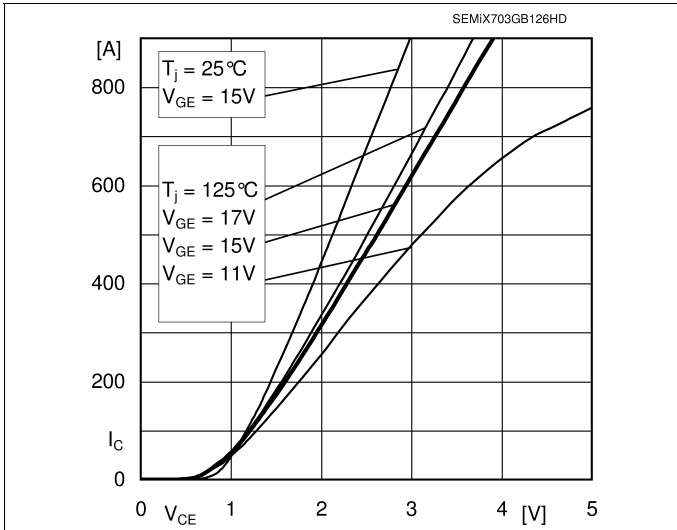

Fig. 1: Typ. output characteristic, inclusive  $R_{CC+EE}$

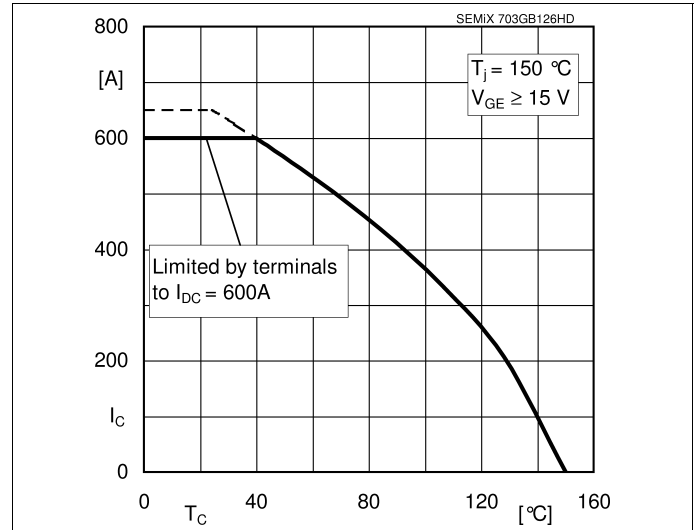

Fig. 2: Rated current vs. temperature  $I_C = f(T_C)$

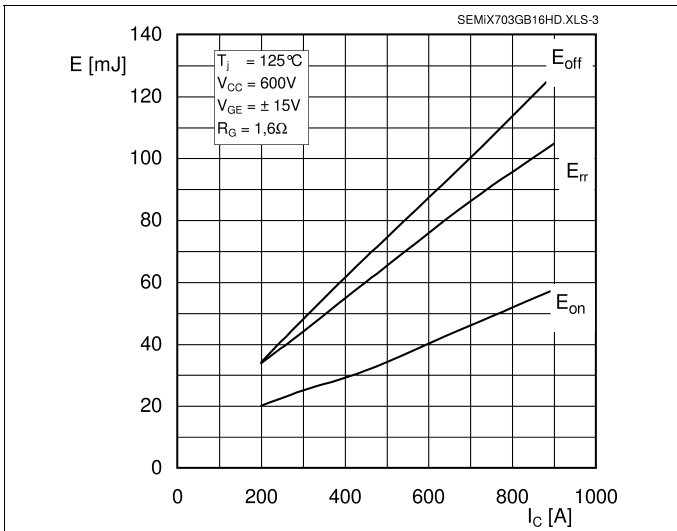

Fig. 3: Typ. turn-on /-off energy =  $f(I_C)$

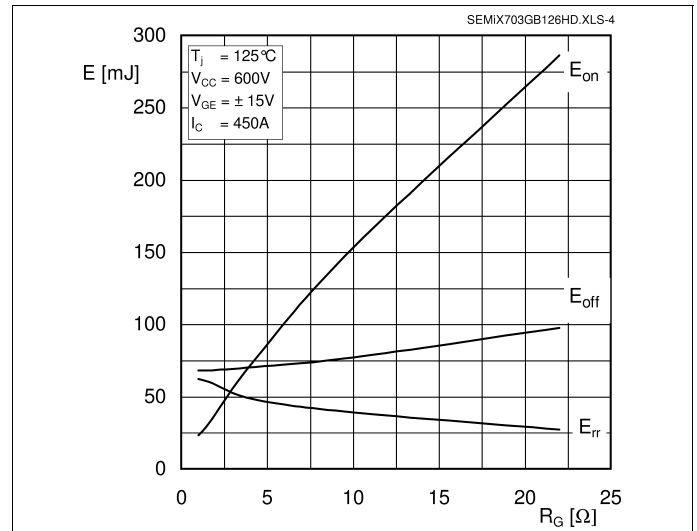

Fig. 4: Typ. turn-on /-off energy =  $f(R_G)$

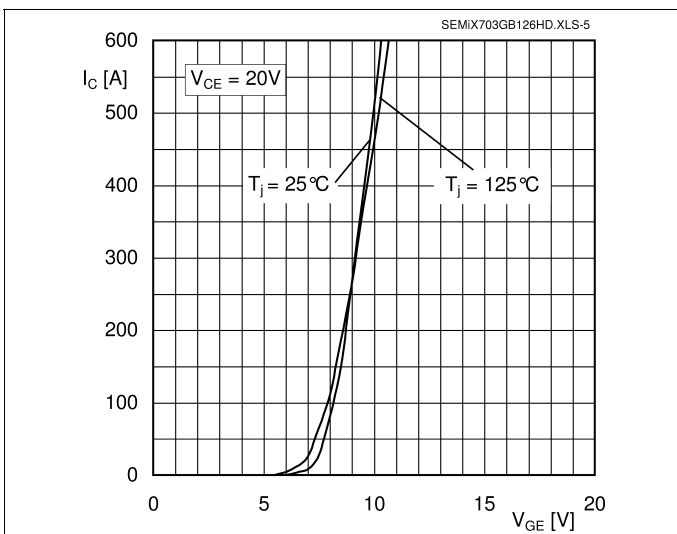

Fig. 5: Typ. transfer characteristic

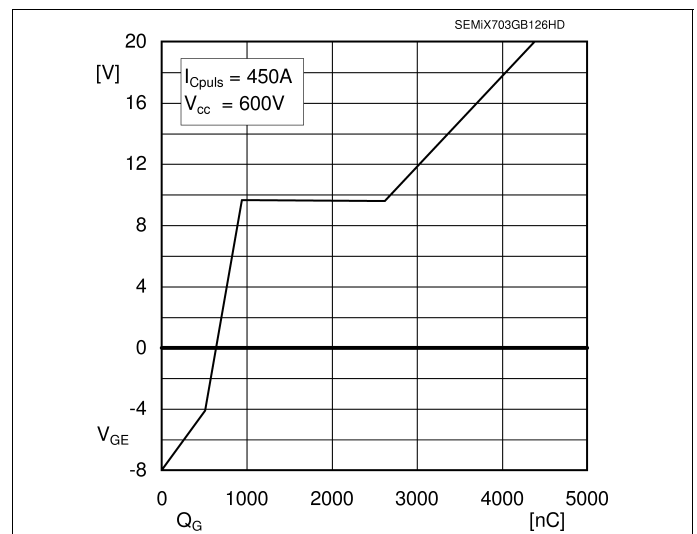

Fig. 6: Typ. gate charge characteristic

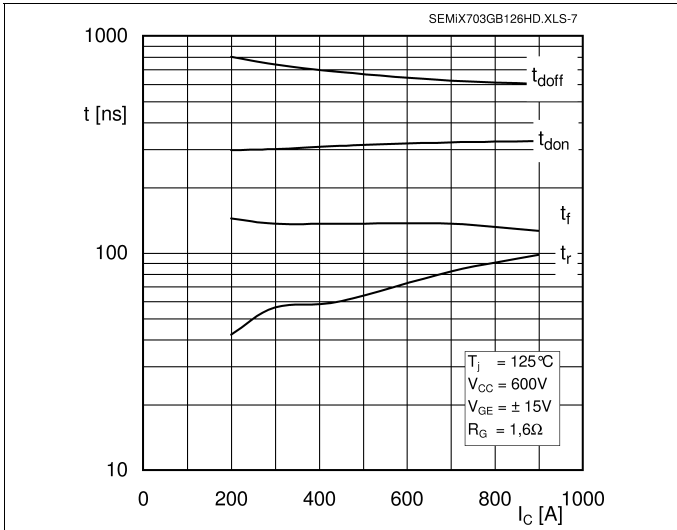

Fig. 7: Typ. switching times vs.  $I_C$

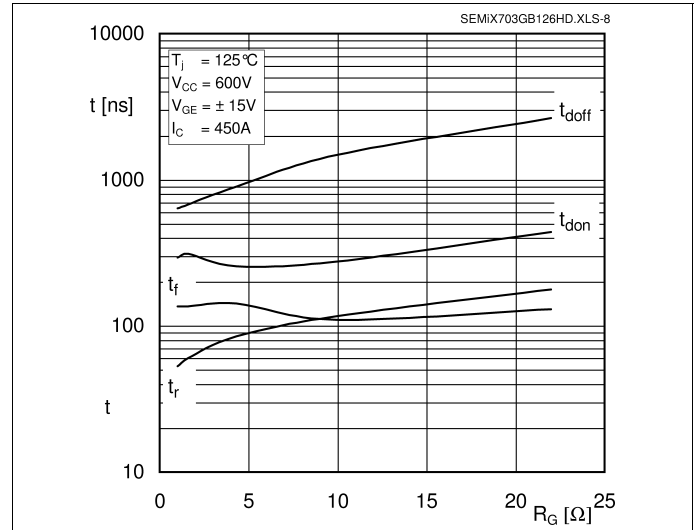

Fig. 8: Typ. switching times vs. gate resistor  $R_G$

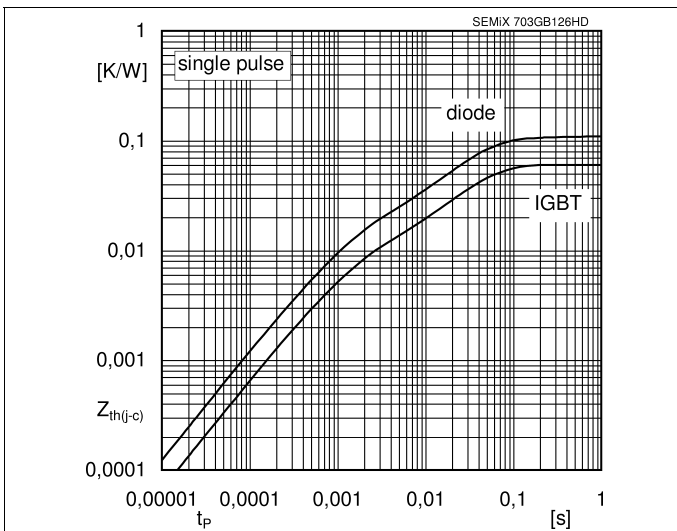

Fig. 9: Typ. transient thermal impedance

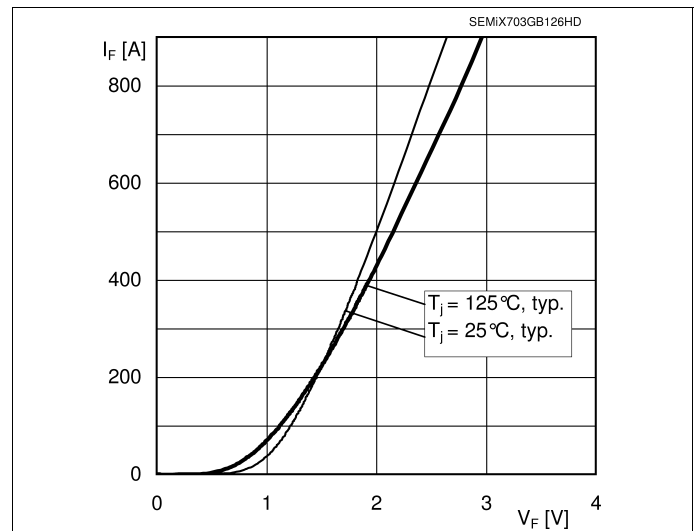

Fig. 10: Typ. CAL diode forward charact., incl.  $R_{CC+EE}$

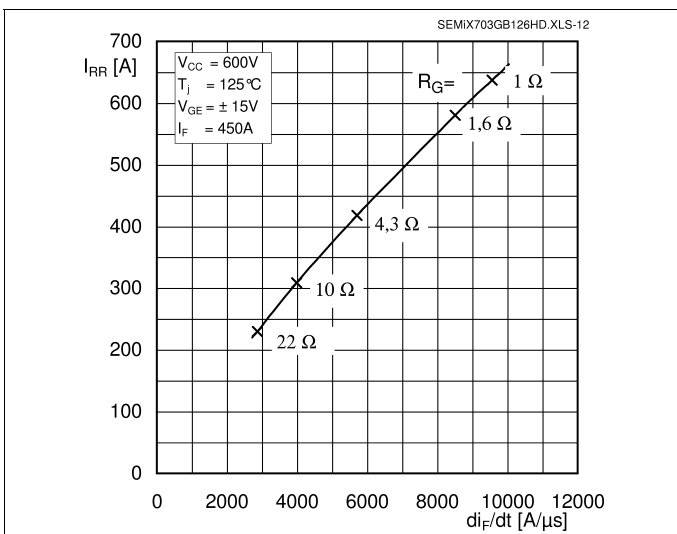

Fig. 11: Typ. CAL diode peak reverse recovery current

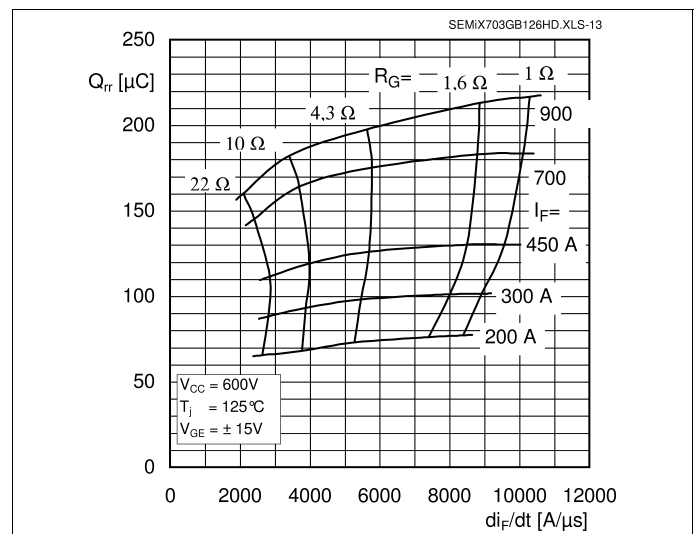
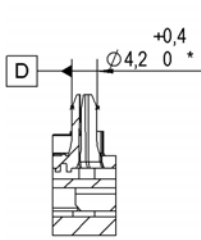

Fig. 12: Typ. CAL diode recovery charge

# SEMiX703GB126HDs

Case: SEMiX 3s

guide pin left  
F-F (1 : 1)



screw duct  
(1x centre):  
H-H (1 : 1)

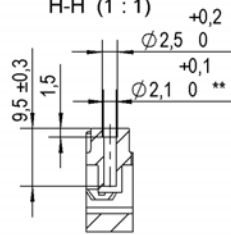

	0,3	connector 1-2 / 3-4
	0,2	each connector

general tolerance:  
ISO 2768-m  
ISO 8015

screw duct (6x)  
spring duct (16x):  
G-G (1 : 1)

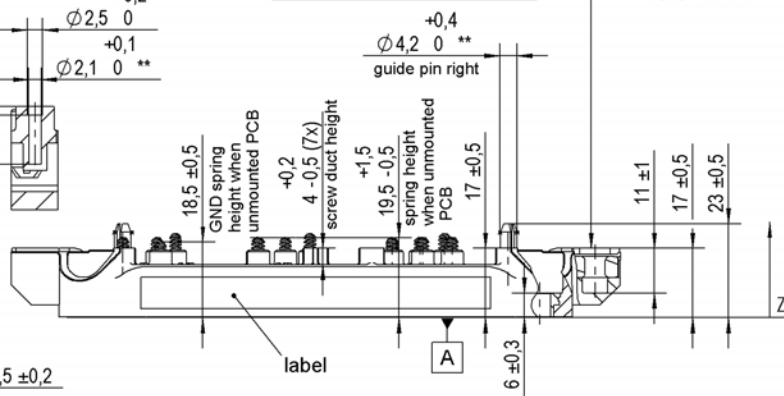
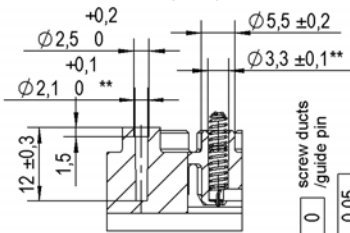

All measures in Z-direction  
valid when mounted to heat sink

marking of  
terminals

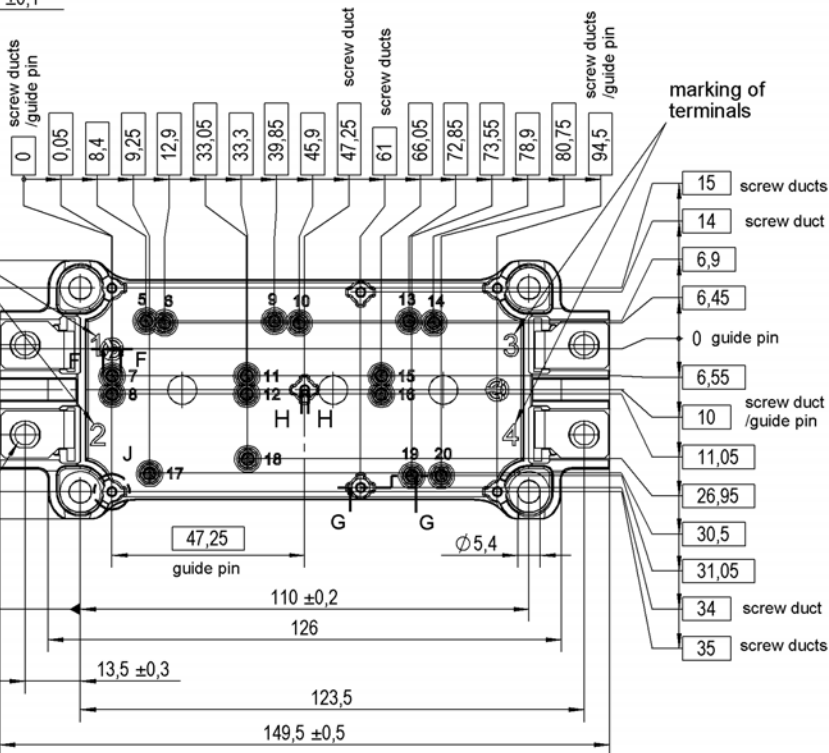
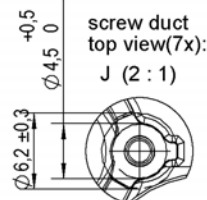
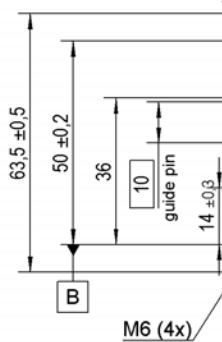

\*guide pin left with

	0,25	A	B	C
--	------	---	---	---

\*\*screw ducts / spring ducts / guide pin right with

	0,5	A	B	D
--	-----	---	---	---

Rules for the contact PCB:

- holes guidepins =  $\varnothing 4 \pm 0,1$  / position tolerance  $\pm 0,1$
- holes for screws =  $\varnothing 3,3 \pm 0,1$  / position tolerance  $\pm 0,1$
- spring contact pad =  $\varnothing 3,6 \pm 0,1$  / position tolerance  $\pm 0,1$

SEMiX 3s

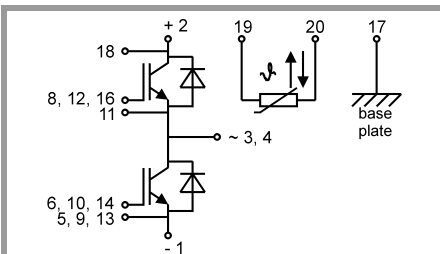

spring configuration

This is an electrostatic discharge sensitive device (ESDS), international standard IEC 60747-1, Chapter IX

\* The specifications of our components may not be considered as an assurance of component characteristics. Components have to be tested for the respective application. Adjustments may be necessary. The use of SEMIKRON products in life support appliances and systems is subject to prior specification and written approval by SEMIKRON. We therefore strongly recommend prior consultation of our staff.