

# Analog Devices Welcomes Hittite Microwave Corporation

NO CONTENT ON THE ATTACHED DOCUMENT HAS CHANGED



**THIS PAGE INTENTIONALLY LEFT BLANK**



# HMC977LP4E

## GaAs MMIC I/Q DOWNCONVERTER 20 - 28 GHz

### Typical Applications

The HMC977LP4E is ideal for:

- Point-to-Point and Point-to-Multi-Point Radio
- Military Radar, EW & ELINT
- Satellite Communications

### Features

- Conversion Gain: 14 dB
- Image Rejection: 21 dBc
- 2 LO to RF Isolation: 45 dB
- Noise Figure: 2.5 dB
- Input IP3: 1 dBm
- 24 Lead 4 x 4 mm SMT Package: 16 mm<sup>2</sup>

### Functional Diagram

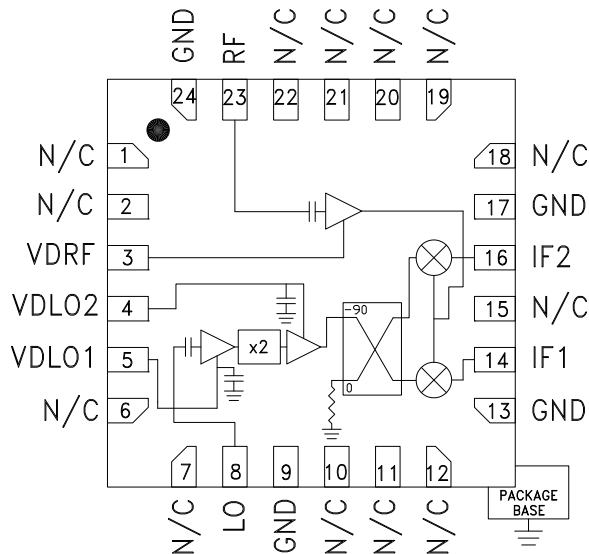

### General Description

The HMC977LP4E is a compact GaAs MMIC I/Q downconverter in a leadless RoHS compliant SMT package. This device provides a small signal conversion gain of 14 dB with a noise figure of 2.7 dB and 21 dBc of image rejection. The HMC977LP4E utilizes an LNA followed by an image reject mixer which is driven by an active x2 multiplier. The image reject mixer eliminates the need for a filter following the LNA, and removes thermal noise at the image frequency. I and Q mixer outputs are provided and an external 90° hybrid is needed to select the required sideband. The HMC977LP4E is a much smaller alternative to hybrid style image reject mixer downconverter assemblies, and is compatible with surface mount manufacturing techniques.

### Electrical Specifications, $T_A = +25\text{ }^\circ\text{C}$ , IF = 1000 MHz, LO = +6 dBm, Vdd = 4.5 Vdc USB [1]

Parameter	Min.	Typ.	Max.	Min.	Typ.	Max.	Units
Frequency Range, RF		20 - 26.5		26.5 - 28			GHz
Frequency Range, LO		8.3 - 15		11.5 - 15.7			GHz
Frequency Range, IF		DC - 3.5		DC - 3.5			GHz
Conversion Gain (As IRM)	11	14		11	14		dB
Noise Figure		2.5		3.0			dB
Image Rejection		21		20			dBc
1 dB Compression (Input)		-8		-7			dBm
2 LO to RF Isolation	35	45		34	39		dB
2 LO to IF Isolation		20		30			dB
IP3 (Input)		1		3			dBm
Amplitude Balance [2]		0.3		0.3			dB
Phase Balance [2]		17		12			deg
Total Supply Current		170	210	170	210		mA

[1] Data taken as IRM with external IF 90° hybrid

[2] Data taken without external 90° hybrid, IF = 500 MHz

For price, delivery and to place orders: Hittite Microwave Corporation, 20 Alpha Road, Chelmsford, MA 01824

Phone: 978-250-3343 Fax: 978-250-3373 Order On-line at [www.hittite.com](http://www.hittite.com)

Application Support: Phone: 978-250-3343 or [apps@hittite.com](mailto:apps@hittite.com)

Data Taken As IRM With External IF 90° Hybrid, IF = 1000 MHz

**Conversion Gain USB vs. Temperature**

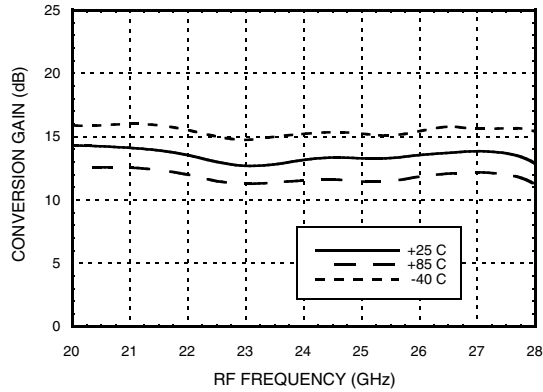

**Conversion Gain USB vs. LO Drive**

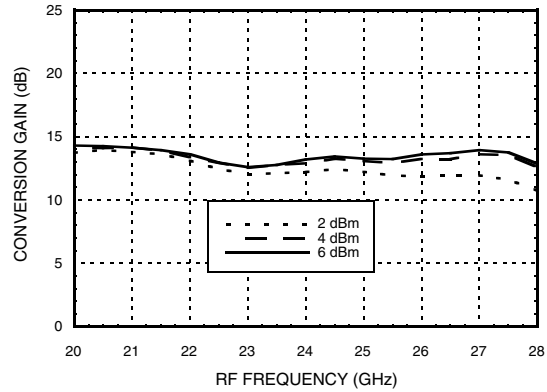

**Image Rejection vs. Temperature**

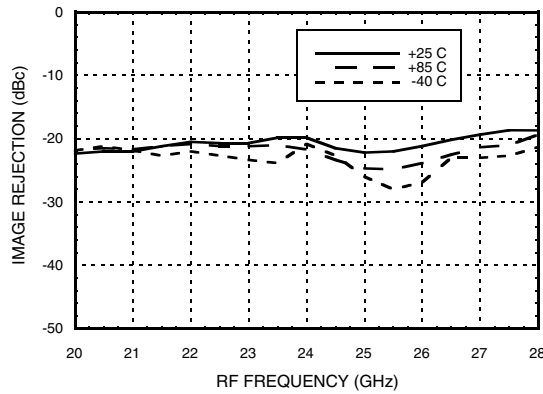

**RF Return Loss vs. Temperature**

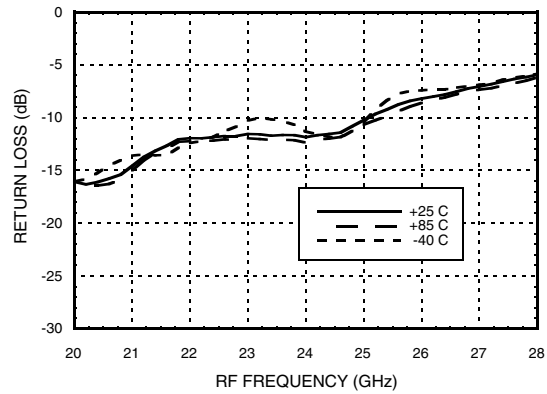

**LO Return Loss vs. Temperature**

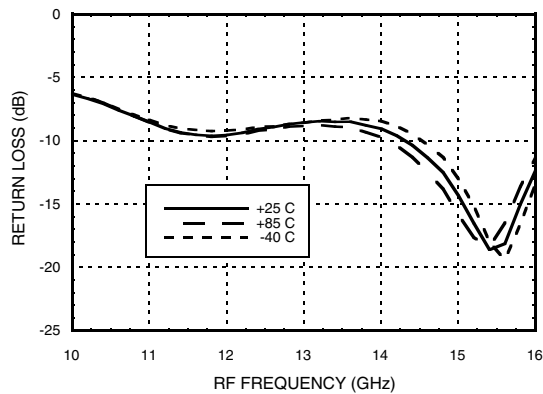

**IF Return Loss [1]**

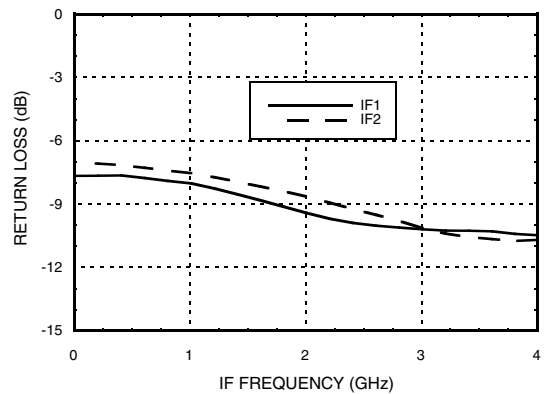

[1] Data taken without external 90° hybrid.

Data Taken as IRM With External IF 90° Hybrid, IF = 1000 MHz

### RF/IF and LO/IF Isolations

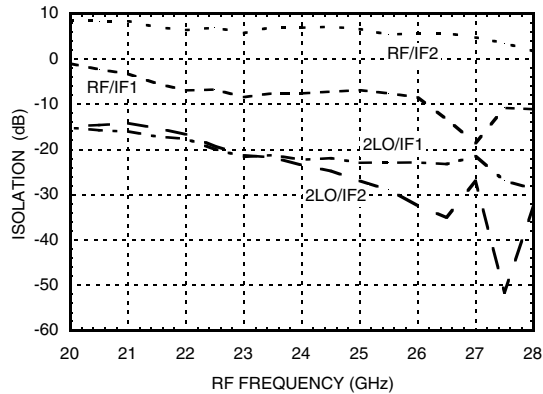

### LO/RF Isolations

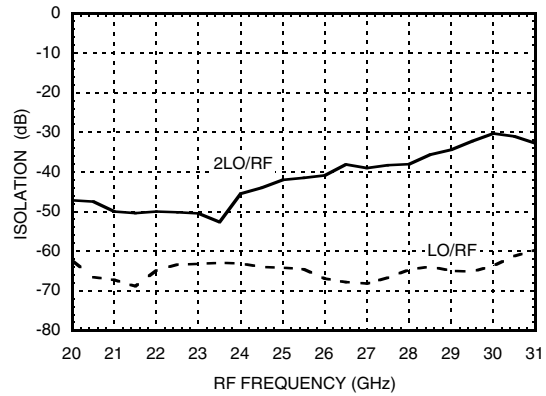

### Input P1dB USB vs. Temperature

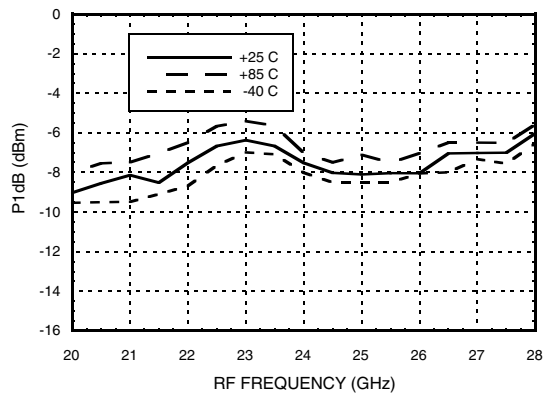

### Input IP3, USB vs. Temperature

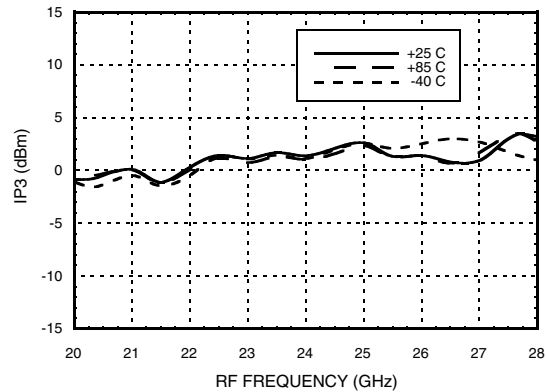

### Input IP3, USB vs. LO Drive

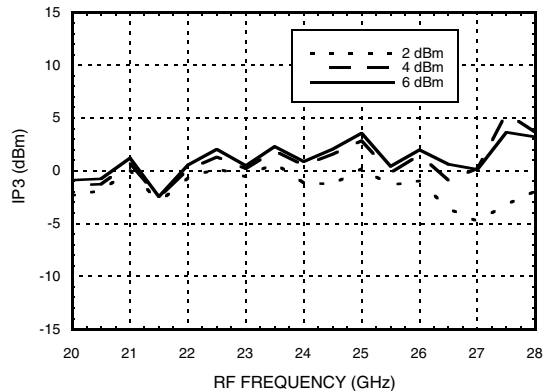

### Noise Figure, LO Frequency = 10 GHz

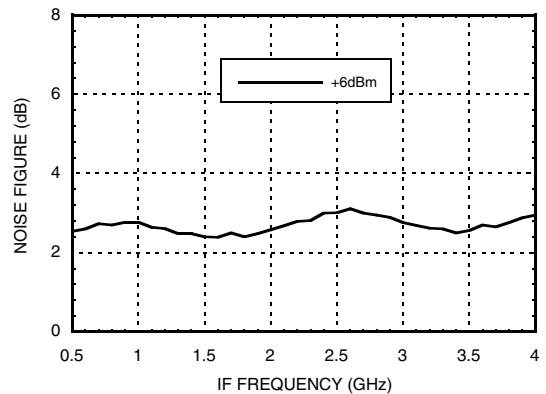

\* Conversion gain data taken with external IF 90° IF hybrid, LO frequency fixed at 8.5 GHz and RF varied

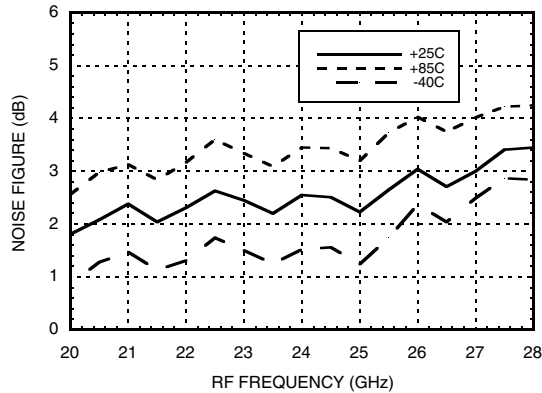
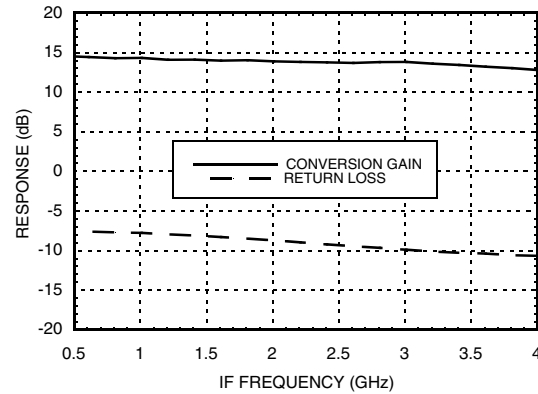
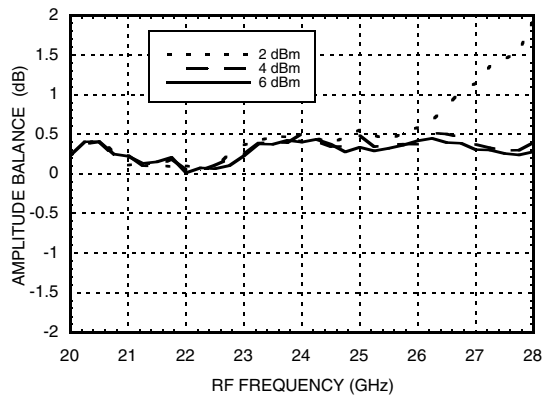
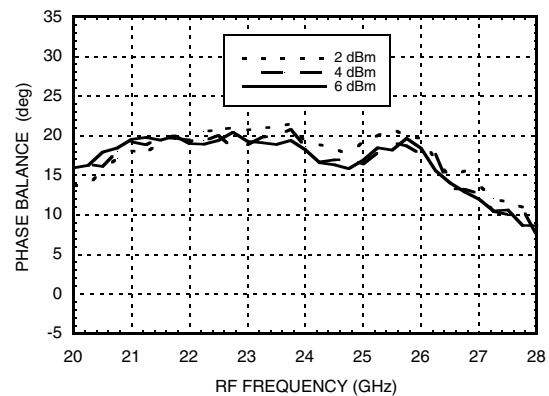
**Quadrature Channel Data Taken Without IF 90° Hybrid, IF = 1000 MHz**
**Noise Figure vs. Temperature,  
IF Frequency = 1000 MHz**

**IF Bandwidth**

**Amplitude Balance vs. LO Drive <sup>[1]</sup>**

**Phase Balance vs. LO Drive <sup>[1]</sup>**

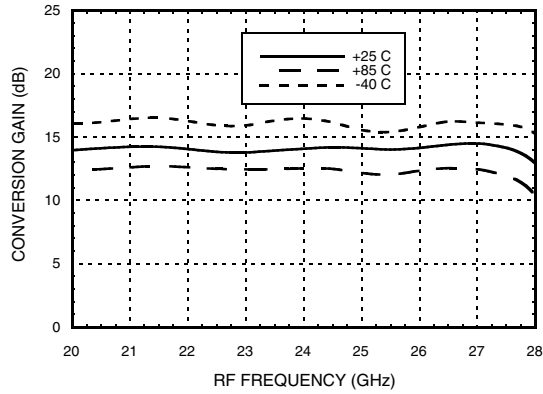
[1] Data taken with IF = 1000 MHz

Data Taken as IRM With External IF 90° Hybrid, IF = 1000 MHz

**Conversion Gain, LSB vs. Temperature**



**Conversion Gain, LSB vs. LO Drive**

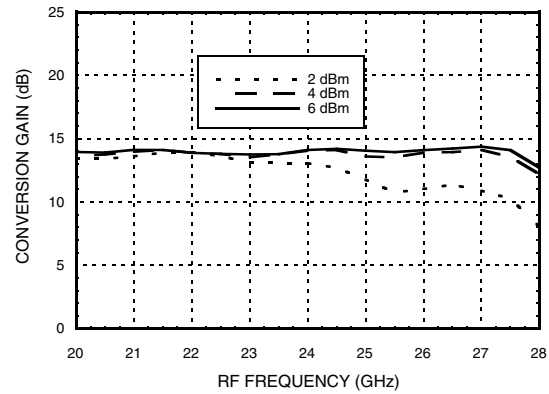

**Image Rejection vs. Temperature**

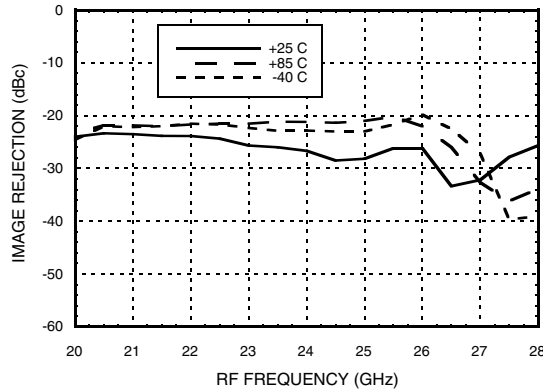

**Input P1dB, LSB vs. Temperature**

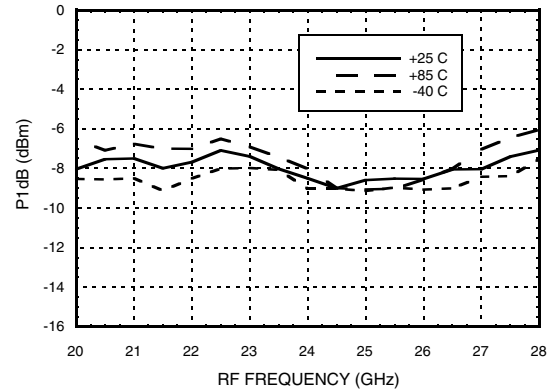

**Input IP3, LSB vs. Temperature**

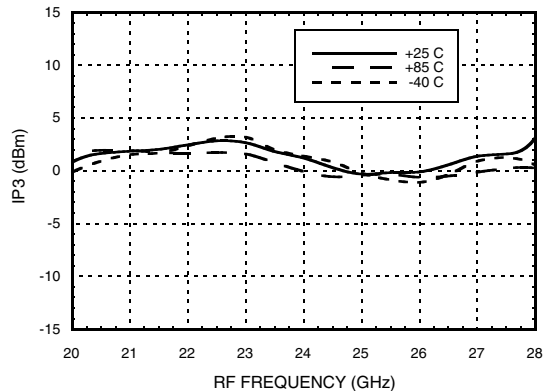

**Input IP3, LSB vs. LO Drive**

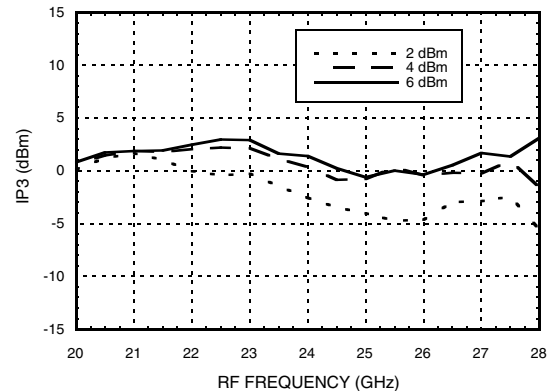

\* Conversion gain data taken with external IF 90° IF hybrid, LO frequency fixed at 8.5 GHz and RF varied

Data Taken as IRM With External IF 90° Hybrid, IF = 2000 MHz

**Conversion Gain, USB vs. Temperature**

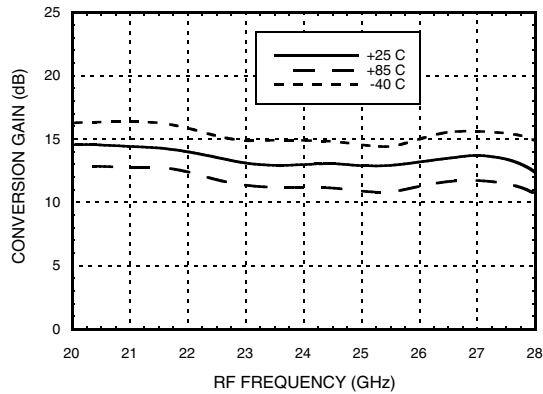

**Conversion Gain, USB vs. LO Drive**

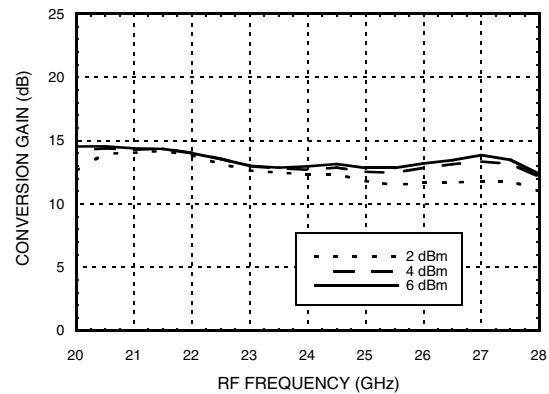

**Image Rejection vs. Temperature**

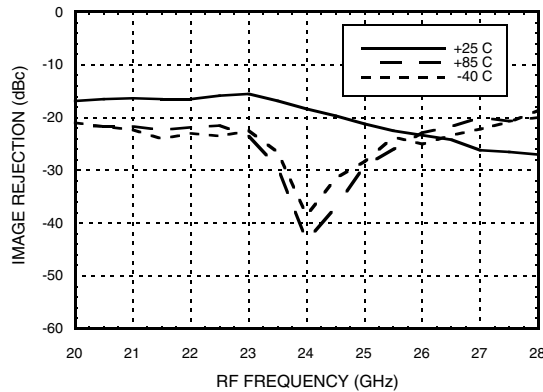

**Input IP3, USB vs. Temperature**

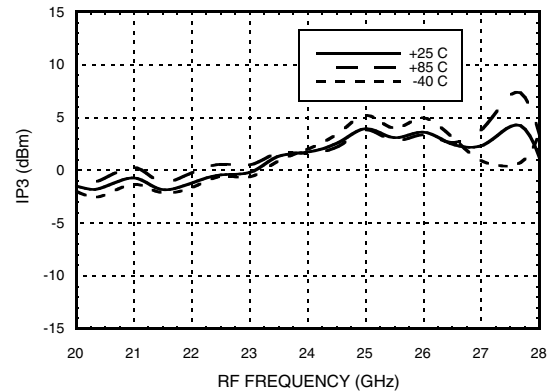

**Input IP3, USB vs. LO Drive**

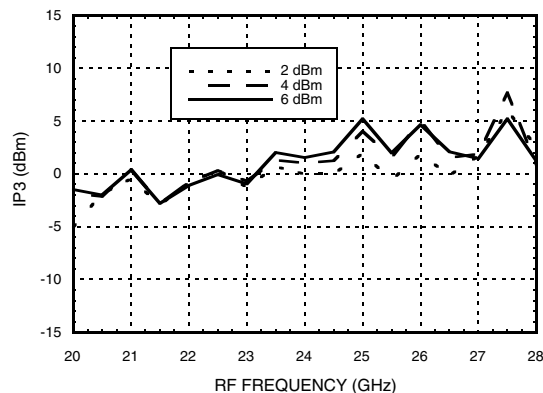

\* Conversion gain data taken with external IF 90° IF hybrid, LO frequency fixed at 8.5 GHz and RF varied



Data Taken as IRM With External IF 90° Hybrid, IF = 2000 MHz

**Conversion Gain, LSB vs. Temperature**

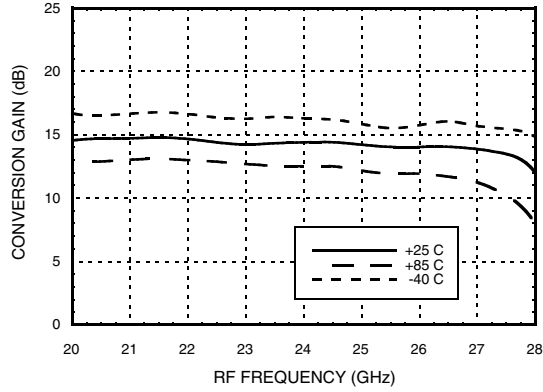

**Conversion Gain, LSB vs. LO Drive**

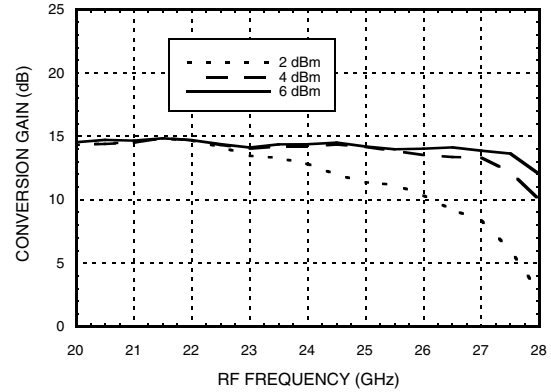

**Image Rejection vs. Temperature**

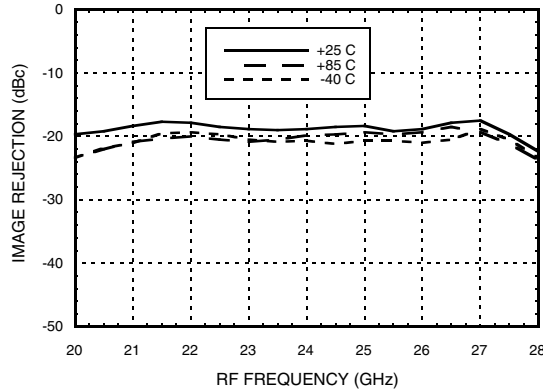

**Input IP3, LSB vs. Temperature**

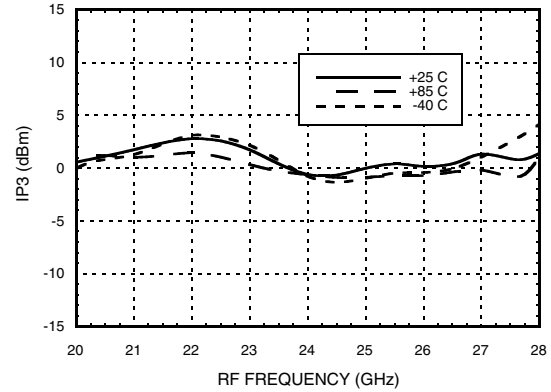

**Input IP3, LSB vs. LO Drive**

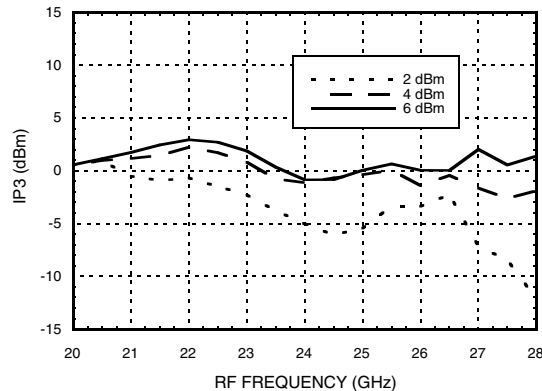



Data Taken as IRM With External IF 90° Hybrid, IF = 3300 MHz

**Conversion Gain, USB vs. Temperature**

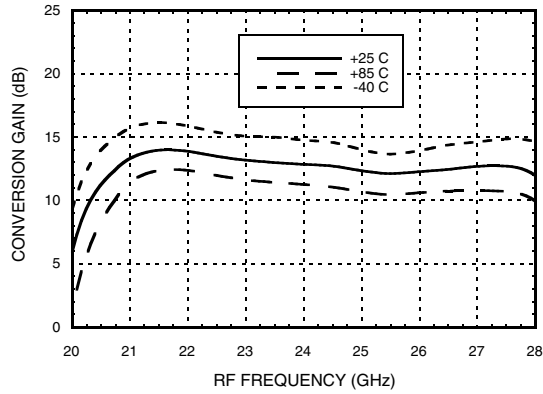

**Conversion Gain, USB vs. LO Drive**

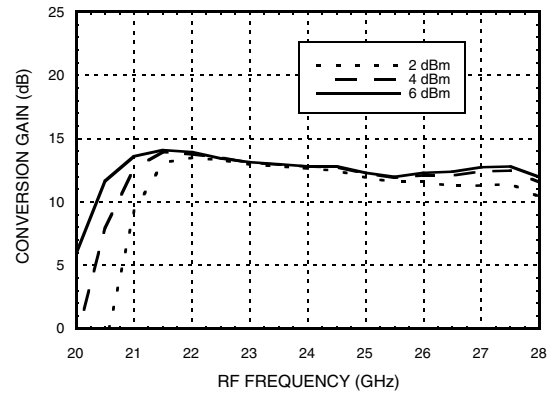

**Image Rejection vs. Temperature**

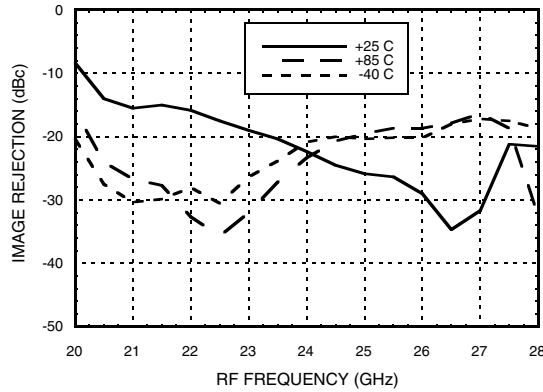

**Input IP3, USB vs. Temperature**

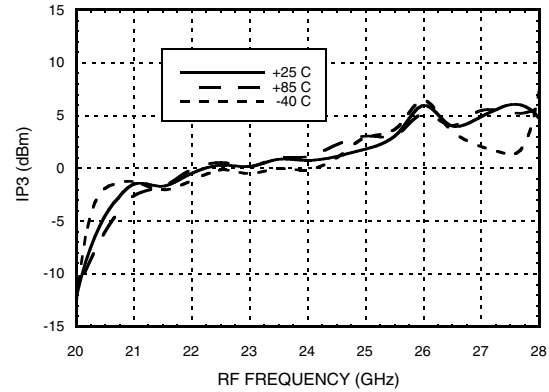

**Input IP3, USB vs. LO Drive**

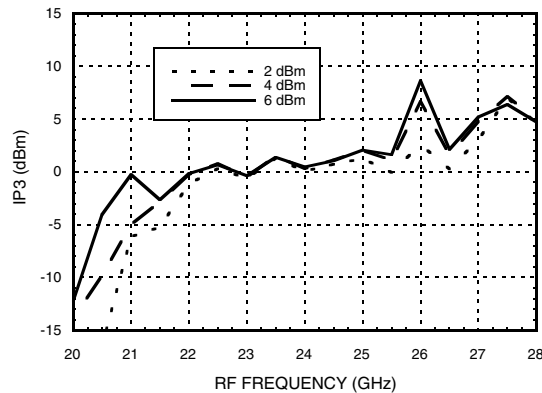

\* Conversion gain data taken with external IF 90° IF hybrid, LO frequency fixed at 8.5 GHz and RF varied

Data Taken as IRM With External IF 90° Hybrid, IF = 3300 MHz

**Conversion Gain, LSB vs. Temperature**

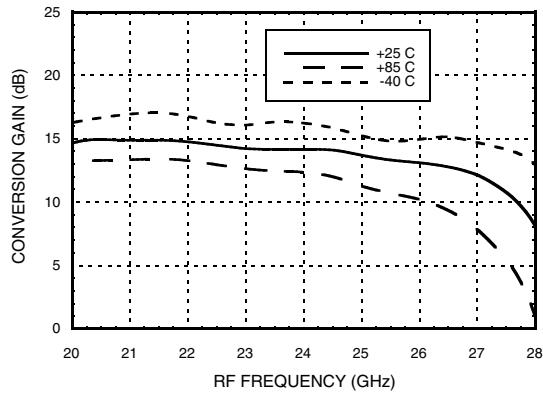

**Conversion Gain, LSB vs. LO Drive**

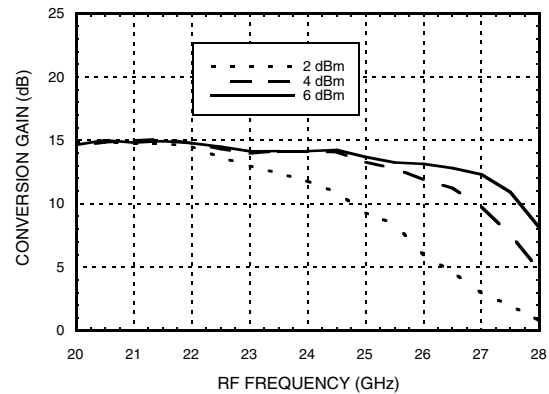

**Image Rejection vs. Temperature**

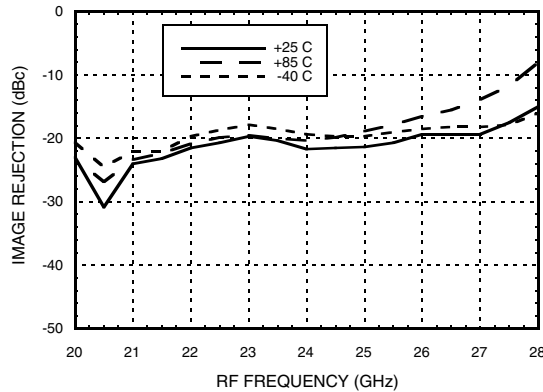

**Input IP3, LSB vs. Temperature**

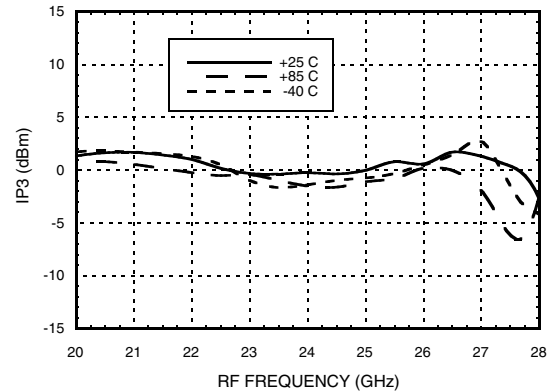

**Input IP3, LSB vs. LO Drive**

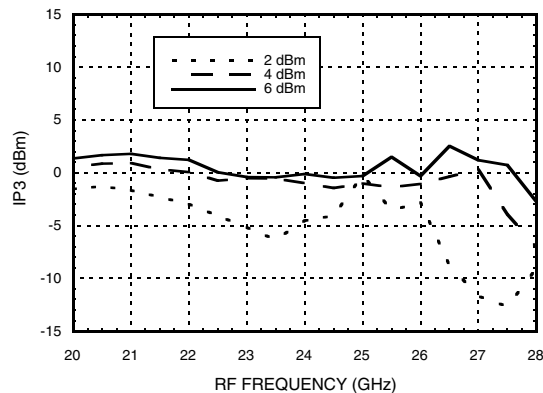

**MxN Spurious Outputs**

mRF	nLO				
	0	1	2	3	4
0	X	-24.8	-11.5	-32.5	X
1	0	-29.0	0	-30.5	X
2	X	-70.8	-48.2	-85	X
3	X	X	X	X	X
4	X	X	X	X	X

RF = 24 GHz @ -20 dBm  
 LO = 11.5 GHz @ +4 dBm  
 Data taken without IF hybrid  
 All values in dBc below IF power level (1RF -2LO = 1 GHz)

**Absolute Maximum Ratings**

RF	+2 dBm
LO Drive	+10 dBm
Vdd	5.0V
Channel Temperature	175 °C
Continuous P <sub>diss</sub> (T=85°C) (derate 17.7 mW/°C above 85°C)	1.6 W
Thermal Resistance (R <sub>TH</sub> ) (channel to package bottom)	56.3 °C/W
Storage Temperature	-65 to +150 °C
Operating Temperature	-40 to +85 °C
ESD Sensitivity (HBM)	Class 1A Pass 250V

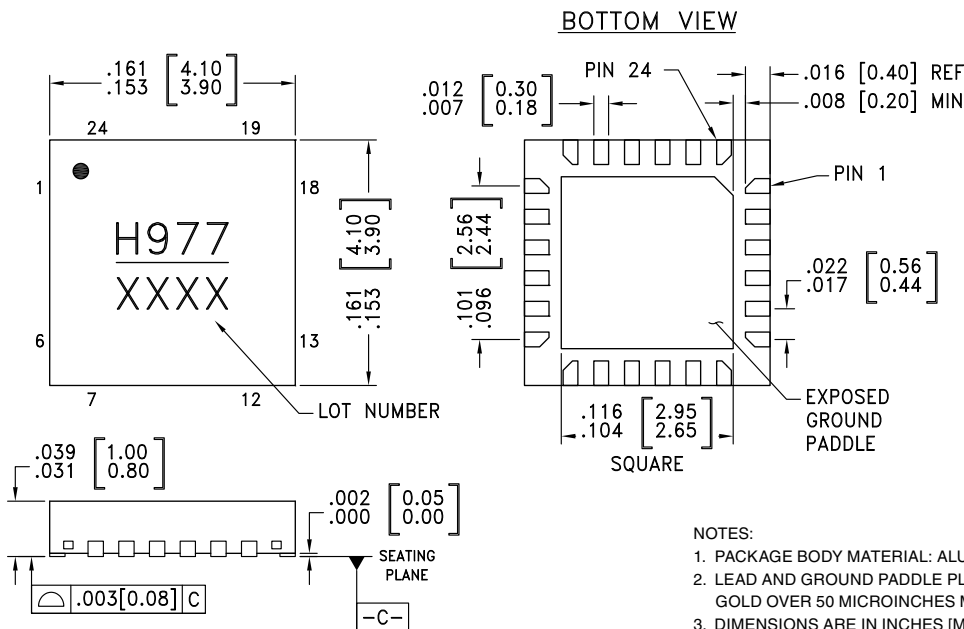

**ELECTROSTATIC SENSITIVE DEVICE  
OBSERVE HANDLING PRECAUTIONS**

**Outline Drawing**

**NOTES:**

1. PACKAGE BODY MATERIAL: ALUMINA
2. LEAD AND GROUND PADDLE PLATING: 30 - 80 MICROINCHES GOLD OVER 50 MICROINCHES MINIMUM NICKLE
3. DIMENSIONS ARE IN INCHES [MILLIMETERS]
4. LEAD SPACING TOLERANCE IS NON-CUMULATIVE
5. PACKAGE WARP SHALL NOT EXCEED 0.05 mm DATUM
6. ALL GROUND LEADS AND GROUND PADDLE MUST BE SOLDERED TO PCB RF GROUND

**Package Information**

Part Number	Package Body Material	Lead Finish	MSL Rating	Package Marking <sup>[1]</sup>
HMC977LP4E	RoHS-Compliant Low Stress Injection Molded Plastic	100% Matte Sn	MSL1 <sup>[2]</sup>	H977 XXXX

[1] 4-Digit lot number XXXX

[2] Max peak reflow temperature of 260 °C

### Pin Descriptions

Pin Number	Function	Description	Interface Schematic
1, 2, 6, 7, 10 - 12, 15, 18 - 22	N/C	The pins are not connected internally; however, all data shown herein was measured with these pins connected to RF/DC ground externally.	
3	VDRF	Power supply for RF LNA.	
4	VDLO2	Power supply for second stage of LO amplifier.	
5	VDLO1	Power supply for first stage of LO amplifier.	
8	LO	This pin is AC coupled and matched to 50 Ohms.	
9, 13, 17, 24	GND	These pins and the exposed ground paddle must be connected to RF/DC ground.	
16	IF2	This pin is DC coupled. For applications not requiring operation to DC this port should be DC blocked externally using a series capacitor whose value has been chosen to pass the necessary frequency range. For operation to DC, this pin must not sink / source more than 3 mA of current or part non-function and possible failure will result.	
14	IF1		
23	RF	This pin is AC coupled and matched to 50 Ohms	

### Typical Application Circuit

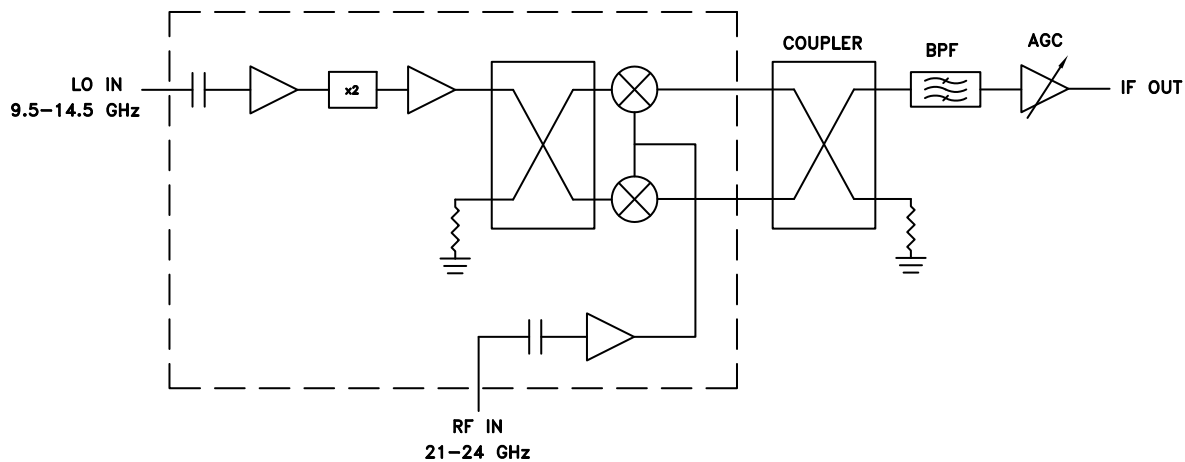

### Evaluation PCB

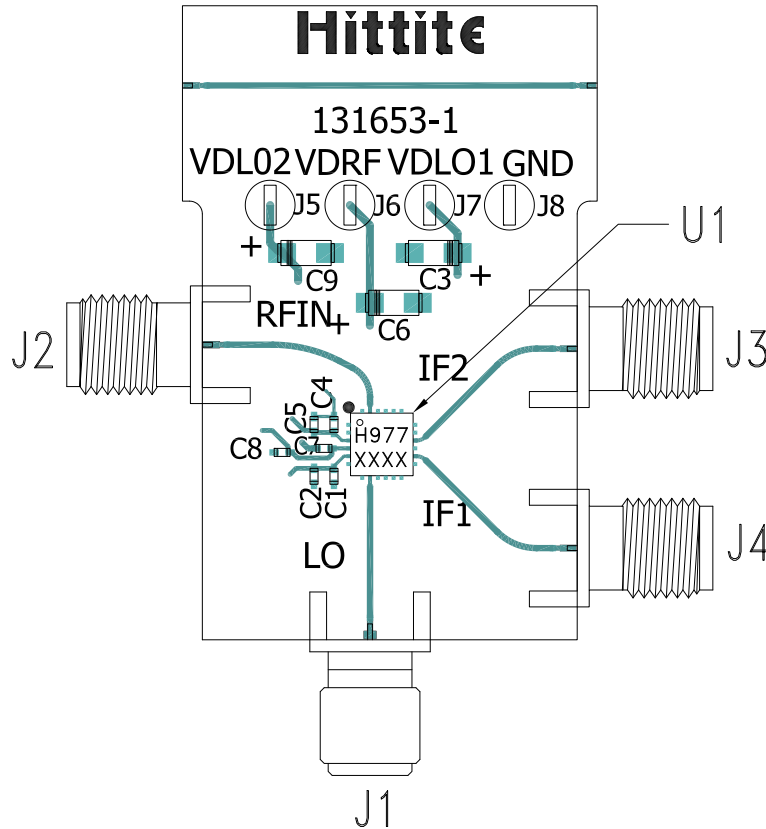

### List of Materials for Evaluation PCB 131656 [1]

Item	Description
J1	PCB Mount SMA RF Connector, SRI
J2, J3	PCB Mount K Connector, SRI
J5 - J8	DC Pin
C1, C4, C7	100 pF Capacitor, 0402 Pkg.
C2, C5, C8	10 nF Capacitor, 0402 Pkg.
C3, C6, C9	4.7 μF Capacitor, Case A Pkg.
U1	HMC977LP4E
PCB [2]	131653 Evaluation Board

[1] Reference this number when ordering complete evaluation PCB

[2] Circuit Board Material: Rogers 4350

The circuit board used in the application should use RF circuit design techniques. Signal lines should have 50 Ohm impedance while the package ground leads and exposed paddle should be connected directly to the ground plane similar to that shown. A sufficient number of via holes should be used to connect the top and bottom ground planes. The evaluation circuit board shown is available from Hittite upon request.