

FEATURES

- Low Cost Integrated Amplifier with Step Attenuator
- Attenuation Range: 0-58 dB, adjustable in 1 dB increments via a 3 wire serial control
- Meets DOCSIS distortion requirements at +60 dBmV output signal level
- Low distortion and low noise
- Frequency range: 5-100 MHz
- 5 Volt operation
- -40 to +85 °C temperature range
- RoHS Compliant Package Option

APPLICATIONS

- MCNS/DOCSIS Compliant Cable Modems
- CATV Interactive Set-Top Box
- Telephony over Cable Systems
- OpenCable Set-Top Box
- Residential Gateway

PRODUCT DESCRIPTION

The ARA2004 is designed to provide the reverse path amplification and output level control functions in a CATV Set-Top Box or Cable Modem. It incorporates a digitally controlled precision step attenuator that is preceded by an ultra low noise amplifier stage, and followed by an ultra-linear output driver amplifier. This device uses a balanced circuit design that exceeds the MCNS/DOCSIS requirement for harmonic

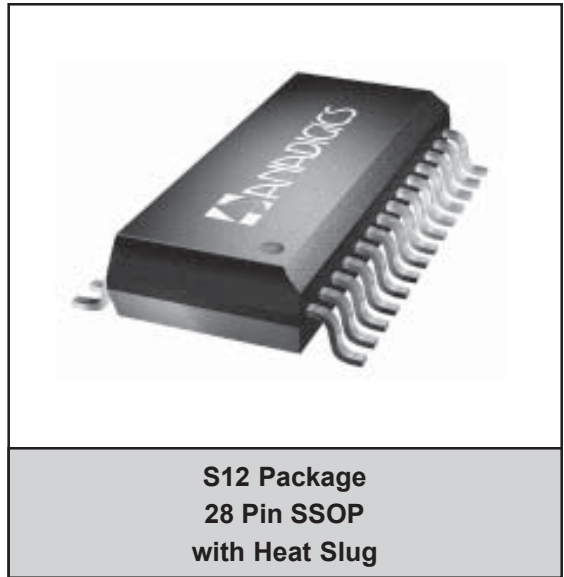

performance at a +60 dBmV output level while only requiring a single polarity +5 V supply. Both the input and output are matched to 75 ohms with an appropriate transformer. The precision attenuator provides up to 58 dB of attenuation in 1 dB increments via a three-wire serial interface. With external passive components, this device meets IEC 1000-4-12 and ANSI/IEEE C62.41-1991 100kHz ringwave tests, as well as IEC1000-4-5 1.2/50 μS surge tests. The ARA2004 is offered in a 28-pin SSOP package featuring a heat slug on the bottom of the package.

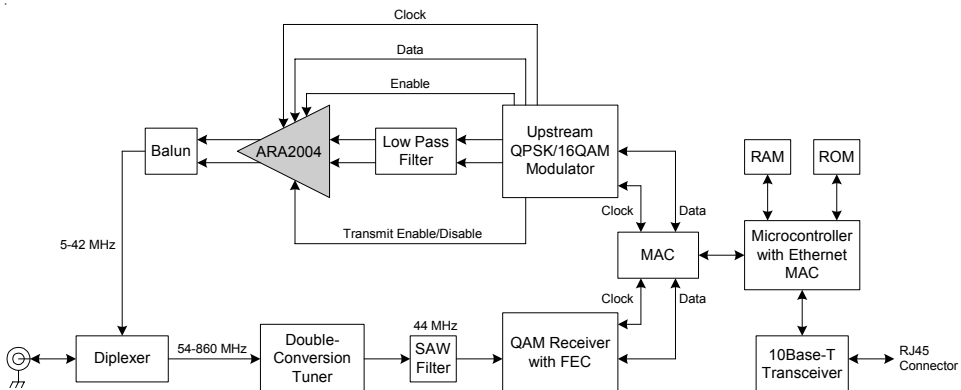

Figure 1: Cable Modem or Set Top Box Application Diagram

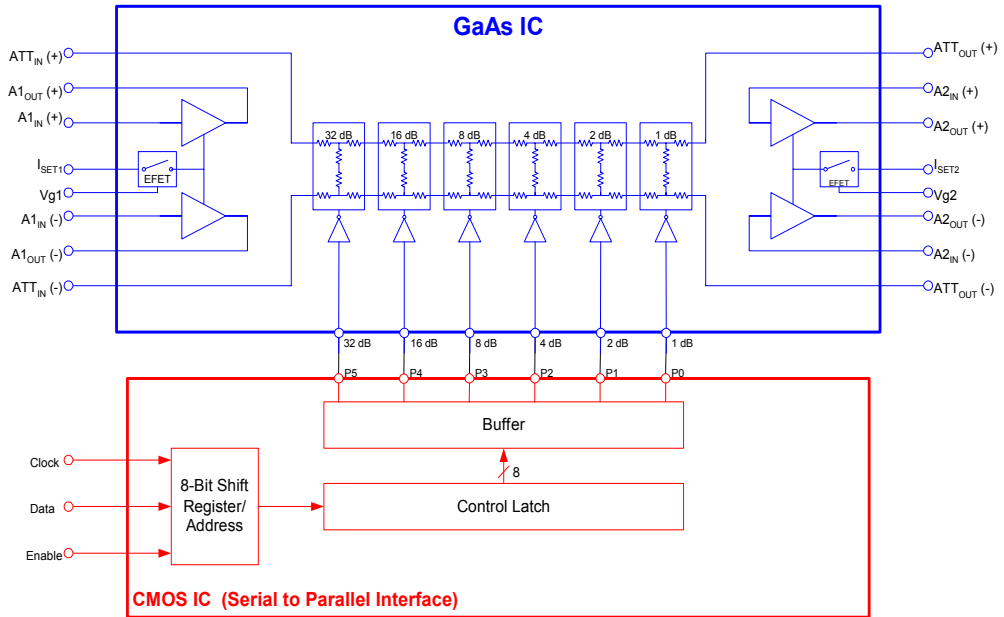

Figure 2: Functional Block Diagram

1	GND	GND	28
2	V _{ATTN}	N/C	27
3	ATT _{IN} (+)	ATT _{OUT} (+)	26
4	A1 _{OUT} (+)	A2 _{IN} (+)	25
5	A1 _{IN} (+)	A2 _{OUT} (+)	24
6	Vg1	Vg2	23
7	I _{SET1}	I _{SET2}	22
8	A1 _{IN} (-)	A2 _{OUT} (-)	21
9	A1 _{OUT} (-)	A2 _{IN} (-)	20
10	ATT _{IN} (-)	ATT _{OUT} (-)	19
11	V _{CMOS}	GND _{CMOS}	18
12	CLK	N/C	17
13	DAT	N/C	16
14	En	N/C	15

Figure 3: Pin Out

Table 1: Pin Description

PIN	NAME	DESCRIPTION	PIN	NAME	DESCRIPTION
1	GND	Ground	15	N/C	No Connection ⁽¹⁾
2	V _{ATTN}	Supply for Attenuator	16	N/C	No Connection ⁽¹⁾
3	ATT _{IN} (+)	Attenuator (+) Input ⁽²⁾	17	N/C	No connection ⁽¹⁾
4	A1 _{OUT} (+)	Amplifier A1 (+) Output	18	GND _{CMOS}	Ground for Digital CMOS Circuit
5	A1 _{IN} (+)	Amplifier A1 (+) Input ⁽²⁾	19	ATT _{OUT} (-)	Attenuator (-) Output ⁽²⁾
6	Vg1	Amplifier A1 (+/-) Control	20	A2 _{IN} (-)	Amplifier A2 (-) Input ⁽²⁾
7	I _{SET1}	Amplifier A1 (+/-) Current Adjust	21	A2 _{OUT} (-)	Amplifier A2 (-) Output
8	A1 _{IN} (-)	Amplifier A1 (-) Input ⁽²⁾	22	I _{SET2}	Amplifier A2 (+/-) Current Adjust
9	A1 _{OUT} (-)	Amplifier A1 (-) Output	23	Vg2	Amplifier A2 (+/-) Control
10	ATT _{IN} (-)	Attenuator (-) Input ⁽²⁾	24	A2 _{OUT} (+)	Amplifier A2 (+) Output
11	V _{CMOS}	Supply For Digital CMOS Circuit	25	A2 _{IN} (+)	Amplifier A2 (+) Input ⁽²⁾
12	CLK	Clock	26	ATT _{OUT} (+)	Attenuator (+) Output ⁽²⁾
13	DAT	Data	27	N/C	No Connection ⁽¹⁾
14	En	Enable	28	GND	Ground

Notes:

(1) All N/C pins should be grounded.

(2) Pins should be AC-coupled. No external DC bias should be applied.

ELECTRICAL CHARACTERISTICS

Table 2: Absolute Minimum and Maximum Ratings

PARAMETER	MIN	MAX	UNIT
Analog Supply (pins 2, 4, 9, 21, 24)	0	9	VDC
Digital Supply: V _{CMOS} (pin 11)	0	6	VDC
Amplifier Controls Vg1, Vg2 (pins 6, 23)	-5	2	V
RF Power at Inputs (pins 5, 8)	-	+60	dBmV
Digital Interface (pins 12, 13, 14)	-0.5	V _{CMOS} +0.5	V
Storage Temperature	-55	+200	°C
Soldering Temperature	-	260	°C
Soldering Time	-	5	Sec

Stresses in excess of the absolute ratings may cause permanent damage. Functional operation is not implied under these conditions. Exposure to absolute ratings for extended periods of time may adversely affect reliability.

Notes:

1. Pins 3, 5, 8, 10, 19, 20, 25 and 26 should be AC-coupled. No external DC bias should be applied.
2. Pins 7 and 22 should be grounded or pulled to ground through a resistor. No external DC bias should be applied.

Table 3: Operating Ranges

PARAMETER	MIN	TYP	MAX	UNIT
Amplifier Supply: V _{DD} (pins 4, 9, 21, 24)	4.5	5	7	VDC
Attenuator Supply: V _{ATTN} (pin 2)	V _{DD} -0.5	5	7	VDC
Digital Supply: V _{CMOS} (pin 11)	3.0	-	5.5	VDC
Digital Interface	0	-	V _{CMOS}	V
Amplifier Controls Vg1, Vg2 (pins 6, 23)	-5	1	2	V
Case Temperature	-40	25	85	°C

The device may be operated safely over these conditions; however, parametric performance is guaranteed only over the conditions defined in the electrical specifications.

Table 4: DC Electrical Specifications**T_A=25°C; V_{DD}, V_{ATTN}, V_{CMOS} = +5.0 VDC; Vg1, Vg2 = +1.0 V (Tx enabled); Vg1, Vg2 = 0 V (Tx disabled)**

PARAMETER	MIN	TYP	MAX	UNIT	COMMENTS
Amplifier A1 Current (pins 4, 9)	- -	48 2.4	80 6	mA	Tx enabled Tx disabled
Amplifier A2 Current (pins 21, 24)	- -	77 3.7	120 9	mA	Tx enabled Tx disabled
Attenuator Current (pin 2)	-	9	15	mA	
Total Power Consumption	- -	0.67 75	1.08 150	W mW	Tx enabled Tx disabled

Table 5: AC Electrical Specifications**T_A=25°C; V_{DD}, V_{ATTN}, V_{CMOS} = +5.0 VDC; Vg1, Vg2 = +1.0 V (Tx enabled); Vg1, Vg2 = 0 V (Tx disabled)**

PARAMETER	MIN	TYP	MAX	UNIT	COMMENTS
Gain (10 MHz)	27.5	29.3	30.5	dB	0 dB attenuation setting
Gain Flatness	- -	0.75 1.5	- -	dB	5 to 42 MHz 5 to 65 MHz
Gain Variation over Temperature	-	-0.006	-	dB/°C	
Attenuation Steps					
1 dB	0.65	0.83	1.00	dB	Monotonic
2 dB	1.6	1.70	2.05		
4 dB	3.6	3.75	4.0		
8 dB	7.5	7.75	8.0		
16 dB	15.0	15.40	15.8		
32 dB	30.2	30.75	31.3		
Maximum Attenuation	58.6	60.3	-	dB	
2 nd Harmonic Distortion Level (10 MHz)	-	-75	-53	dBc	+60 dBmV into 75 Ohms
3 rd Harmonic Distortion Level (10 MHz)	-	-60	-53	dBc	+60 dBmV into 75 Ohms
3 rd Order Output Intercept	78	-	-	dBmV	
1 dB Gain Compression Point	-	68.5	-	dBmV	
Noise Figure	-	3.0	4.0	dB	Includes input balun loss

Note: As measured in ANADIGICS test fixture

continued: AC Electrical Specifications

$T_A=25^{\circ}\text{C}$; V_{DD} , V_{ATTN} , $V_{CMOS} = +5.0\text{ VDC}$; V_{g1} , $V_{g2} = +1.0\text{ V}$ (Tx enabled); V_{g1} , $V_{g2} = 0\text{ V}$ (Tx disabled)

PARAMETER	MIN	TYP	MAX	UNIT	COMMENTS
Output Noise Power Active / No Signal / Min. Atten. Set. Active / No Signal / Max. Atten. Set.	- -	- -	-38.5 -53.8	dBmV	Any 160 kHz bandwidth from 5 to 42 MHz
Isolation (45 MHz) in Tx disable mode	-	65	-	dB	Difference in output signal between Tx enable and Tx disable
Differential Input Impedance	-	300	-	Ohms	between pins 5 and 8 (Tx enabled)
Input Impedance	-	75	-	Ohms	with transformer (Tx enabled)
Input Return Loss (75 Ohm characteristic impedance)	- -	-20 -5	-12 -	dB	Tx enabled Tx disabled
Differential Output Impedance	-	300	-	Ohms	between pins 21 and 24
Output Impedance	-	75	-	Ohms	with transformer
Output Return Loss (75 Ohm characteristic impedance)	- -	-17 -15	-12 -10	dB	Tx enabled Tx disabled
Output Voltage Transient Tx enable / Tx disable	- -	- 4	100 7	mVp-p	0 dB attenuator setting 24 dB attenuator setting

Note: As measured in ANADIGICS test fixture

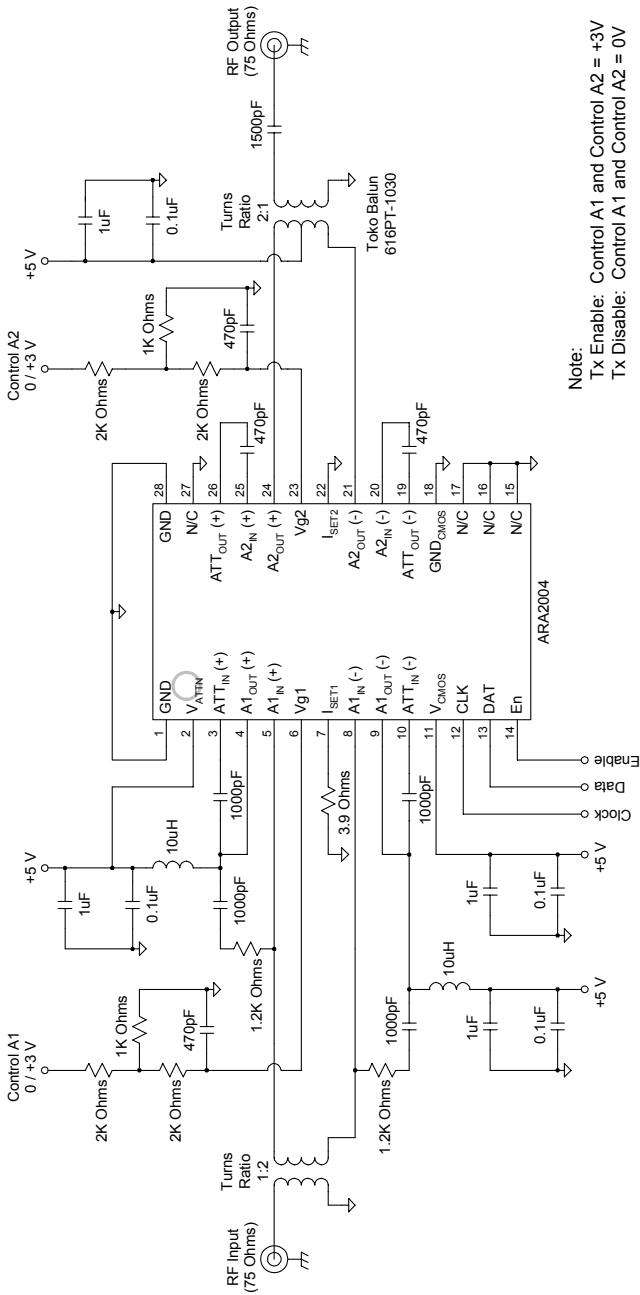

Note:
 Tx Enable: Control A1 and Control A2 = +3V
 Tx Disable: Control A1 and Control A2 = 0V

Figure 4: Test Circuit

PERFORMANCE DATA

Figure 5: Attenuation Level vs Control Word

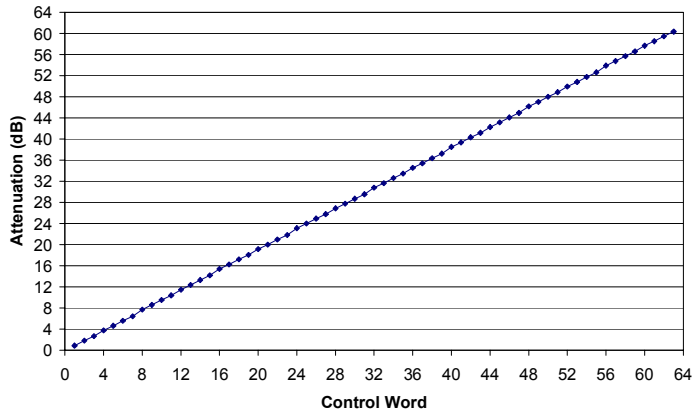

Figure 6: Gain & Noise Figure vs Frequency

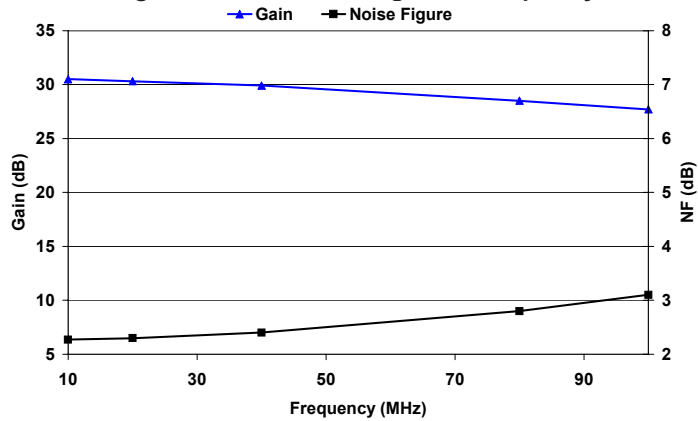

Figure 7: Gain & Noise Figure vs V_{DD}

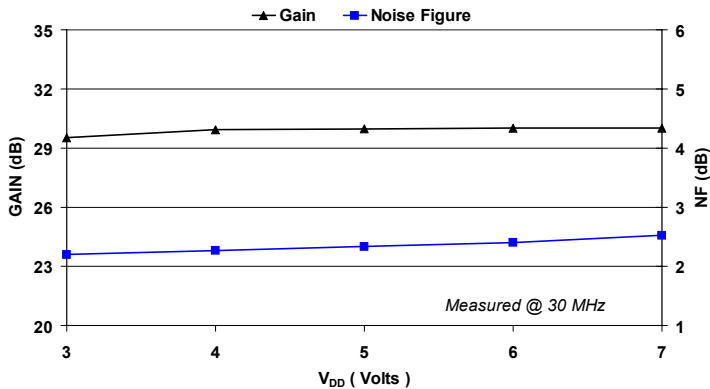

Figure 8: Gain & Noise Figure vs Temperature

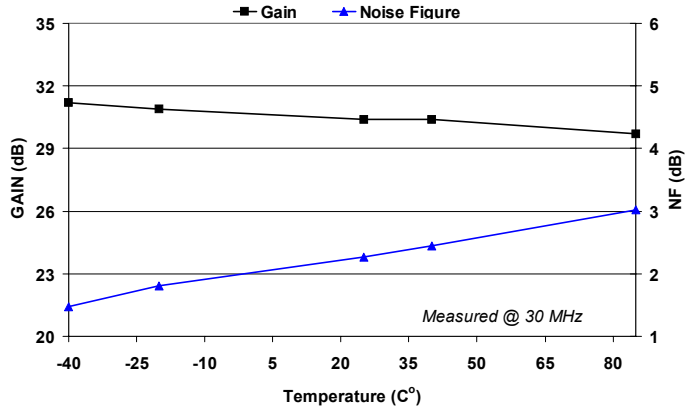

Figure 9: Harmonic Distortion vs V_{DD}

P_{OUT} = 58dBmV

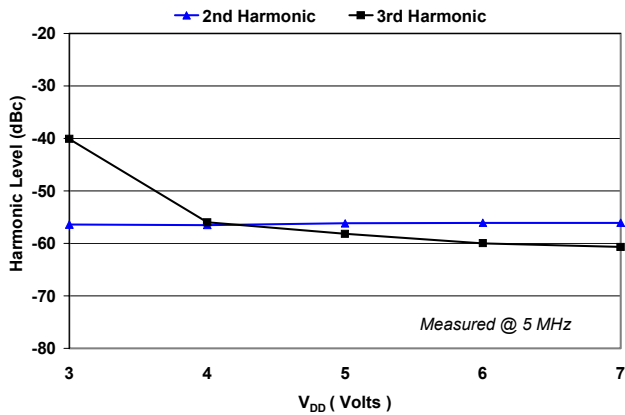

Figure 10: Harmonic Distortion vs V_{DD}

P_{OUT} = 58dBmV

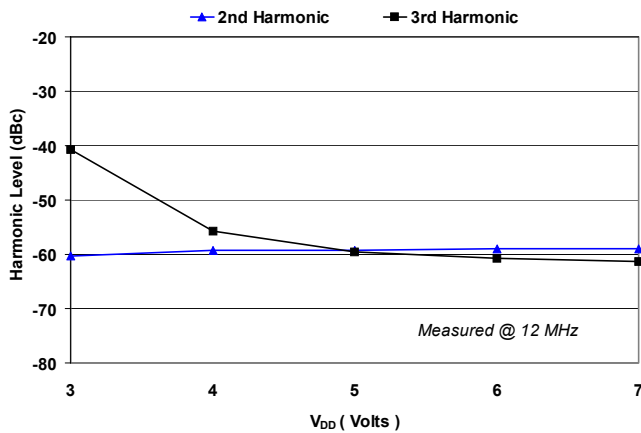

Figure 11: Harmonic Distortion vs Temperature
 P_{OUT} = 58dBmV

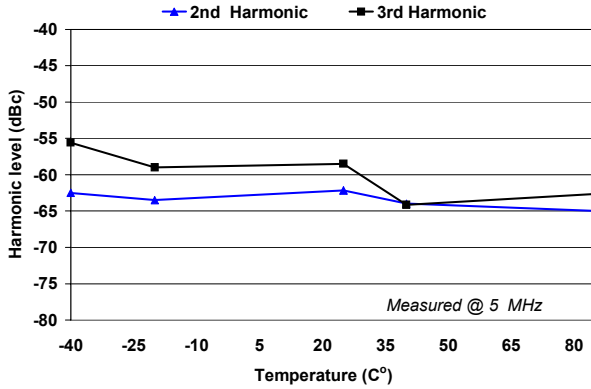

Figure 12: Harmonic Distortion vs Power Out

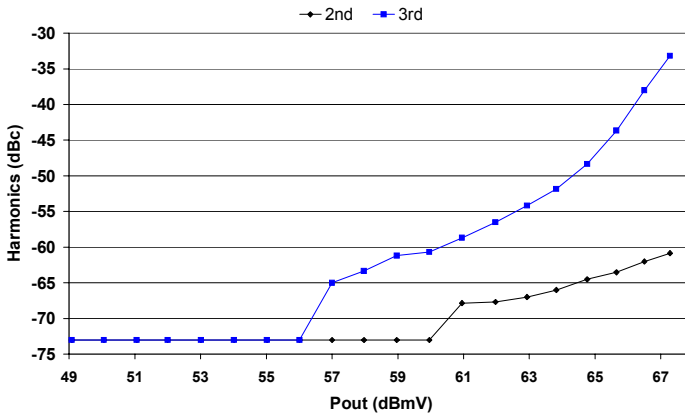

Figure 13: Transients vs Attenuation
 P_{OUT} = 55dBmV at 0dB attenuation

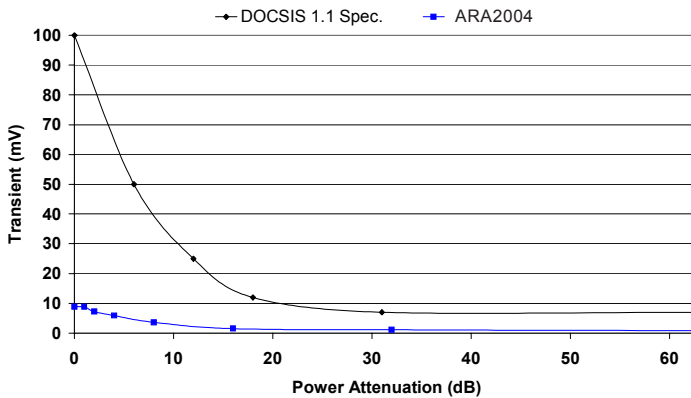

Figure 14: Harmonic Performance over Frequency $P_{OUT} = +62\text{dBmV}$

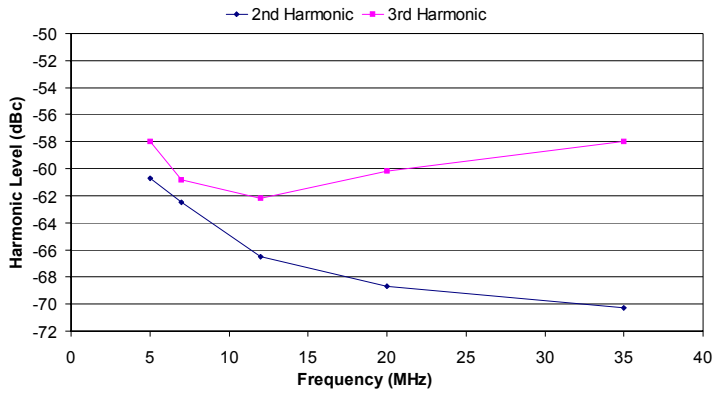

Figure 15: IIP₂ & IIP₃ vs Frequency

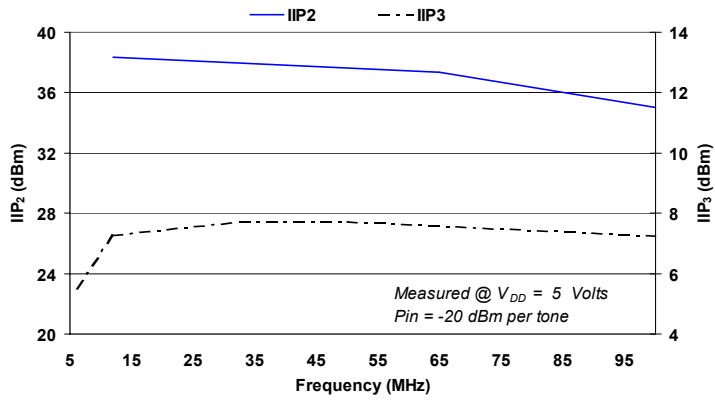
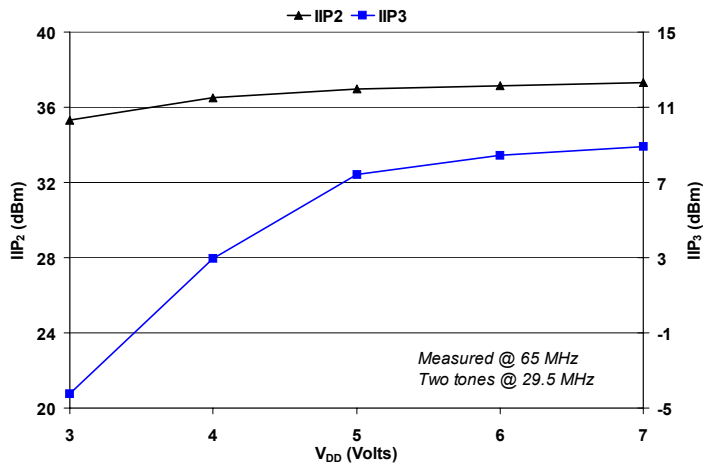

Figure 16: IIP₂ & IIP₃ vs V_{DD}



LOGIC PROGRAMMING

Programming Instructions

The programming word is set through an 8 bit shift register via the data, clock and enable lines. The data is entered in order with the most significant bit (MSB) first and the least significant bit (LSB) last.

The enable line must be low for the duration of the data entry, then set high to latch the shift register. The rising edge of the clock pulse shifts each data value into the register.

Table 6: Programming Word

DATA BIT	D ₇	D ₆	D ₅	D ₄	D ₃	D ₂	D ₁	D ₀
Value	P7	P6	P5	P4	P3	P2	P1	P0

Table 7: Data Description

VALUE	FUNCTION (1 = on, 0 = bypass)
P7	N/A
P6	N/A
P5	32 dB Attenuator Bit
P4	16 dB Attenuator Bit
P3	8 dB Attenuator Bit
P2	4 dB Attenuator Bit
P1	2 dB Attenuator Bit
P0	1 dB Attenuator Bit

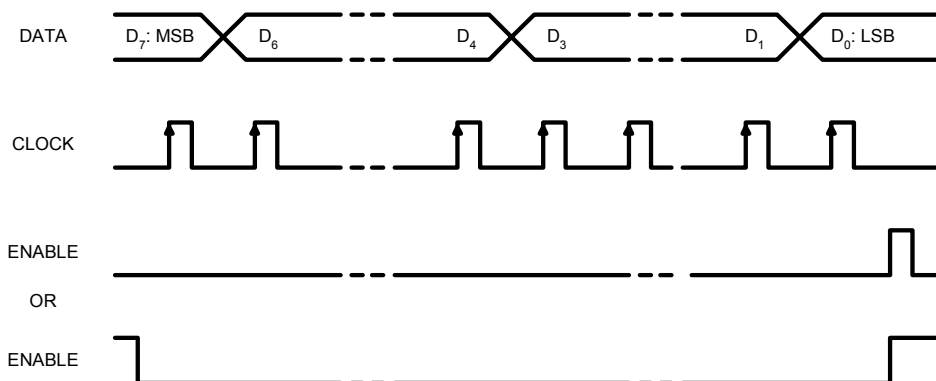

Figure 17: Serial Data Input Timing

APPLICATION INFORMATION

Transmit Enable / Disable

The ARA2004 includes two amplification stages that each can be shut down through external control pins Vg1 and Vg2 (pins 6 and 23, respectively.) By applying a slightly positive bias of typically +1.0 Volts, the amplifier is enabled. In order to disable the amplifier, the control pin needs to be pulled to ground.

A practical way to implement the necessary control is to use bias resistor networks similar to those shown in the test circuit schematic (Figure 4.) Each network includes a resistor shunted to ground that serves as a pull-down to disable the amplifier when no control voltage is applied. When a positive voltage is applied, the network acts as a voltage divider that presents the required +1.0 Volts to enable the amplifier. By selecting different resistor values for the voltage divider, the network can accommodate different control voltage inputs.

The Vg1 and Vg2 pins may be connected together directly, and controlled through a single resistor network from a common control voltage.

Amplifier Bias Current

The ISET pins (7 and 22) set the bias current for the amplification stages. Grounding these pins results in the maximum possible current. By placing a resistor from the pin to ground, the current can be reduced. The recommended bias conditions use the configuration shown in the test circuit schematic in Figure 4.

Thermal Layout Considerations

The device package for the ARA2004 features a heat slug on the bottom of the package body. Use of the heat slug is an integral part of the device design. Soldering this slug to the ground plane of the PC board will ensure the lowest possible thermal resistance for the device, and will result in the longest MTF (mean time to failure.)

A PC board layout that optimizes the benefits of the heat slug is shown in Figure 18. The via holes located under the body of the device must be plated through to a ground plane layer of metal, in order to provide a sufficient heat sink. The recommended solder mask outline is shown in Figure 19.

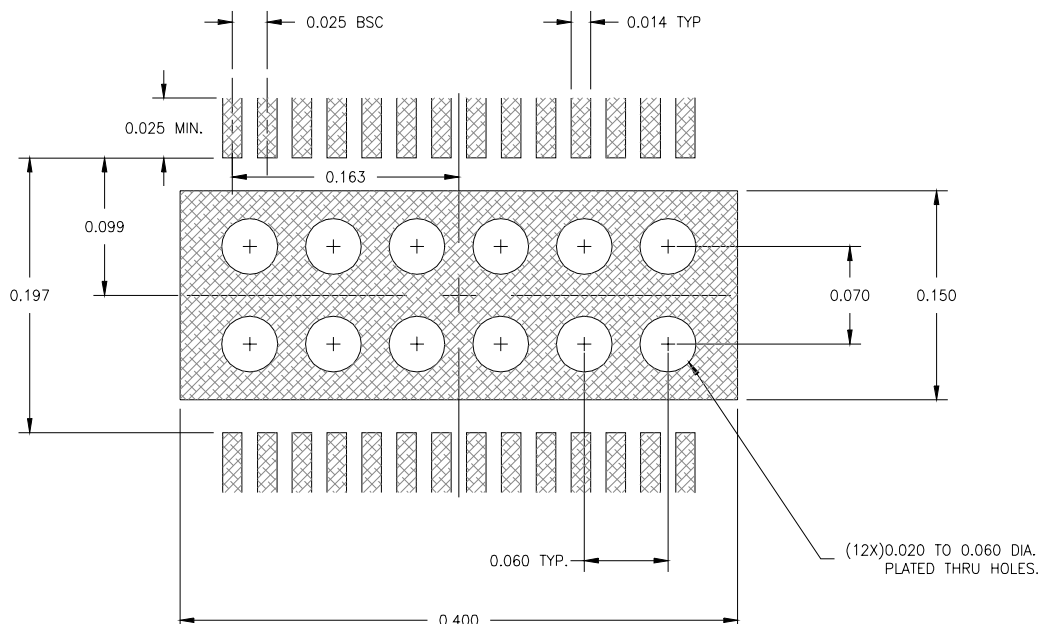

Figure 18: PC Board Layout

Output Transformer

Matching the output of the ARA2004 to a 75 Ohm load is accomplished using a 2:1 turns ratio transformer. In addition to providing an impedance transformation, this transformer provides the bias to the output amplifier stage via the center tap.

The transformer also cancels even mode distortion products and common mode signals, such as the voltage transients that occur while enabling and disabling the amplifiers. As a result, care must be taken when selecting the transformer to be used at the output. It must be capable of handling the RF and DC power requirements without saturating the core, and it must have adequate isolation and good

phase and amplitude balance. It also must operate over the desired frequency and temperature range for the intended application.

ESD Sensitivity

Electrostatic discharges can cause permanent damage to this device. Electrostatic charges accumulate on test equipment and the human body, and can discharge without detection. Although the ARA2004 has some built-in ESD protection, proper precautions and handling are strongly recommended. Refer to the ANADIGICS application note on ESD precautions.

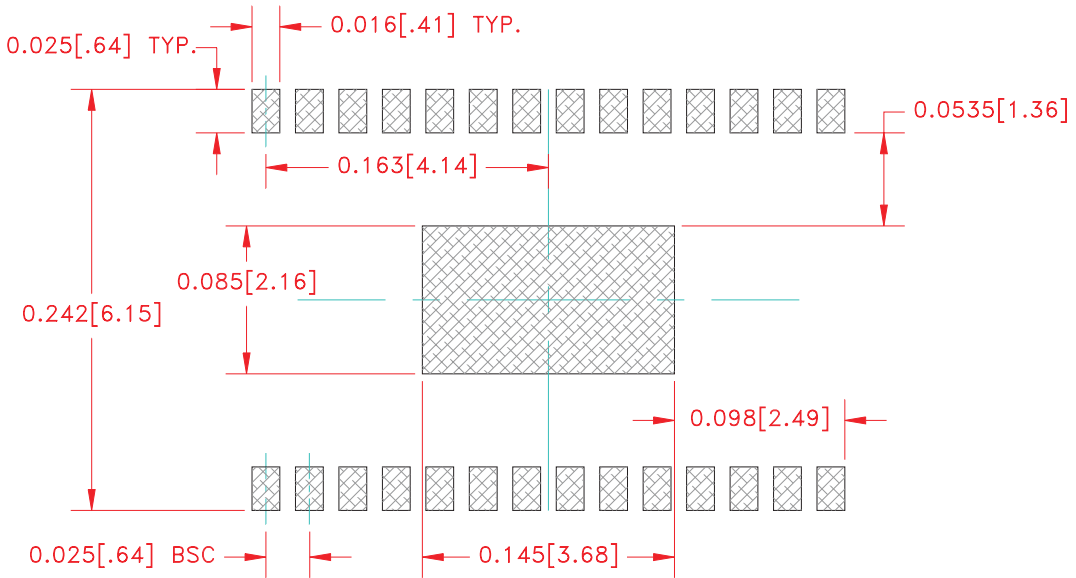
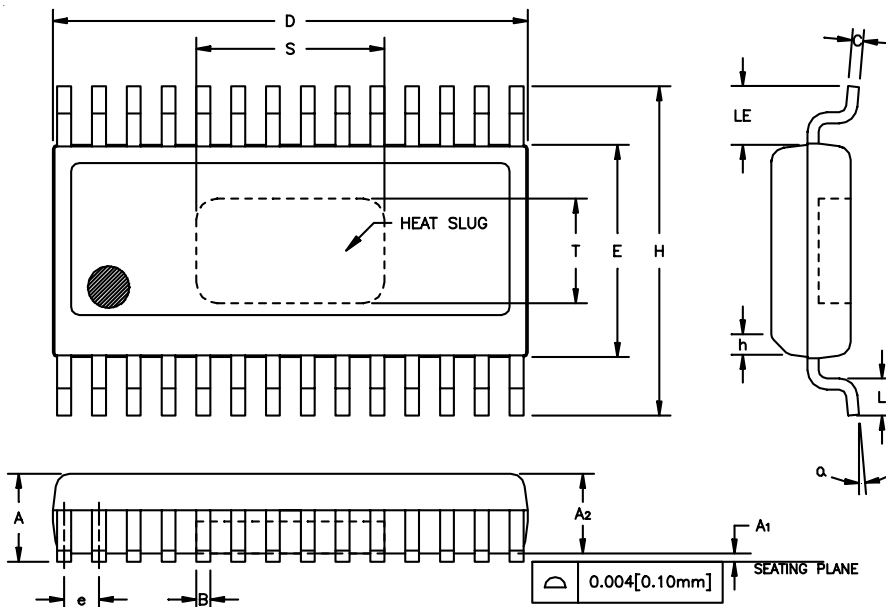

Figure 19: Solder Mask Outline

PACKAGE OUTLINE



SYMBOL	INCHES		MILLIMETERS		NOTE
	MIN.	MAX.	MIN.	MAX.	
A	0.058	0.068	1.47	1.73	
A ₁	0.000	0.004	0.00	0.10	
A ₂	0.054	0.060	1.37	1.52	
B	0.008	0.014	0.20	0.35	5
C	0.007	0.012	0.18	0.30	5
D	0.385	0.393	9.78	9.98	2
E	0.151	0.157	3.84	3.99	3
e	0.025	BSC	0.64	BSC	4
H	0.228	0.244	5.79	6.20	
h	0.015x45°		0.38x45°		
L	0.016	0.032	0.41	0.81	
LE	0.042	—	1.07	—	
α	0°	8°	0°	8°	
S	0.105	0.135	2.67	3.43	6
T	0.045	0.075	1.41	1.91	6

NOTES:

1. CONTROLLING DIMENSION: INCHES
2. DIMENSION "D" DOES NOT INCLUDE MOLD FLASH, PROTRUSIONS OR GATE BURRS. MOLD FLASH, PROTRUSIONS AND GATE BURRS SHALL NOT EXCEED 0.006 [0.15mm] PER SIDE.
3. DIMENSION "E" DOES NOT INCLUDE INTER-LEAD FLASH OR PROTRUSIONS. INTER-LEAD FLASH AND PROTRUSIONS SHALL NOT EXCEED 0.010 [0.25mm] PER SIDE.
4. MAXIMUM LEAD TWIST/SKEW TO BE ±0.0035 [0.089mm].
5. LEAD WIDTH "B" AND THICKNESS "C" MAX. DIMENSION IS AFTER PLATING.
6. DIMENSIONS "S" AND "T" INDICATE EXPOSED SLUG AREA.

0-012

Figure 20: S12 Package Outline - 28 Pin SSOP with Heat Slug

COMPONENT PACKAGING

Volume quantities of the ARA2004 are supplied on tape and reel. Each reel holds 3,500 pieces.

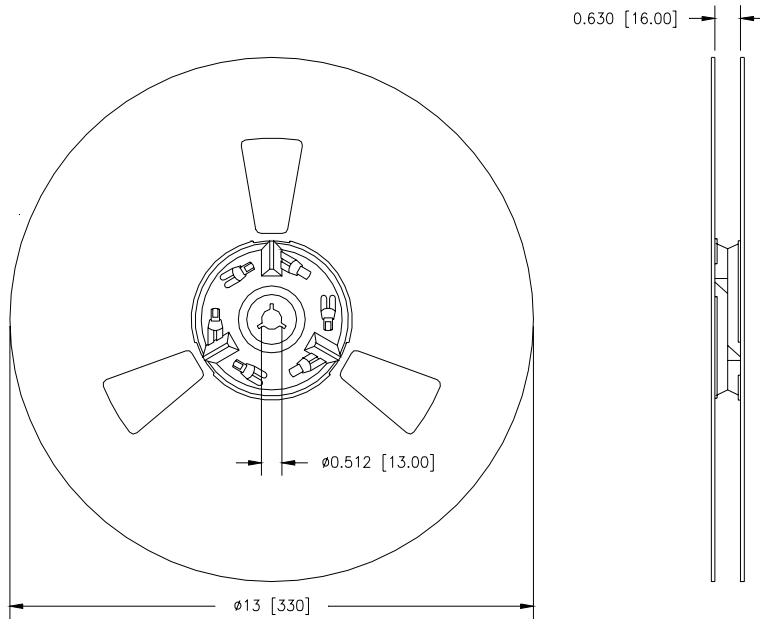

Figure 21: Reel Dimensions

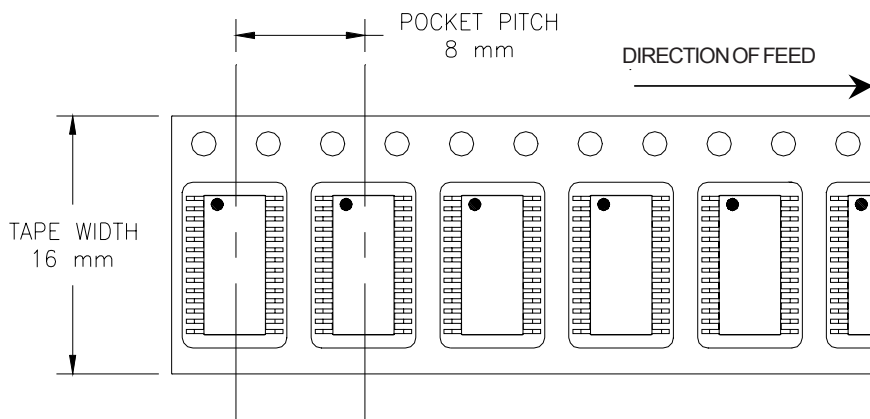

Figure 22: Tape Dimensions

NOTES

NOTES

ORDERING INFORMATION

ORDER NUMBER	TEMPERATURE RANGE	PACKAGE DESCRIPTION	COMPONENT PACKAGING
ARA2004S12P1	-40 to 85 °C	28 Pin SSOP with Heat Slug	3,500 piece tape and reel
ARA2004RS12P1	-40 to 85 °C	RoHS Compliant 28 Pin SSOP with Heat Slug	3,500 piece tape and reel

**ANADIGICS, Inc.**

141 Mount Bethel Road
Warren, New Jersey 07059, U.S.A.

Tel: +1 (908) 668-5000

Fax: +1 (908) 668-5132

URL: <http://www.anadigics.com>

E-mail: Mktg@anadigics.com

IMPORTANT NOTICE

ANADIGICS, Inc. reserves the right to make changes to its products or to discontinue any product at any time without notice. The product specifications contained in Advanced Product Information sheets and Preliminary Data Sheets are subject to change prior to a product's formal introduction. Information in Data Sheets have been carefully checked and are assumed to be reliable; however, ANADIGICS assumes no responsibilities for inaccuracies. ANADIGICS strongly urges customers to verify that the information they are using is current before placing orders.

WARNING

ANADIGICS products are not intended for use in life support appliances, devices or systems. Use of an ANADIGICS product in any such application without written consent is prohibited.