

# 17-21 GHz Medium Power Amplifier TGA9088A-SCC

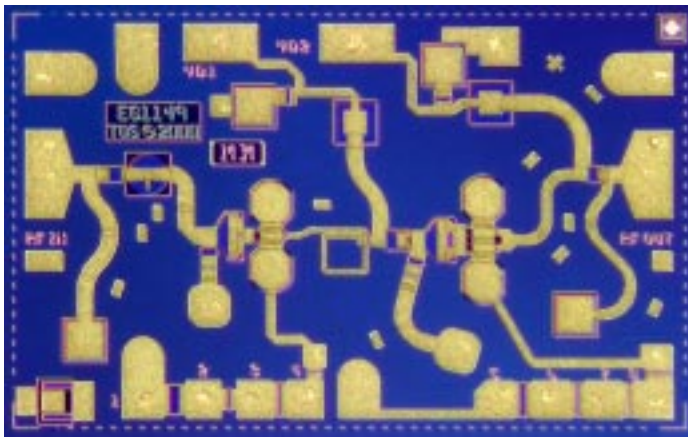

Chip Dimensions 2.4mm x 1.5 mm x 0.1mm

## Key Features and Performance

- 0.25um PHEMT Technology
- 17-21GHz Frequency Range
- 22 dBm @ P2dB Nominal Pout
- 18.5 dB Nominal Gain
- IRL>18 dB, ORL>10 dB
- 7V, 66mA Self Bias

## Primary Applications

- Satellite Systems
- Point-to-Point Radio

## Description

The TriQuint TGA9088A-SCC is a 17-21 GHz 0.125 Watt self-biased Medium Power Amplifier in MMIC form. The part is designed using TriQuint's proven standard 0.25 um gate PHEMT production process with 100 um substrate technology.

This MPA provides a nominal 22 dBm of output power at 2 dB gain compression with a nominal small signal gain of 18.5 dB.

The part provides an economical solution for a 20 GHz driver and provides application solutions for the Satellite and Point-to-Point Radio markets

The TGA9088A-SCC is 100% DC and RF tested on-wafer to ensure performance compliance.

## Typical Electrical Characteristics 7V, 66mA Self Bias

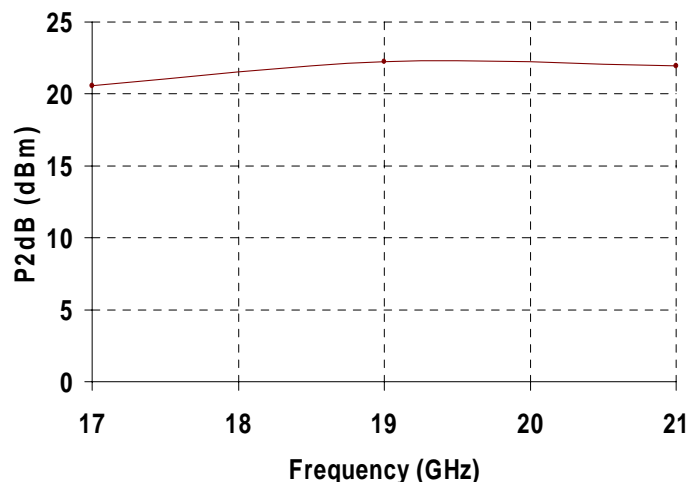
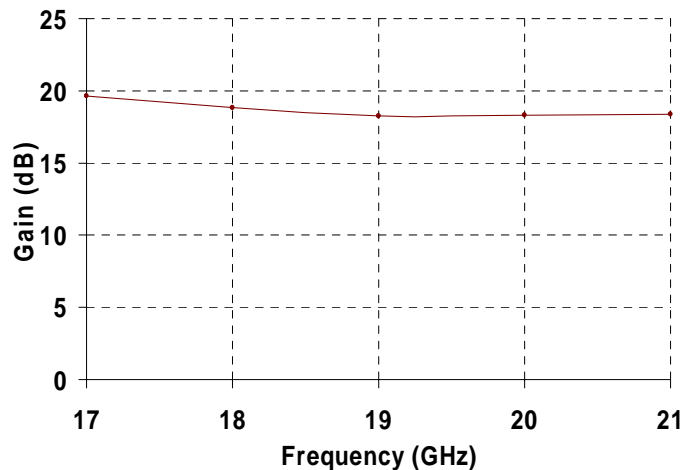

**TABLE I**  
**MAXIMUM RATINGS 6/**

SYMBOL	PARAMETER	VALUE	NOTES
V <sup>+</sup>	Positive Supply Voltage	8 V	4/
I <sup>+</sup>	Positive Supply Current (Quiescent)	90 mA	5/ 4/
I <sub>G</sub>	Gate Supply Current	3.5 mA	
P <sub>IN</sub>	Input Continuous Wave Power	17 dBm	
P <sub>D</sub>	Power Dissipation	0.615 W	3/ 4/
T <sub>CH</sub>	Operating Channel Temperature	150 °C	1/ 2/
T <sub>M</sub>	Mounting Temperature (30 Seconds)	320 °C	
T <sub>STG</sub>	Storage Temperature	-65 to 150 °C	

- 1/ These ratings apply to each individual FET.
- 2/ Junction operating temperature will directly affect the device median time to failure (T<sub>M</sub>). For maximum life, it is recommended that junction temperatures be maintained at the lowest possible levels.
- 3/ When operated at this bias condition with a base plate temperature of 70 °C (T<sub>ch</sub> = 149.27°C), the median life is reduced from 6.9E+6 to 1.1E+6 hrs.
- 4/ Combinations of supply voltage, supply current, input power, and output power shall not exceed P<sub>D</sub>.
- 5/ Total current for the entire MMIC.
- 6/ These ratings represent the maximum operable values for this device.

**TABLE II**  
**DC PROBE TESTS**  
(T<sub>A</sub> = 25 °C Nominal)

SYMBOL	PARAMETER	MINIMUM	MAXIMUM	VALUE
I <sub>max1</sub>	Maximum Current	56	102	mA
G <sub>M1</sub>	Transconductance	33	80	mS
V <sub>P1,2</sub>	Pinch-off Voltage	-1.5	-0.5	V
V <sub>BVGS1</sub>	Breakdown Voltage gate-source	-30	-8	V
V <sub>BVGD1</sub>	Breakdown Voltage gate-drain	-30	-12	V

**TABLE III**  
**ON-WAFER RF PROBE CHARACTERISTICS**

(T<sub>A</sub> = 25 °C Nominal)

Self Bias V<sub>d</sub> = 7 V

SYMBOL	PARAMETER	TEST CONDITION 45mA ≤ I <sub>d</sub> ≤ 80mA	LIMIT			UNITS
			MIN	TYP	MAX	
Gain	Small Signal Gain	F = 17 – 21 GHz*	16	18.5	---	dB
IRL	Input Return Loss	F = 17 – 21 GHz*	---	-15	-7	dB
ORL	Output Return Loss	F = 17 – 21 GHz*	---	-13	-6	dB
P2dB	Output Power @ 2dB Compression	F = 17 GHz**	17	19	---	dBm
		F = 19 - 21 GHz**	20	22	---	

\* S-parameter data is taken at 1GHz step size.

\*\* Power data is taken at 2 GHz step size.

**TABLE IV**  
**THERMAL INFORMATION\***

PARAMETER	TEST CONDITIONS	T <sub>CH</sub> (°C)	R <sub>θJC</sub> (°C/W)	T <sub>M</sub> (HRS)
R <sub>θJC</sub> Thermal Resistance (channel to backside of carrier)	V <sub>d</sub> = 7 V I <sub>D</sub> = 66 mA Self Bias P <sub>diss</sub> = 0.462 W	128.35	126.30	6.9E+6

Note: Assumes eutectic attach using 1.5 mil 80/20 AuSn Solder mounted to a 20 mil CuMo Carrier at 70°C baseplate temperature. Worst case condition with no RF applied, 100% of DC power is dissipated.

\* This information is a result of a thermal model.

**Typical On-Wafer Electrical Characteristics**

7V, 66mA Self Bias

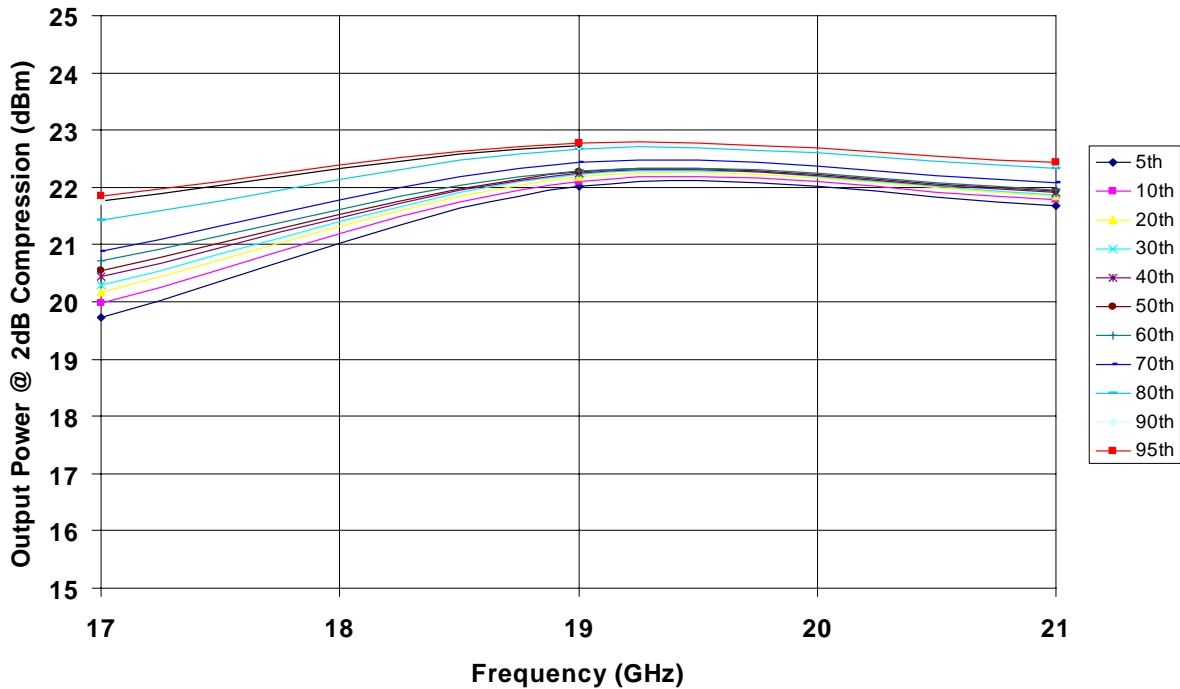
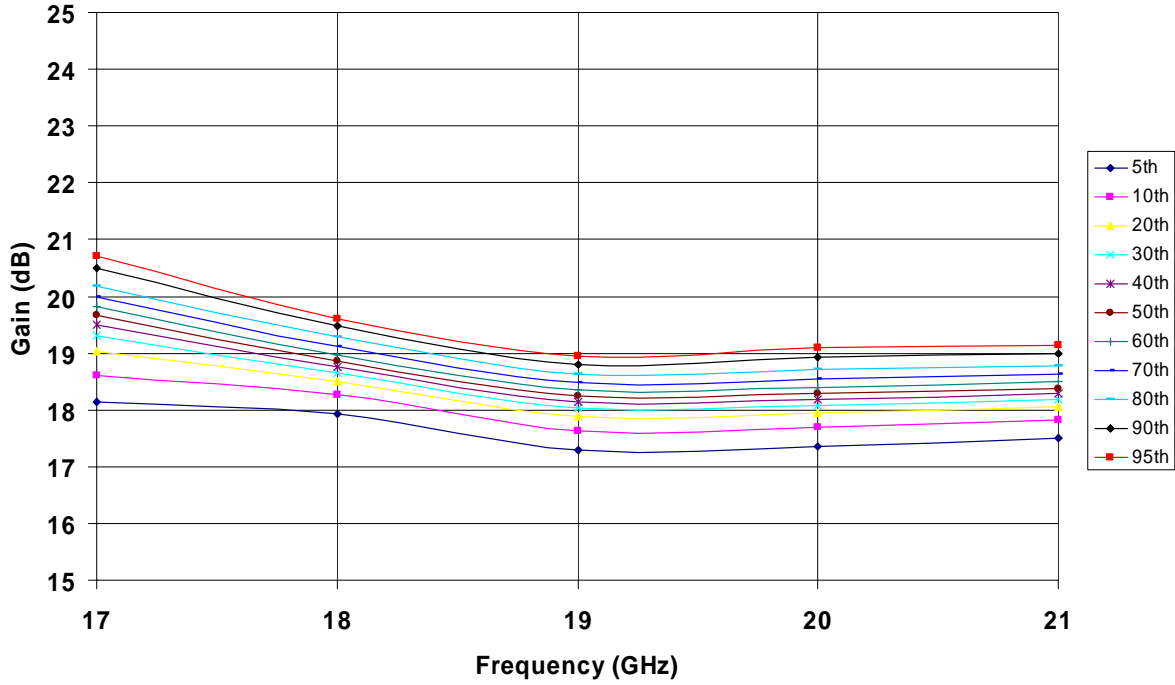

**Typical On-Wafer Electrical Characteristics**

7V, 66mA Self Bias

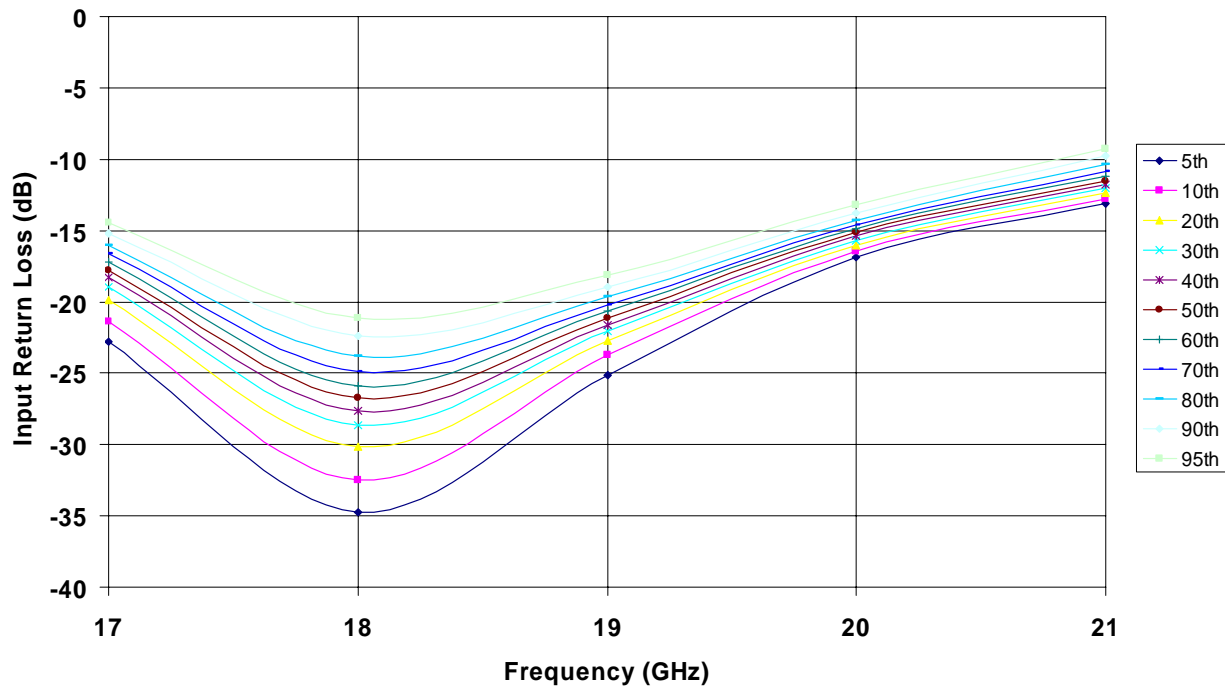
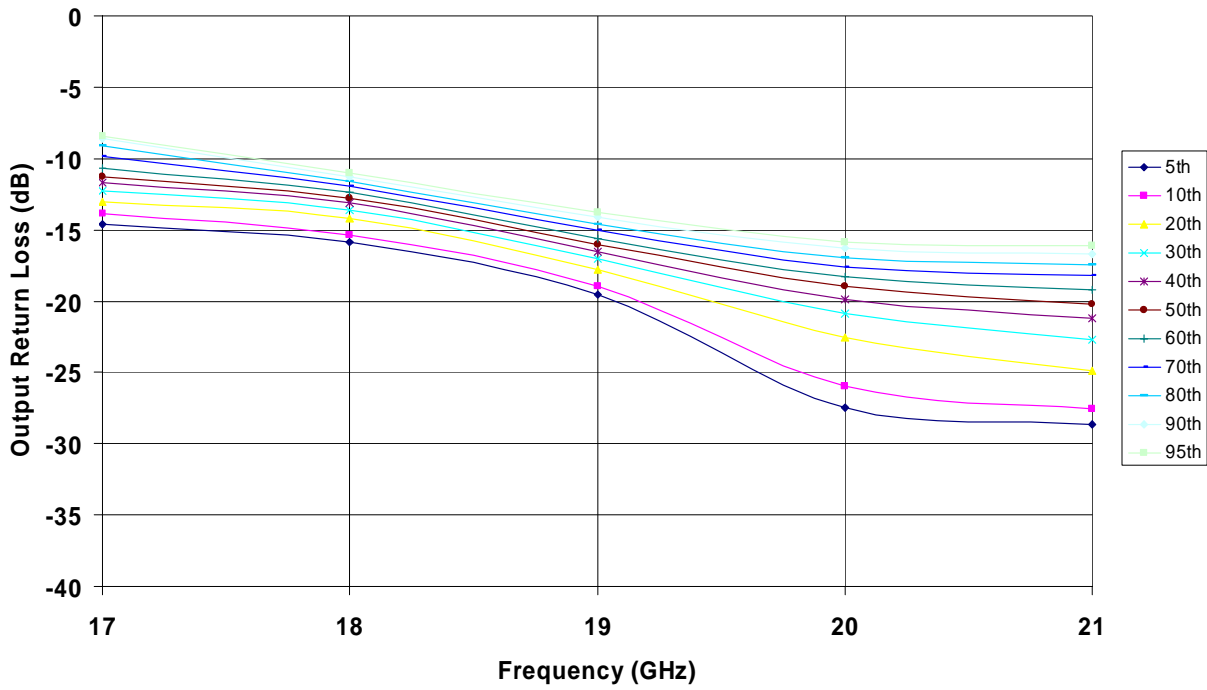

**Mechanical Drawing**

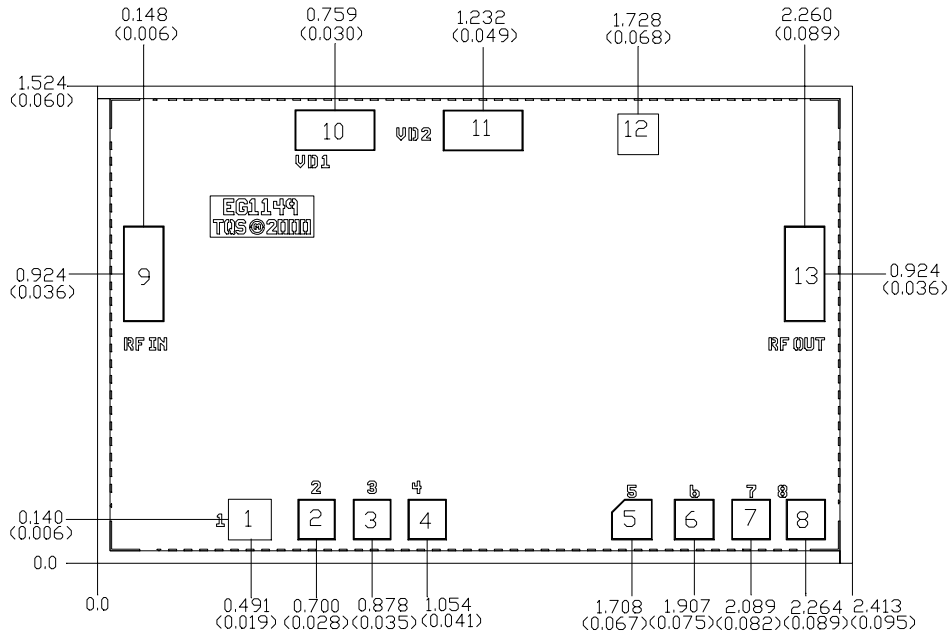

Units: millimeters (inches)

Thickness: 0.100 (0.004)

Chip edge to bond pad dimensions are shown to center of bond pad

Chip size tolerance: +/- 0.051 (0.002)

Bond pad #1 (DC GND)	0.130 x 0.137
Bond pad #2 (Alternate bonding connection)	0.114 x 0.125
Bond pad #3 (Alternate bonding connection)	0.116 x 0.125
Bond pad #4 (Alternate bonding connection)	0.118 x 0.125
Bond pad #5 (DC GND)	0.125 x 0.125
Bond pad #6 (Alternate bonding connection)	0.125 x 0.123
Bond pad #7 (Alternate bonding connection)	0.125 x 0.119
Bond pad #8 (Alternate bonding connection)	0.125 x 0.121
Bond pad #9 (RF input)	0.125 x 0.300
Bond pad #10 (VD1)	0.125 x 0.250
Bond pad #11 (VD2)	0.125 x 0.250
Bond pad #12 (DC GND)	0.125 x 0.125
Bond pad #13 (RF output)	0.125 x 0.300

**GaAs MMIC devices are susceptible to damage from Electrostatic Discharge. Proper precautions should be observed during handling, assembly and test.**

**Chip Assembly Diagram**

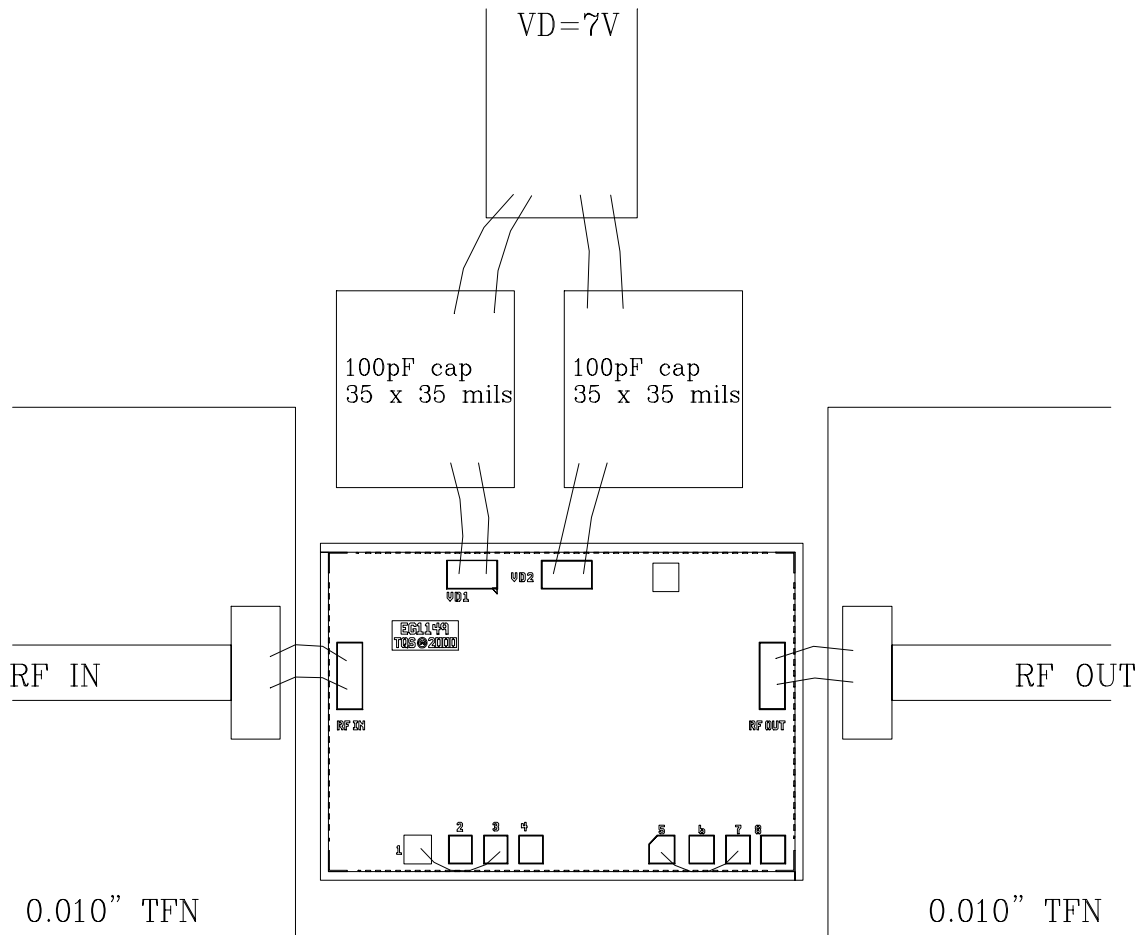

This configuration is for a self-bias logic pad current search with connections for bin G06. See Table V for alternate pad connections corresponding with the bins number listed.

**TABLE V  
PAD CONNECTIONS**

NUMBER	CONNECTION 1	CONNECTION 2	BINS
1	None	None	G01
2	Pad 3 to Pad 4	Pad 7 to Pad 8	G02
3	Pad 2 to Pad 3	Pad 6 to Pad 7	G03
4	Pad 2 to Pad 4	Pad 6 to Pad 8	G04
5	Pad 1 to Pad 2	Pad 5 to Pad 6	G05
6	Pad 1 to Pad 3	Pad 5 to Pad 7	G06
7	Pad 1 to Pad 4	Pad 5 to Pad 8	G07

**GaAs MMIC devices are susceptible to damage from Electrostatic Discharge. Proper precautions should be observed during handling, assembly and test.**

## Assembly Process Notes

Reflow process assembly notes:

- Use AuSn (80/20) solder with limited exposure to temperatures at or above 300°C.
- An alloy station or conveyor furnace with reducing atmosphere should be used.
- No fluxes should be utilized.
- Coefficient of thermal expansion matching is critical for long-term reliability.
- Devices must be stored in a dry nitrogen atmosphere.

Component placement and adhesive attachment assembly notes:

- Vacuum pencils and/or vacuum collets are the preferred method of pick up.
- Air bridges must be avoided during placement.
- The force impact is critical during auto placement.
- Organic attachment can be used in low-power applications.
- Curing should be done in a convection oven; proper exhaust is a safety concern.
- Microwave or radiant curing should not be used because of differential heating.
- Coefficient of thermal expansion matching is critical.

Interconnect process assembly notes:

- Thermosonic ball bonding is the preferred interconnect technique.
- Force, time, and ultrasonics are critical parameters.
- Aluminum wire should not be used.
- Discrete FET devices with small pad sizes should be bonded with 0.0007-inch wire.
- Maximum stage temperature is 200°C.

***GaAs MMIC devices are susceptible to damage from Electrostatic Discharge. Proper precautions should be observed during handling, assembly and test.***