

# TGA4543

## 40.5 - 43.5 GHz Power Amplifier

### Applications

- Point to Point Radio
- Millimeter-wave Communications
- Military & Space

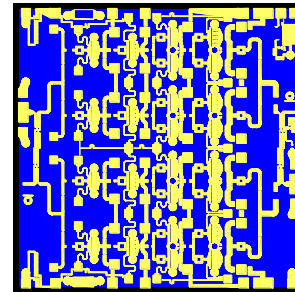

### Product Features

- Frequency range: 40.5 - 43.5 GHz
- Output Power: 30 dBm Psat, 28.5 dBm P1dB
- Gain: 23 dBm Typical
- TOI: 38 dBm @ 18 dBm Output/Tone
- Integrated Power Detector
- Bias: Vcc = 6V, Icc = 900 mA Typical
- Dimension: 2.95 x 2.95 x 0.1 mm

### General Description

The TriQuint TGA4543 is a 40.5 - 43.5 GHz Power Amplifier designed using TriQuint's power pHEMT production process.

The TGA4543 typically provides 28.5 dBm of output power at 1dB gain compression with small signal gain of 23 dB. Third Order Intercept is 38 dBm at 18 dBm Output/Tone.

The TGA4543 is ideally suited for Point-to-Point Radio, Ka-band communications, and Millimeter-wave communications.

Lead-free and RoHS compliant.

Evaluation Boards are available upon request.

### Functional Block Diagram

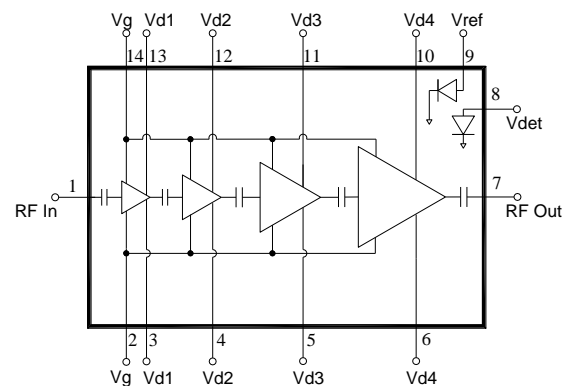

### Bond Pad Configuration

Bond Pad #	Function Label
1	RF In
2, 14	Vg
3, 4, 5, 6, 10, 11, 12, 13	Vd
7	RF Out
8	Vdet
9	Vref

### Ordering Information

Part No.	ECCN	Description
TGA4543	3A001.b.2.e	40.5 – 43.5 GHz Power Amplifier

Standard order qty = 50 pieces.

# TGA4543

## 40.5 - 43.5 GHz Power Amplifier



### Specifications

#### Absolute Maximum Ratings

Parameter	Rating
Drain to Gate Voltage, Vd - Vg	10V
Drain Voltage, Vd	+6.5 V
Gate Voltage, Vg	-4 to 0 V
Drain Current, Id	2086 mA
Gate Current, Ig	-8.2 to 113 mA
Power Dissipation, P <sub>diss</sub>	13.6 W
RF Input Power, CW, 50Ω, T=25°C	26 dBm
Channel Temperature, T <sub>ch</sub>	200°C
Mounting Temperature (30 Seconds)	320°C
Storage Temperature	-40 to 150°C

Operation of this device outside the parameter ranges given above may cause permanent damage.

#### Recommended Operating Conditions

Parameter	Min	Typ	Max	Units
Operating Temp. Range	-40	+25	+85	°C
Vd		6.0		V
Id		900		mA
Id (Under RF Drive)		1500		mA
Vg		-0.7		V

Electrical specifications are measured at specified test conditions. Specifications are not guaranteed over all recommended operating conditions.

#### Electrical Specifications

Test conditions unless otherwise noted: 25 °C, Vd = 6 V, Id = 900mA, Vg = -0.7 V Typical.

Parameter	Conditions	Min	Typ	Max	Units
Operational Frequency Range		40.5		43.5	GHz
Gain			23		dB
Input Return Loss			8		dB
Output Return Loss			10		dB
Output Power	Saturation		30		dBm
Output Power	1dB Gain Compression		28.5		dBm
Output TOI	18 dBm Output/Tone		38		dBm
Gain Temperature Coefficient			-0.04		dB/°C
Power Temperature Coefficient	1dB Gain Compression		-0.023		dB/°C

### Specifications

#### Thermal and Reliability Information

Parameter	Condition	Rating
Thermal Resistance, $\theta_{JC}$ , measured to back of package, Small-Signal Under RF Drive	Tbase = 70 °C	$\theta_{JC} = 7.6 \text{ }^\circ\text{C/W}$ $\theta_{JC} = 10.4 \text{ }^\circ\text{C/W}$
Channel Temperature (Tch), and Median Lifetime (Tm)	Tbase = 70 °C, Vd = 6 V, Id = 900 mA, Pdis = 5.4 W	Tch = 111 °C Tm = 2.2E+7 Hours
Channel Temperature (Tch), and Median Lifetime (Tm) Under RF Drive	Tbase = 70 °C, Vd = 6 V, Id = 1500 mA, Pout = 30.5 dBm, Pdis = 7.9 W	Tch = 152 °C Tm = 8.3 E+5 Hours

Note: Thermal model includes 38um AuSn bondline and 500um CuMo thermal spreader

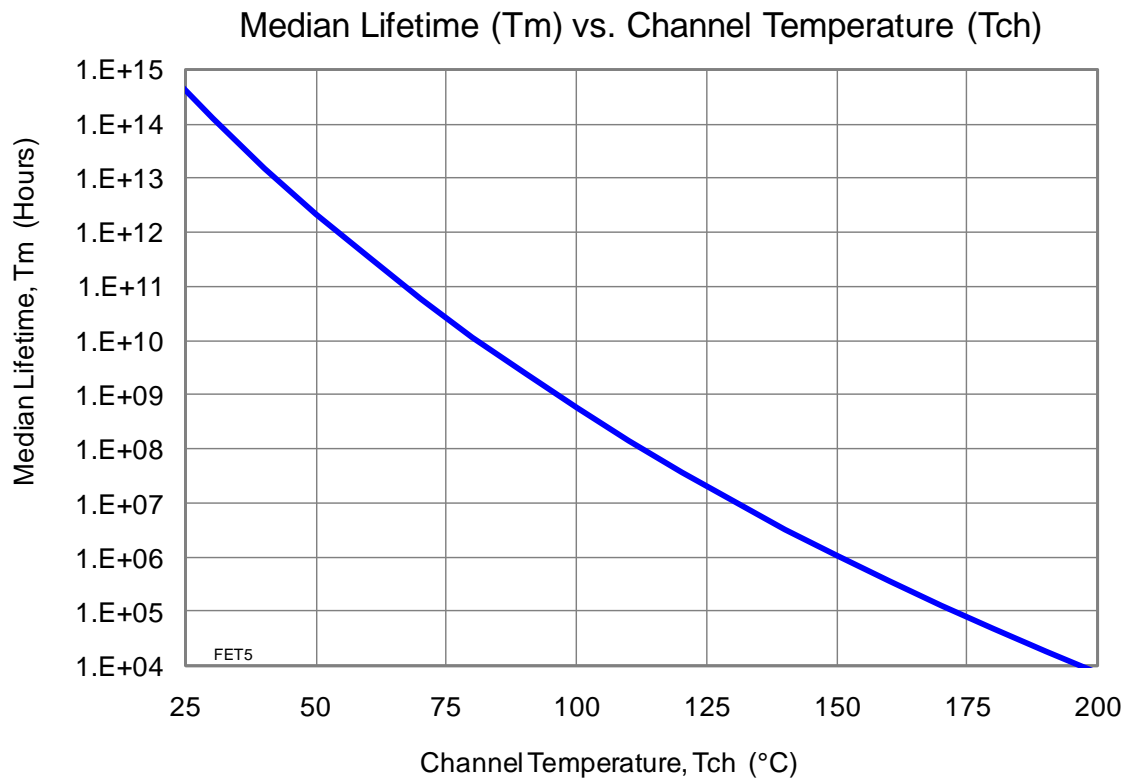

# TGA4543

*40.5 - 43.5 GHz Power Amplifier*

---



### Typical Performance

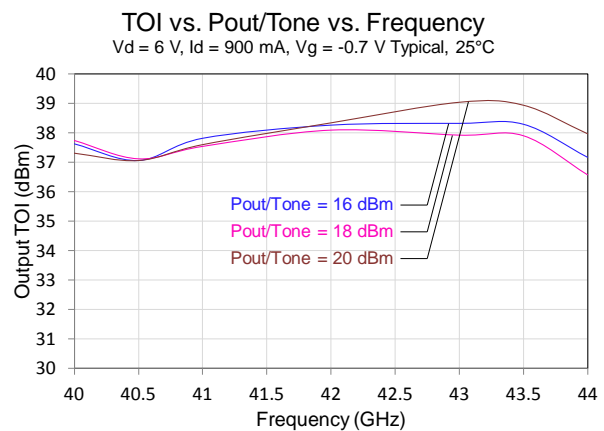
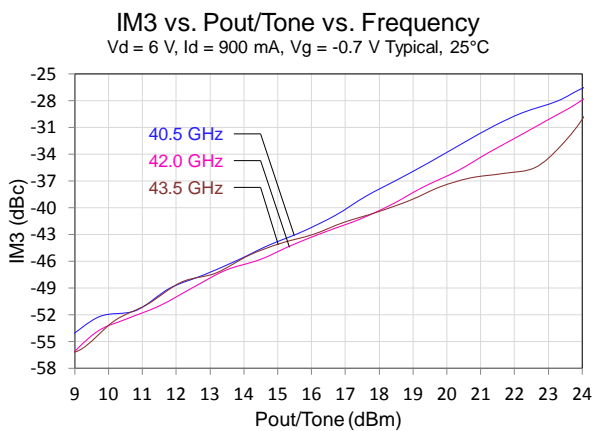
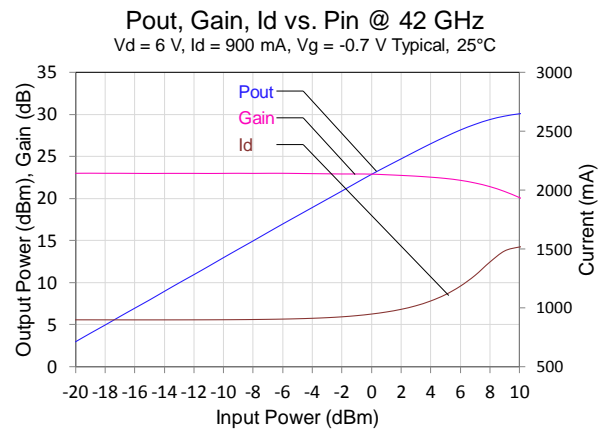
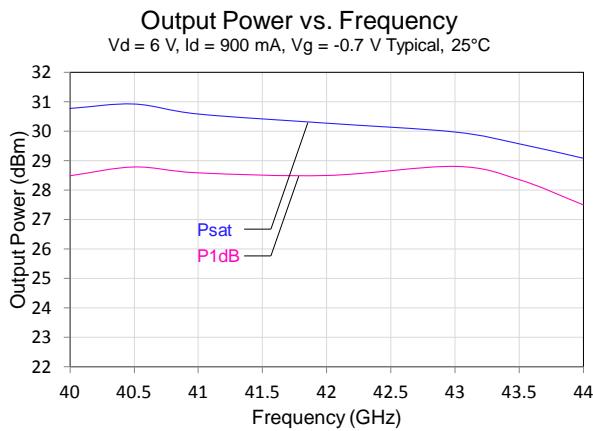
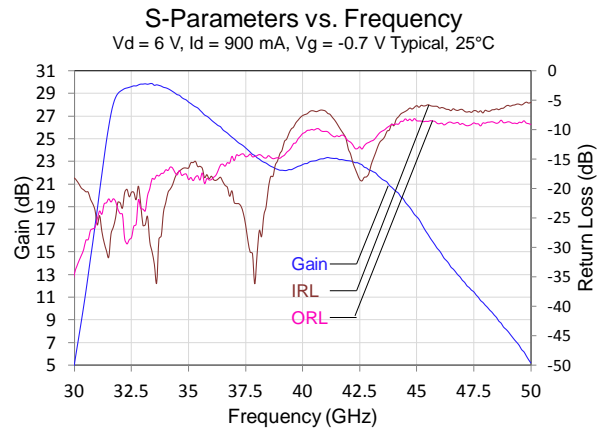
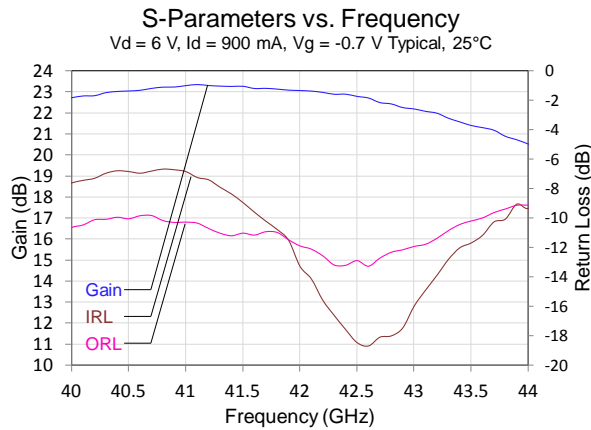

### Typical Performance

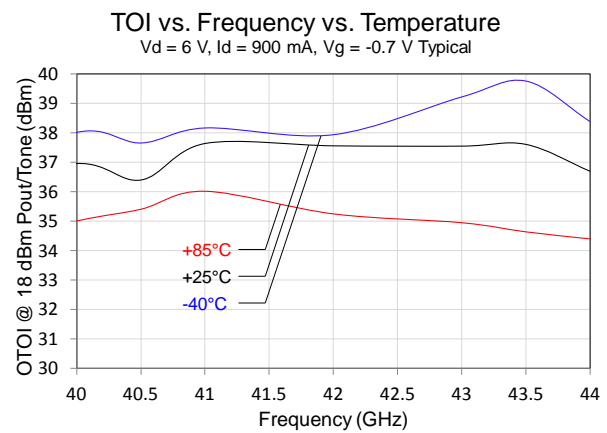
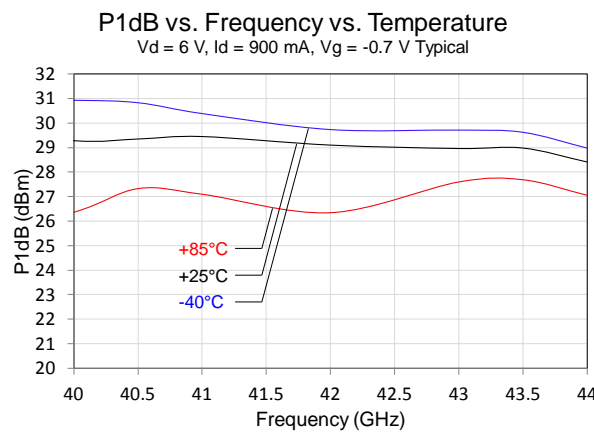
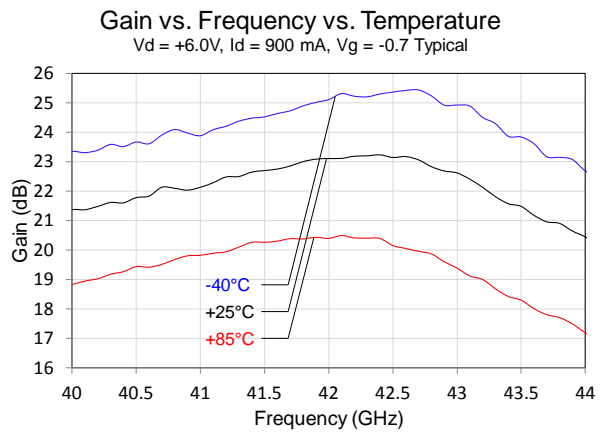
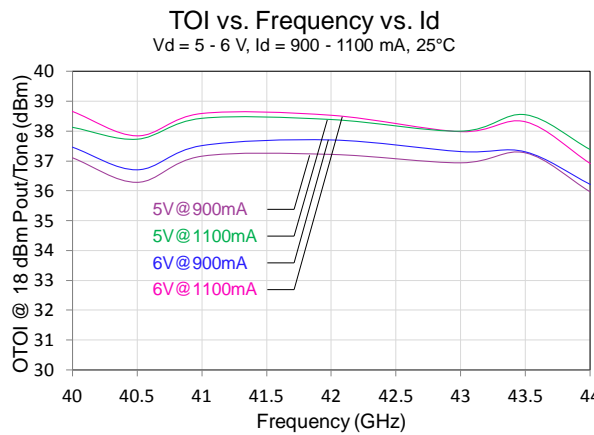
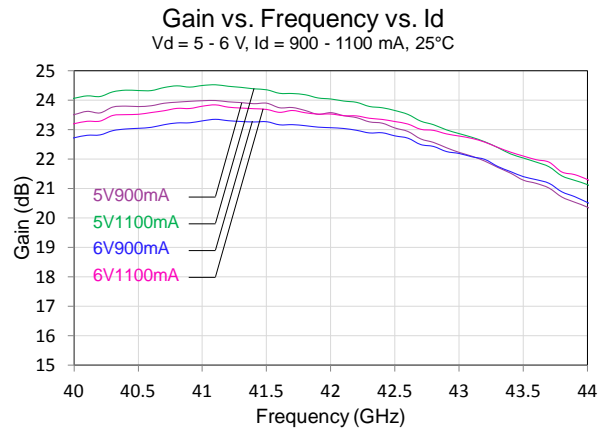
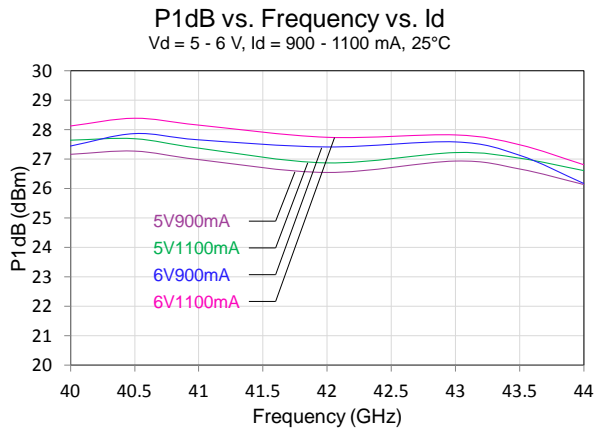

### Typical Performance

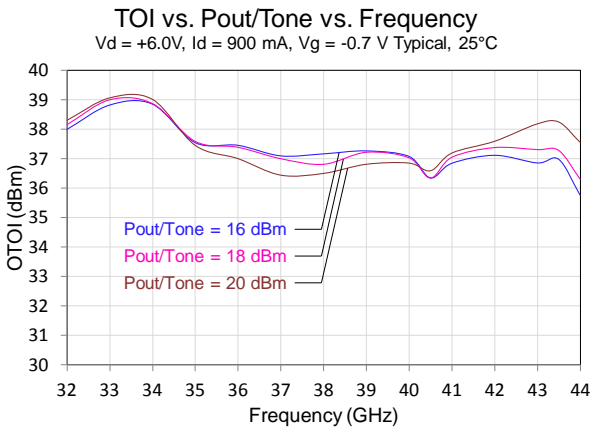
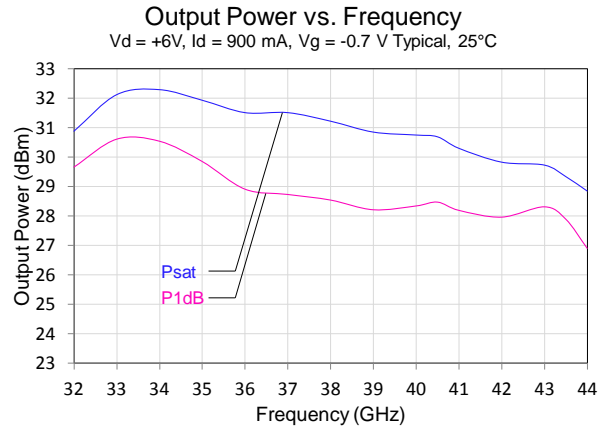
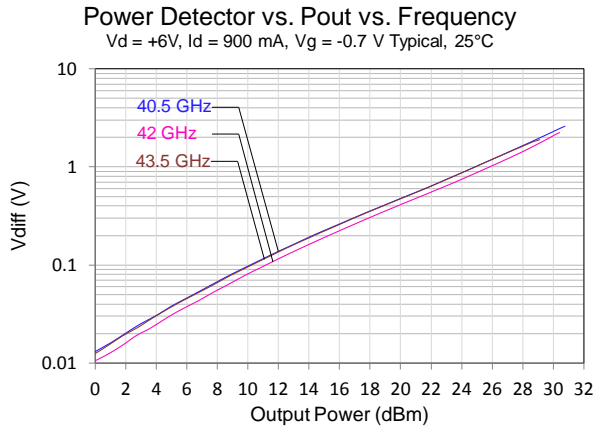

# TGA4543

## 40.5 - 43.5 GHz Power Amplifier

### Bond Pad Description

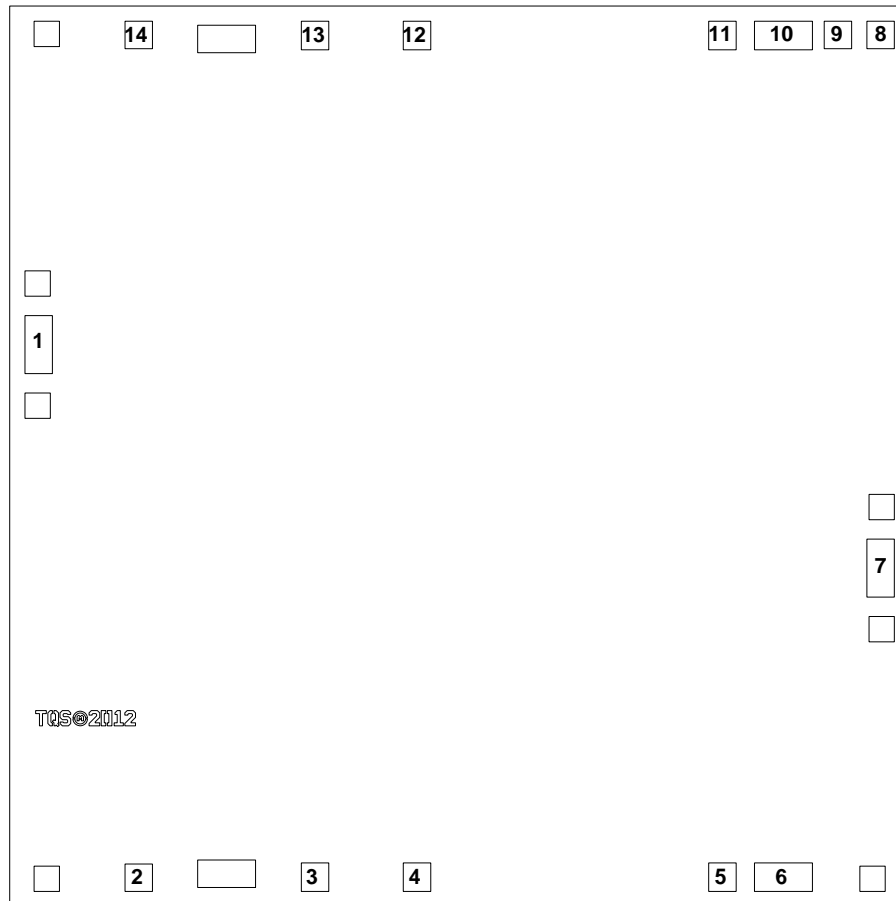

Bond Pad	Symbol	Description
1	RF In	Input, matched to 50 ohms
2, 14	Vg	Gate voltage. ESD protection included; Bias network is required; see Application Circuit on page 7 as an example.
3, 4, 5, 6, 10, 11, 12, 13	Vd	Drain voltage. Bias network is required; must be biased from both sides; see Application Circuit on page 7 as an example.
7	RF Out	Output, matched to 50 ohms.
8	Vdet	Detector diode output voltage. Varies with RF output power.
9	Vref	Reference diode output voltage.



# TGA4543

## 40.5 - 43.5 GHz Power Amplifier

### Application Circuit

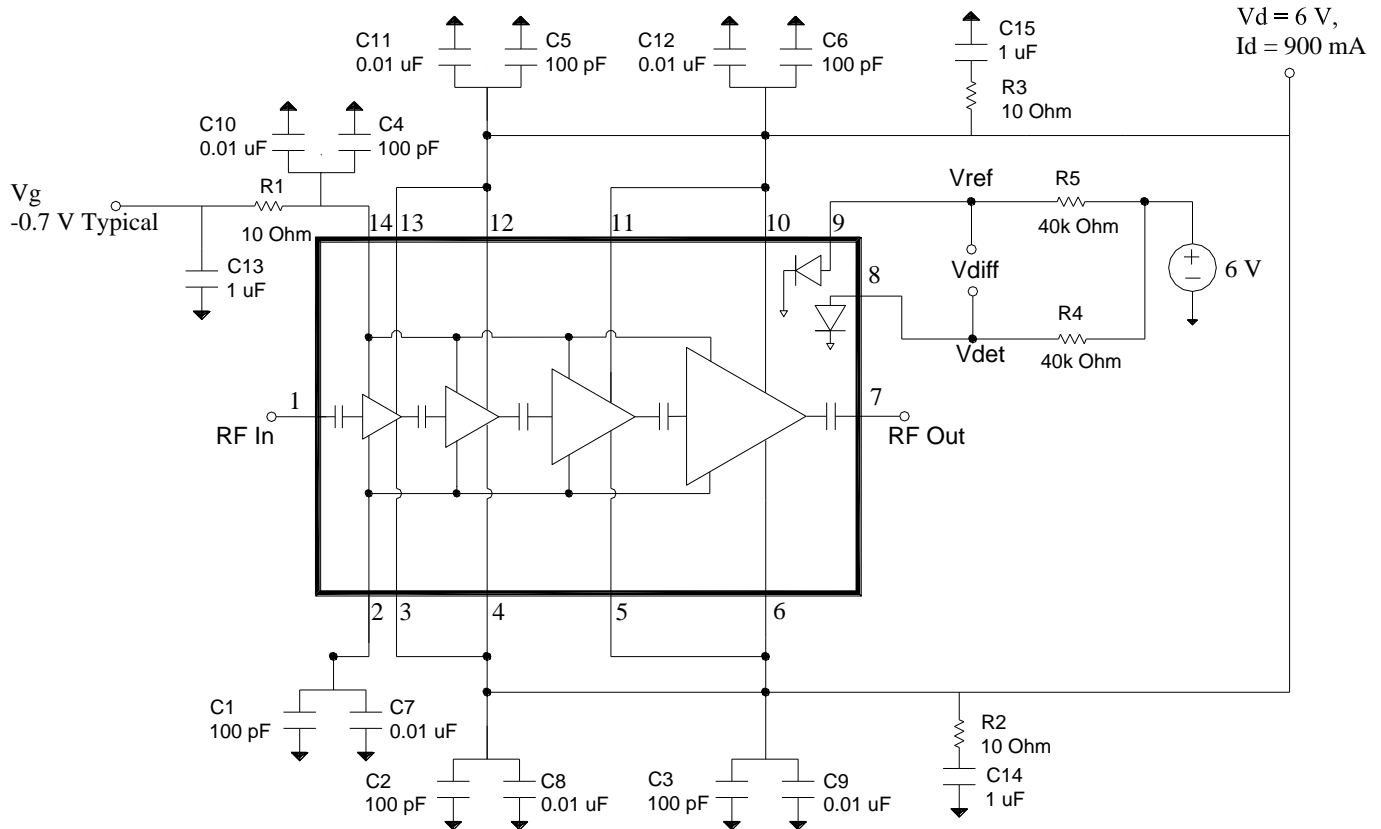

Vd must be biased from both sides. Vg can be biased from either side.

Bias-up Procedure	Bias-down Procedure
Vg set to -1.5 V	Turn off RF supply
Vd set to +6 V	Reduce Vg to -1.5V. Ensure Id ~ 0 mA
Adjust Vg more positive until quiescent Id is 900 mA. This will be ~ Vg = -0.7 V	Turn Vd to 0 V
Apply RF signal to RF Input	Turn Vg to 0 V

# TGA4543

## 40.5 - 43.5 GHz Power Amplifier

### Application Circuit

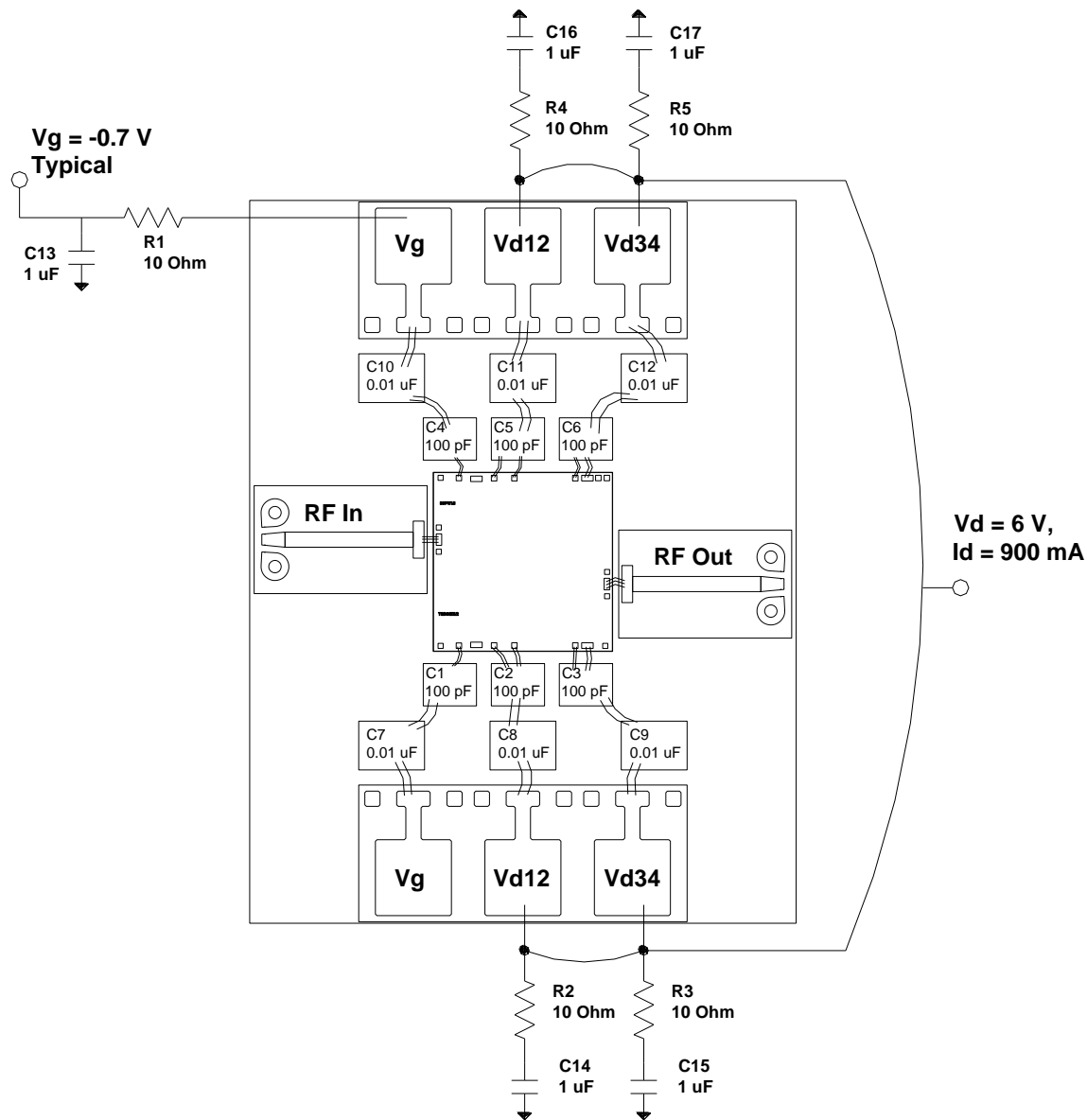

### Bill of Material

Ref Des	Value	Description	Manufacturer	Part Number
C1, C2, C3, C4, C5, C6	100 pF	Cap, 50V, 10%, Single Layer Cap	various	
C7, C8, C9, C10, C11, C12	0.01 $\mu$ F	Cap, 50V, 10%, SMD	various	

# TGA4543

## 40.5 - 43.5 GHz Power Amplifier



### Mechanical Information

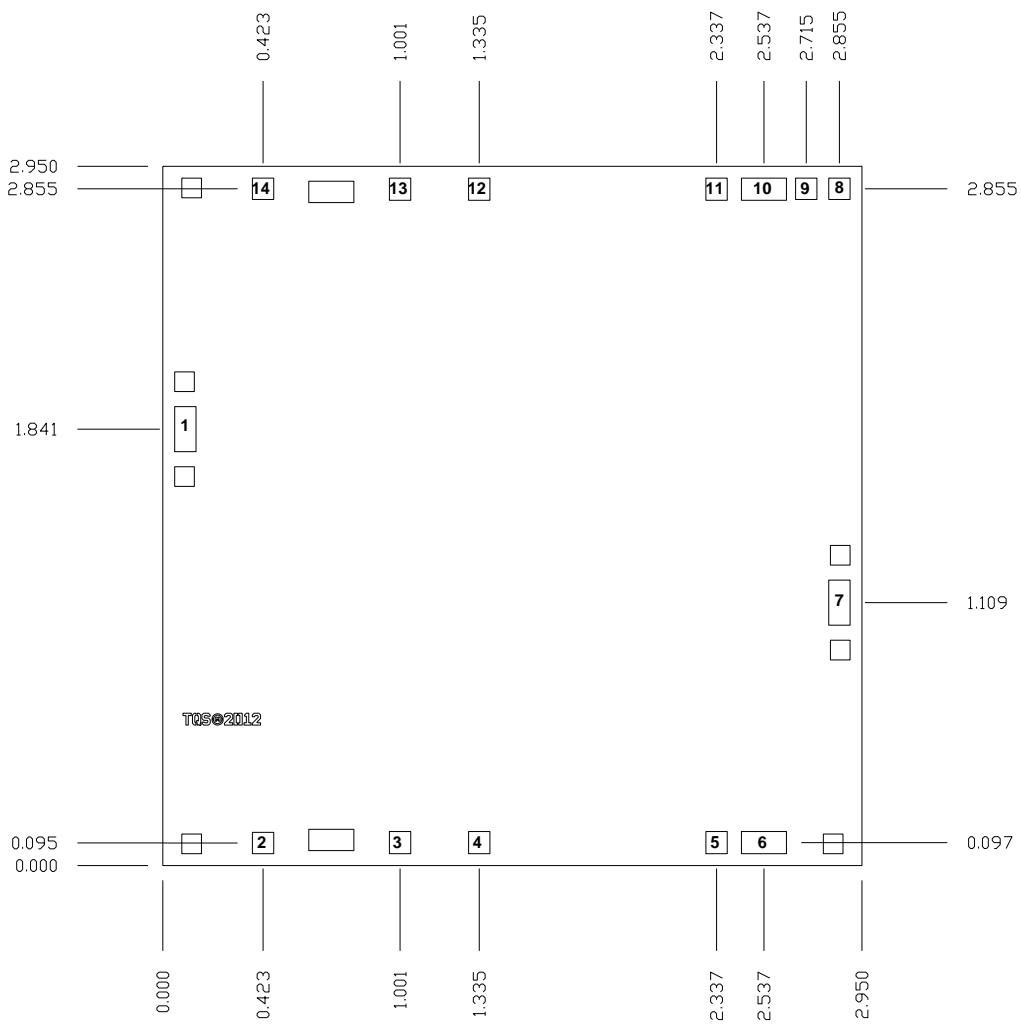

Unit: millimeters  
 Thickness: 0.10  
 Die x, y size tolerance: +/- 0.050  
 Chip edge to bond pad dimensions are shown to center of pad  
 Ground is backside of die

Bond Pad	Symbol	Pad Size
1	RF In	0.190 x 0.090
2, 14	Vg	0.090 x 0.090
3, 4, 5, 11, 12, 13	Vd	0.093 x 0.090
6, 10	Vd	0.093 x 0.190
7	RF Out	0.190 x 0.090
8	Vdet	0.090 x 0.090
9	Vref	0.090 x 0.090

### Product Compliance Information

#### ESD Information



#### Caution! ESD-Sensitive Device

ESD Rating: Class 0  
Value: Passes 150V  
Test: Human Body Model (HBM)  
Standard: JEDEC Standard JESD22-A114

#### Solderability

Compatible with both lead-free (260 °C max. reflow temp.) and tin/lead (245 °C max. reflow temp.) soldering processes.

#### RoHS Compliance

This part is compliant with EU 2002/95/EC RoHS directive (Restrictions on the Use of Certain Hazardous Substances in Electrical and Electronic Equipment).

This product also has the following attributes:

- Lead Free
- Halogen Free (Chlorine, Bromine)
- Antimony Free
- TBBP-A (C<sub>15</sub>H<sub>12</sub>Br<sub>4</sub>O<sub>2</sub>) Free
- PFOS Free
- SVHC Free

### Assembly Notes

Component placement and adhesive attachment assembly notes:

- Vacuum pencils and/or vacuum collets are the preferred method of pick up.
- Air bridges must be avoided during placement.
- The force impact is critical during auto placement.
- Organic attachment (i.e. epoxy) can be used in low-power applications.
- Curing should be done in a convection oven; proper exhaust is a safety concern.

Reflow process assembly notes:

- Use AuSn (80/20) solder and limit exposure to temperatures above 300°C to 3-4 minutes, maximum.
- An alloy station or conveyor furnace with reducing atmosphere should be used.
- Do not use any kind of flux.
- Coefficient of thermal expansion matching is critical for long-term reliability.
- Devices must be stored in a dry nitrogen atmosphere.

Interconnect process assembly notes:

- Thermosonic ball bonding is the preferred interconnect technique.
- Force, time, and ultrasonics are critical parameters.
- Aluminum wire should not be used.
- Devices with small pad sizes should be bonded with 0.0007-inch wire.

# TGA4543

## 40.5 - 43.5 GHz Power Amplifier



### Contact Information

For the latest specifications, additional product information, worldwide sales and distribution locations, and information about TriQuint:

Web: [www.triquint.com](http://www.triquint.com)  
Email: [info-sales@tqs.com](mailto:info-sales@tqs.com)

Tel: +1.972.994.8465  
Fax: +1.972.994.8504

For technical questions and application information:

Email: [info-networks@tqs.com](mailto:info-networks@tqs.com)

### Important Notice

The information contained herein is believed to be reliable. TriQuint makes no warranties regarding the information contained herein. TriQuint assumes no responsibility or liability whatsoever for any of the information contained herein. TriQuint assumes no responsibility or liability whatsoever for the use of the information contained herein. The information contained herein is provided "AS IS, WHERE IS" and with all faults, and the entire risk associated with such information is entirely with the user. All information contained herein is subject to change without notice. Customers should obtain and verify the latest relevant information before placing orders for TriQuint products. The information contained herein or any use of such information does not grant, explicitly or implicitly, to any party any patent rights, licenses, or any other intellectual property rights, whether with regard to such information itself or anything described by such information.

TriQuint products are not warranted or authorized for use as critical components in medical, life-saving, or life-sustaining applications, or other applications where a failure would reasonably be expected to cause severe personal injury or death.