

BTS Driver

Broadband Amplifier

The MMG38151BT1 is a general purpose amplifier that is internally input and output matched. It is designed for a broad range of Class A, small-signal, high linearity, general purpose applications. It is suitable for applications with frequencies from 0 to 6000 MHz such as cellular, PCS, BWA, WLL, PHS, CATV, VHF, UHF, UMTS and general small-signal RF.

Features

- Frequency: 0 to 6000 MHz
- P1dB: 13.4 dBm @ 3800 MHz
- Small-Signal Gain: 17.1 dB @ 3800 MHz
- Third Order Output Intercept Point: 25.0 dBm @ 3800 MHz
- Single 5 V Supply
- Internally Matched to 50 Ohms
- Cost-effective SOT-89 Surface Mount Package
- In Tape and Reel. T1 Suffix = 1,000 Units, 12 mm Tape Width, 7-inch Reel.

MMG38151BT1

**0-6000 MHz, 17.1 dB @ 3800 MHz
13.4 dBm
BTS Driver**



SOT-89

Table 1. Typical Performance (1)

Characteristic	Symbol	900 MHz	2140 MHz	2700 MHz	3800 MHz	Unit
Small-Signal Gain (S21)	G_p	19.4	17.8	17.2	17.1	dB
Input Return Loss (S11)	IRL	-14.7	-16.8	-10.8	-11.0	dB
Output Return Loss (S22)	ORL	-22.0	-10.4	-8.7	-14.4	dB
Power Output @1dB Compression	P1dB	18.4	15.8	15.0	13.4	dBm
Third Order Output Intercept Point	OIP3	31.8	27.9	27.0	25.0	dBm

Table 2. Maximum Ratings

Rating	Symbol	Value	Unit
Supply Voltage	V_{CC}	7	V
Supply Current	I_{CC}	250	mA
RF Input Power	P_{in}	10	dBm
Storage Temperature Range	T_{stg}	-65 to +150	°C
Junction Temperature	T_J	175	°C

Table 3. Thermal Characteristics

Characteristic	Symbol	Value (2)	Unit
Thermal Resistance, Junction to Case Case Temperature 85°C, 5 Vdc, 50 mA, no RF applied	$R_{\theta JC}$	57	°C/W

1. $V_{CC} = 5$ Vdc, $T_A = 25^\circ\text{C}$, 50 ohm system.

2. Refer to AN1955, *Thermal Measurement Methodology of RF Power Amplifiers*. Go to <http://www.freescale.com/rf>.
Select Documentation/Application Notes - AN1955.

Table 4. Electrical Characteristics ($V_{CC} = 5$ Vdc, 900 MHz, $T_A = 25^\circ\text{C}$, 50 ohm system, in Freescale Application Circuit)

Characteristic	Symbol	Min	Typ	Max	Unit
Small-Signal Gain (S21)	G_p	18	19.4	—	dB
Input Return Loss (S11)	IRL	—	-14.7	—	dB
Output Return Loss (S22)	ORL	—	-22.0	—	dB
Power Output @ 1dB Compression	P1dB	—	18.4	—	dBm
Third Order Output Intercept Point	OIP3	—	31.8	—	dBm
Noise Figure	NF	—	3.2	—	dB
Supply Current	I_{CC}	39	47	55	mA
Supply Voltage	V_{CC}	—	5	—	V

Table 5. ESD Protection Characteristics

Test Methodology	Class
Human Body Model (per JESD 22-A114)	1A
Machine Model (per EIA/JESD 22-A115)	A
Charge Device Model (per JESD 22-C101)	IV

Table 6. Moisture Sensitivity Level

Test Methodology	Rating	Package Peak Temperature	Unit
Per JESD 22-A113, IPC/JEDEC J-STD-020	1	260	$^\circ\text{C}$

Table 7. Functional Pin Description

Pin Number	Pin Function
1	RF_{in}
2	Ground
3	RF_{out}/DC Supply

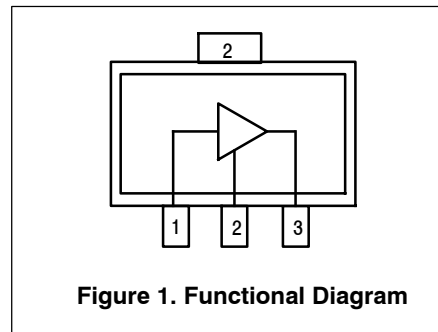
**Figure 1. Functional Diagram**

50 OHM APPLICATION CIRCUIT: 300-6000 MHz

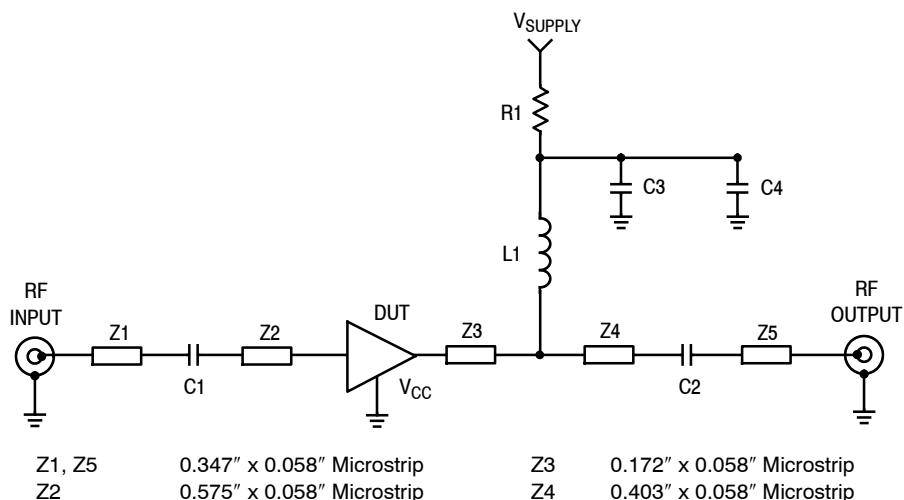

Figure 2. 50 Ohm Test Circuit Schematic

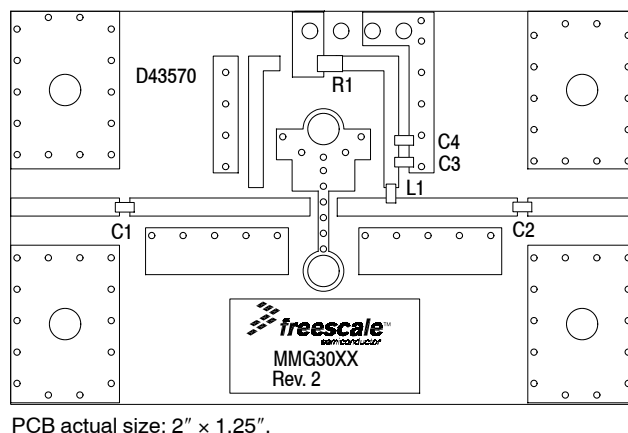

Figure 3. 50 Ohm Test Circuit Component Layout

Table 8. 50 Ohm Test Circuit Component Designations and Values

Part	Description	Part Number	Manufacturer
C1, C2	150 pF Chip Capacitors	C0603C151J5RAC	Kemet
C3	0.01 μ F Chip Capacitor	C0603C103J5RAC	Kemet
C4	1000 pF Chip Capacitor	C0603C102J5RAC	Kemet
L1	56 nH Chip Inductor	HK160856NJ-T	Taiyo Yuden
R1	0 Ω Chip Resistor	ERJ3GEY0R00V	Panasonic
PCB	Getek Grade ML200C, 0.031", $\epsilon_r = 4.1$	D43570	MTL

50 OHM TYPICAL CHARACTERISTICS: 300-6000 MHz

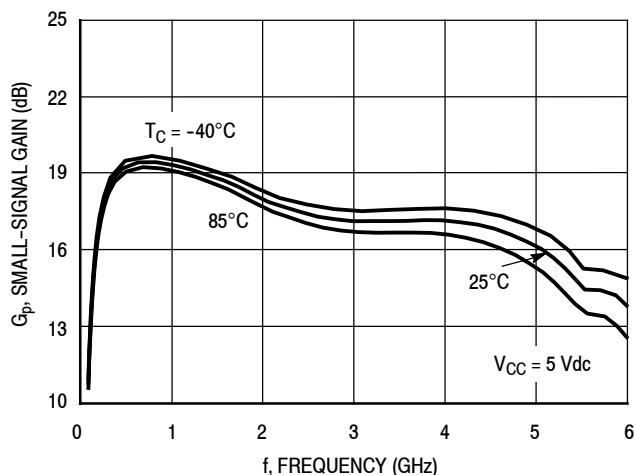

Figure 4. Small-Signal Gain (S21) versus Frequency

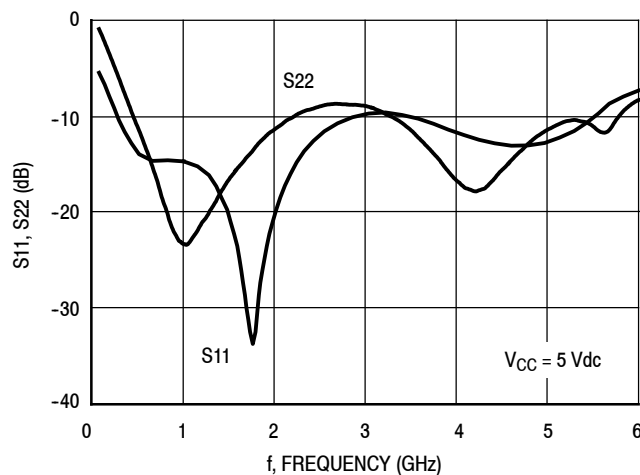

Figure 5. Input/Output Return Loss versus Frequency

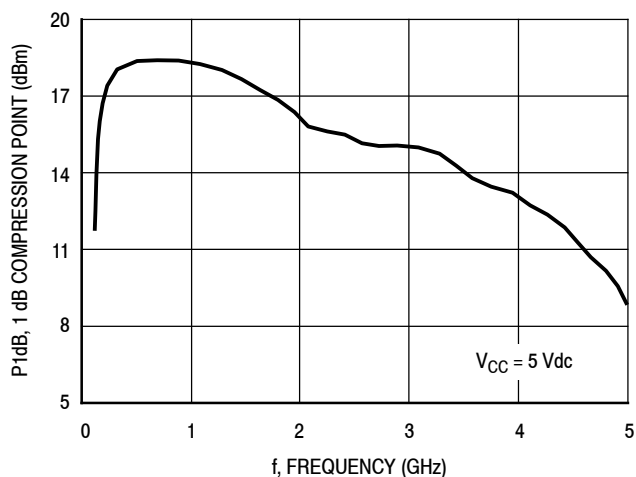

Figure 6. P1dB versus Frequency

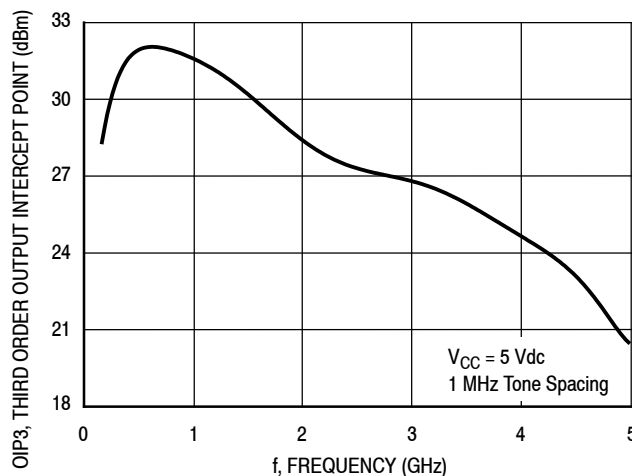

Figure 7. Third Order Output Intercept Point versus Frequency

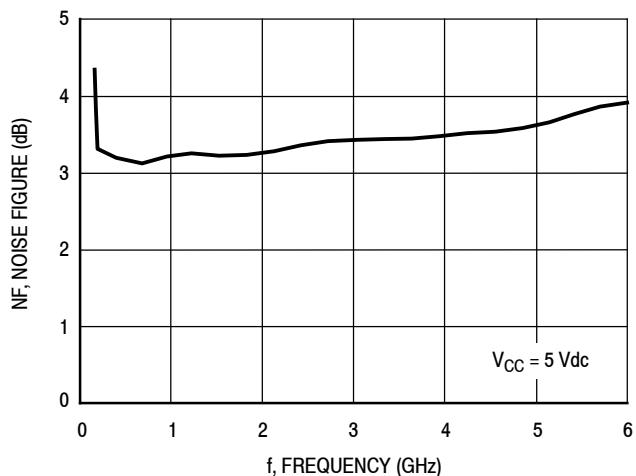

Figure 8. Noise Figure versus Frequency

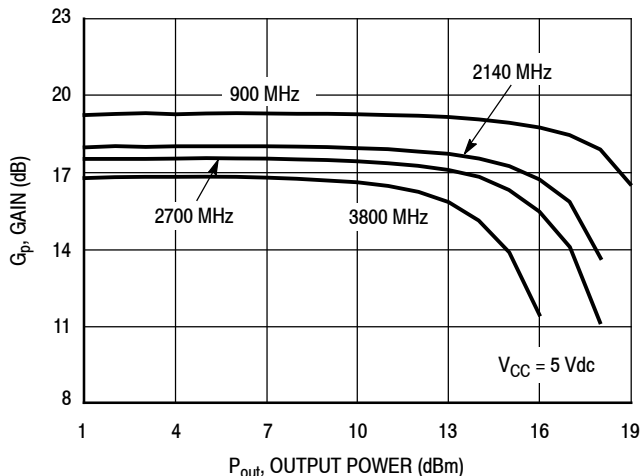

Figure 9. Gain versus Output Power

50 OHM TYPICAL CHARACTERISTICS: 300-6000 MHz

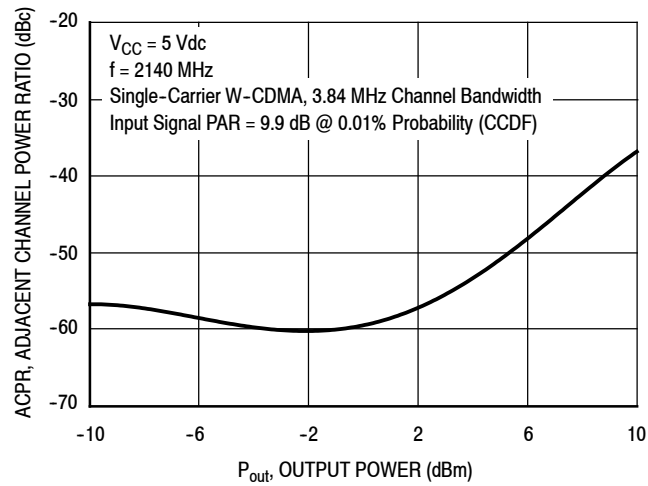

Figure 10. Single-Carrier W-CDMA Adjacent Channel Power Ratio versus Output Power

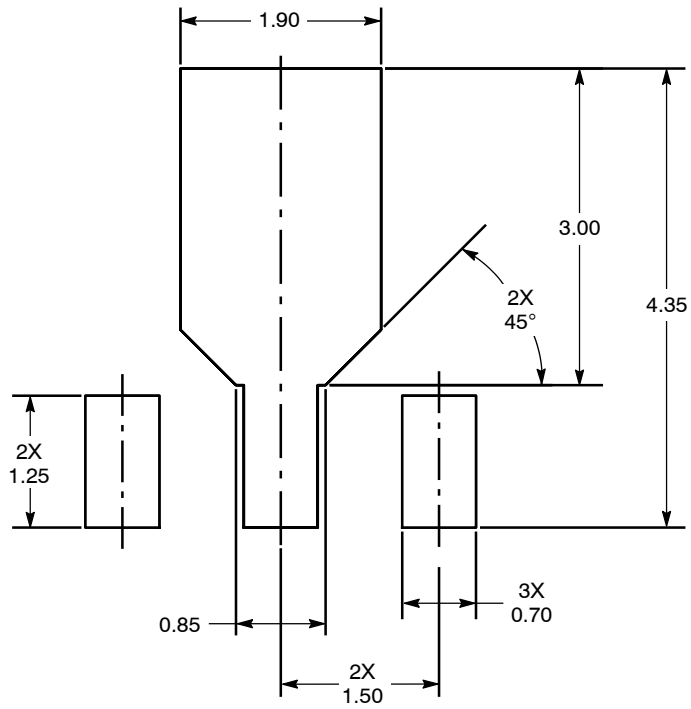

Figure 11. PCB Pad Layout for SOT-89A

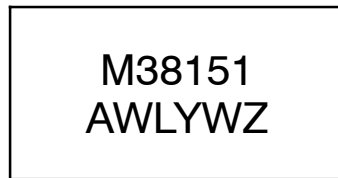
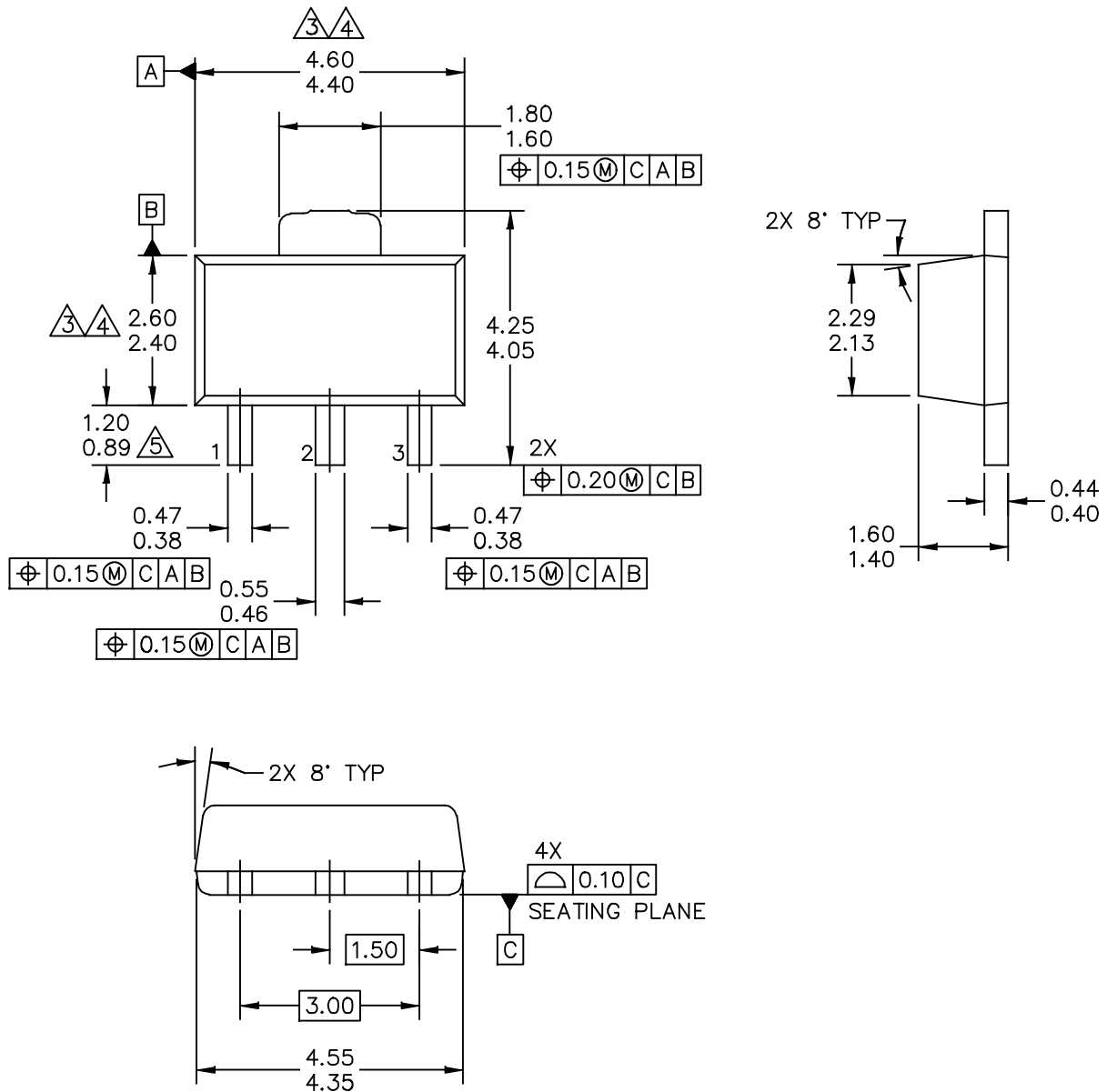

Figure 12. Product Marking

PACKAGE DIMENSIONS



© FREESCALE SEMICONDUCTOR, INC. ALL RIGHTS RESERVED.	MECHANICAL OUTLINE	PRINT VERSION NOT TO SCALE	
TITLE: SOT-89A, 3 LEAD, 4.5 X 2.5 PKG, 1.5 MM PITCH	DOCUMENT NO: 98ASA00241D	REV: 0	
	CASE NUMBER: 2142-01	15 JUL 2010	
	STANDARD: NON-JEDEC		

MMG38151BT1

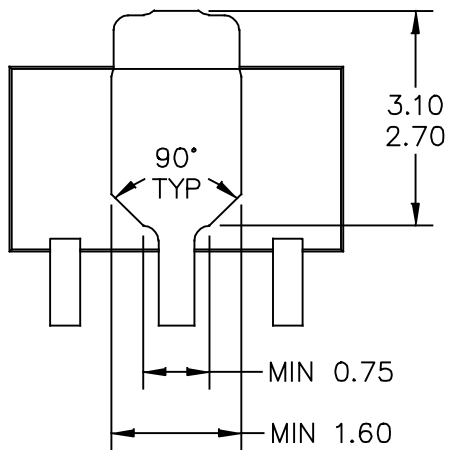

BOTTOM VIEW

© FREESCALE SEMICONDUCTOR, INC. ALL RIGHTS RESERVED.	MECHANICAL OUTLINE	PRINT VERSION NOT TO SCALE	
TITLE: SOT-89A, 3 LEAD, 4.5 X 2.5 PKG, 1.5 MM PITCH	DOCUMENT NO: 98ASA00241D	REV: 0	
	CASE NUMBER: 2142-01	15 JUL 2010	
	STANDARD: NON-JEDEC		

NOTES:

1. DIMENSIONING AND TOLERANCING PER ASME Y14.5M – 1994.

2. ALL DIMENSIONS ARE IN MILLIMETERS.

3. DIMENSIONS DOES NOT INCLUDE MOLD FLASH. PROTRUSIONS OR GATE BURRS. MOLD FLASH, PROTRUSIONS OR GATE BURRS SHALL NOT EXCEED 0.5 MM PER END. DIMENSION DOES NOT INCLUDE INTERLEAD FLASH OR PROTRUSION. INTERLEAD FLASH OR PROTRUSION SHALL NOT EXCEED 0.5 MM PER SIDE.

4. DIMENSION ARE DETERMINED AT THE OUTMOST EXTREMES OF THE PLASTIC BODY EXCLUSIVE OF MOLD FLASH, TIE BAR BURRS, GATE BURRS AND INTERLEAD FLASH, BUT INCLUDING ANY MISMATCH BETWEEN THE TOP AND BOTTOM OF THE PLASTIC BODY.

5. TERMINAL NUMBERS ARE SHOWN FOR REFERENCE ONLY.

© FREESCALE SEMICONDUCTOR, INC. ALL RIGHTS RESERVED.	MECHANICAL OUTLINE	PRINT VERSION NOT TO SCALE	
TITLE: SOT-89A, 3 LEAD, 4.5 X 2.5 PKG, 1.5 MM PITCH	DOCUMENT NO: 98ASA00241D	REV: 0	
	CASE NUMBER: 2142-01	15 JUL 2010	
	STANDARD: NON-JEDEC		

PRODUCT DOCUMENTATION, SOFTWARE AND TOOLS

Refer to the following resources to aid your design process.

Application Notes

- AN1955: Thermal Measurement Methodology of RF Power Amplifiers
- AN3100: General Purpose Amplifier and MMIC Biasing

Software

- .s2p File

Development Tools

- Printed Circuit Boards

For Software and Tools, do a Part Number search at <http://www.freescale.com>, and select the “Part Number” link. Go to the Software & Tools tab on the part’s Product Summary page to download the respective tool.

FAILURE ANALYSIS

At this time, because of the physical characteristics of the part, failure analysis is limited to electrical signature analysis. In cases where Freescale is contractually obligated to perform failure analysis (FA) services, full FA may be performed by third party vendors with moderate success. For updates contact your local Freescale Sales Office.

REVISION HISTORY

The following table summarizes revisions to this document.

Revision	Date	Description
0	July 2014	• Initial Release of Data Sheet.
1	Dec. 2014	• Table 3, Thermal Characteristics: changed case temperature from 78°C to 85°C and thermal resistance from 55°C/W to 57°C/W to reflect recent thermal resistance measurements, p. 1

How to Reach Us:

Home Page:
freescale.com

Web Support:
freescale.com/support

Information in this document is provided solely to enable system and software implementers to use Freescale products. There are no express or implied copyright licenses granted hereunder to design or fabricate any integrated circuits based on the information in this document.

Freescale reserves the right to make changes without further notice to any products herein. Freescale makes no warranty, representation, or guarantee regarding the suitability of its products for any particular purpose, nor does Freescale assume any liability arising out of the application or use of any product or circuit, and specifically disclaims any and all liability, including without limitation consequential or incidental damages. "Typical" parameters that may be provided in Freescale data sheets and/or specifications can and do vary in different applications, and actual performance may vary over time. All operating parameters, including "typicals," must be validated for each customer application by customer's technical experts. Freescale does not convey any license under its patent rights nor the rights of others. Freescale sells products pursuant to standard terms and conditions of sale, which can be found at the following address: freescale.com/SalesTermsandConditions.

Freescale and the Freescale logo are trademarks of Freescale Semiconductor, Inc., Reg. U.S. Pat. & Tm. Off. All other product or service names are the property of their respective owners.

© 2014 Freescale Semiconductor, Inc.

