

Applications

- Point-to-Point Radio
- Military Ku-Band
- Ku-Band Space
- VSAT

Product Features

- 11 to 17 GHz Bandwidth
 - 25 dB Nominal Gain
 - 19 dBm Nominal P1dB
 - Bias: 6 to 9 V, 85 mA Self-Bias
 - pHEMT Technology
- Package Dimensions: 4.0 x 4.0 x 0.9 mm

General Description

The TriQuint TGA2243-SM is a Ku-Band driver amplifier, housed in a 12 lead 4x4 mm QFN package. The TGA2243-SM operates from an RF of 11 to 17 GHz and is designed using TriQuint's pHEMT production process.

The TGA2243-SM typically provides 25 dB of Gain, and 19 dB of P1dB.

Lead-free and RoHS compliant.

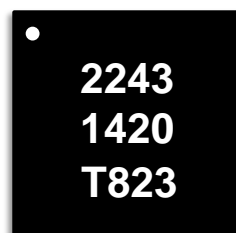

12 lead 4x4mm QFN package

Functional Block Diagram

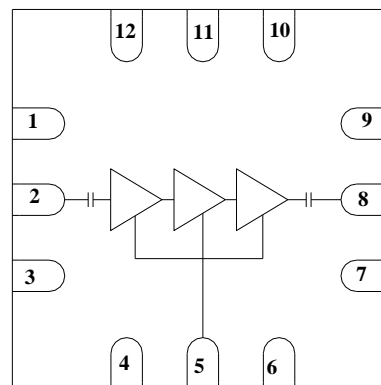

Pin Configuration

Pin No.	Label
1, 3, 4, 6, 7, 9, 10, 11, 12	NC
2	RF IN
5	Vd
8	RF OUT

Ordering Information

Part No.	ECCN	Description
TGA2243-SM	EAR99	Ku-Band Driver Amplifier

Standard T/R size = 500 pieces on a 7" reel

Absolute Maximum Ratings

Parameter	Rating
Drain Voltage, Vd	10 V
Drain Current, Id	114 mA
Power Dissipation, P _{diss}	1.14 W
RF Input Power, CW, 50Ω, T = 25°C	20 dBm
Channel Temperature, T _{ch}	200 °C
Mounting Temperature (30 Seconds)	260 °C
Storage Temperature	-40 to 150 °C

Operation of this device outside the parameter ranges given above may cause permanent damage. These are stress ratings only, and functional operation of the device at these conditions is not implied.

Recommended Operating Conditions

Parameter	Min	Typ	Max	Units
Operating Temp. Range	-40	+25	+85	°C
Vd		7		V
Id		85		mA
Id drive (Under RF Drive)		85		mA

Electrical specifications are measured at specified test conditions. Specifications are not guaranteed over all recommended operating conditions.

Electrical Specifications

Conditions for specifications below unless otherwise noted: $V_d = 7\text{ V}$, $I_d = 85\text{ mA}$ self-bias. Temperature = $+25^\circ\text{C}$

Parameter	Min	Typ	Max	Units
RF Frequency Range	11		17	GHz
Small Signal Gain		25		dB
Input Return Loss, IRL		8		dB
Output Return Loss, ORL		8		dB
Output Power at Saturation, Psat		20		dBm
Output Power at 1dB Gain Compression, P1dB		19		dBm
Output Third Order Intercept, TOI		24		dBm
Noise Figure, NF		7		dB
Gain Temperature Coefficient		-0.04		dB/ $^\circ\text{C}$
Power Temperature Coefficient		-0.0025		dB/ $^\circ\text{C}$

Notes: 1.

Specifications

Thermal and Reliability Information

Parameter	Conditions	Rating
Thermal Resistance, θ_{JC} , measured to back of package	Tbase = 85 °C	$\theta_{JC} = 81 \text{ } ^\circ\text{C/W}$
Channel Temperature (Tch), and Median Lifetime (Tm)	Tbase = 85 °C Vd = 7 V, Id = 85 mA Pdiss = 0.6 W	Tch = 134 °C Tm = 4.1E+6 Hours
Channel Temperature (Tch), and Median Lifetime (Tm) Under RF Drive	Tbase = 85 °C Vd = 7 V, Id = 85 mA Pdiss = 0.6 W	Tch = 134 °C Tm = 4.1E+6 Hours

Median Lifetime vs. Channel Temperature

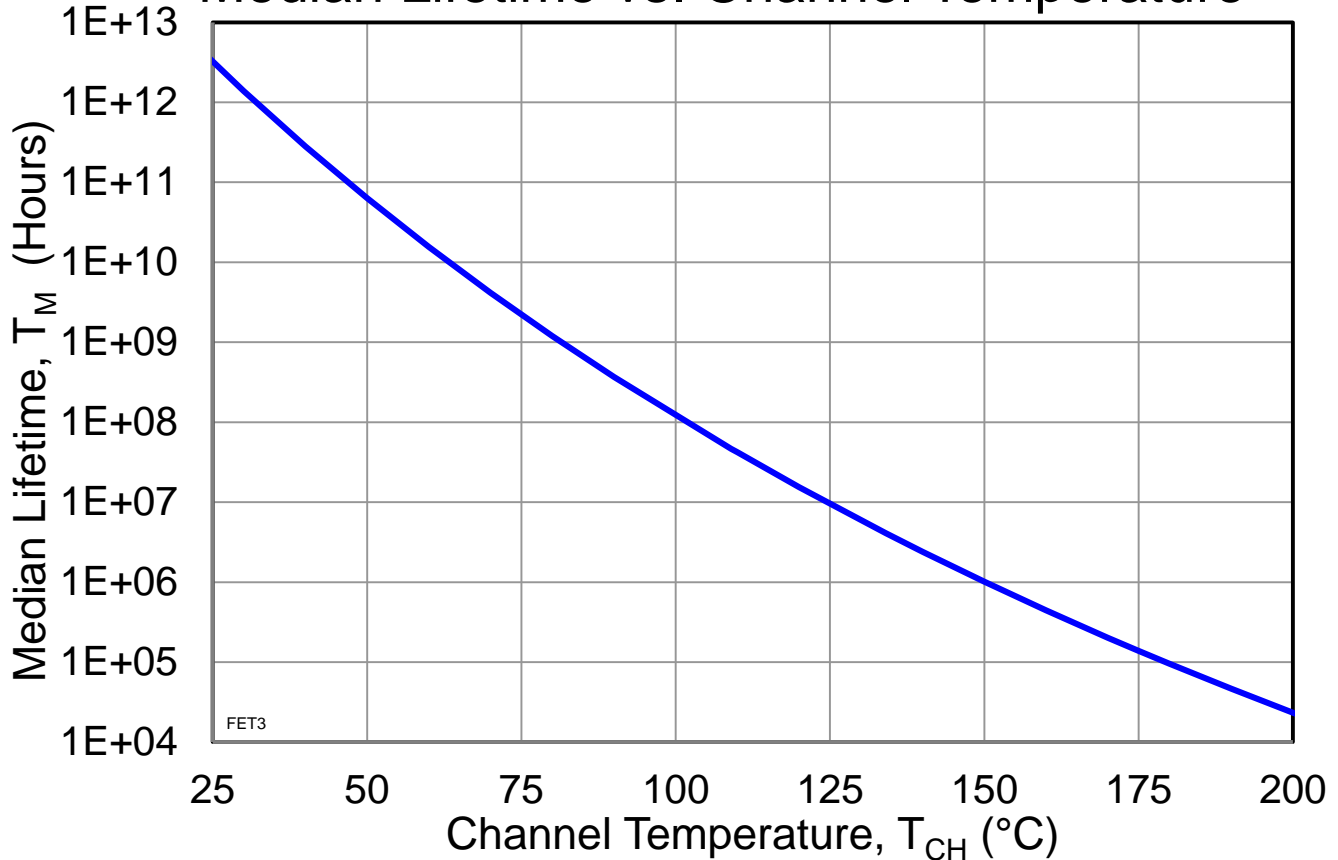

Typical Performance

S-Parameters vs. Frequency
 Vd = 7 V, Id = 85 mA Self Bias, +25°C

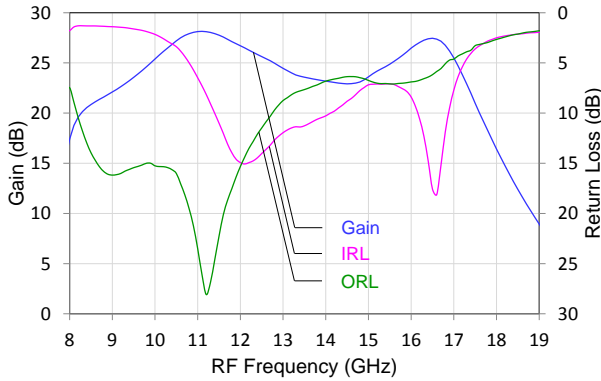

S-Parameters vs. Frequency
 Vd = 7 V, Id = 85 mA Self Bias, +25°C

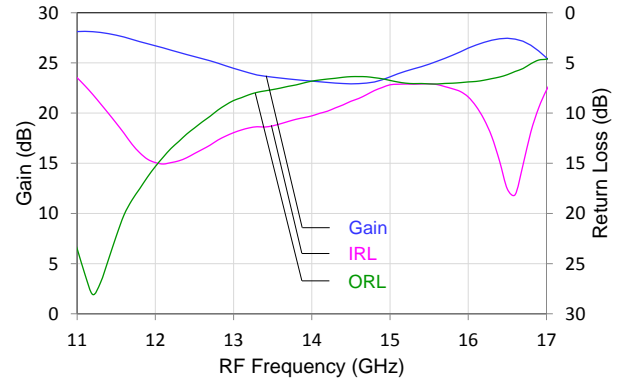

Output Power vs. Frequency
 Vd = 7 V, Id = 85 mA Self Bias, +25°C

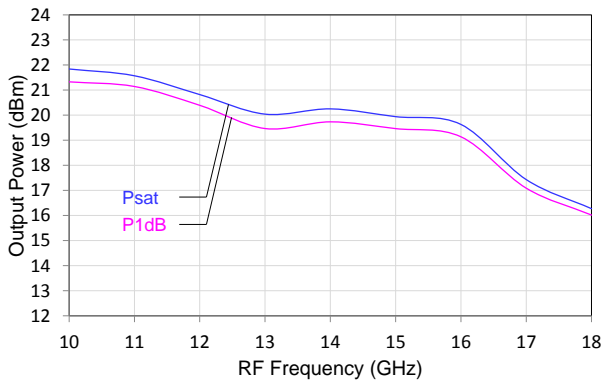

Pout, Gain, Id vs. Pin @ 14 GHz
 Vd = 7 V, Id = 85 mA Self Bias, +25°C

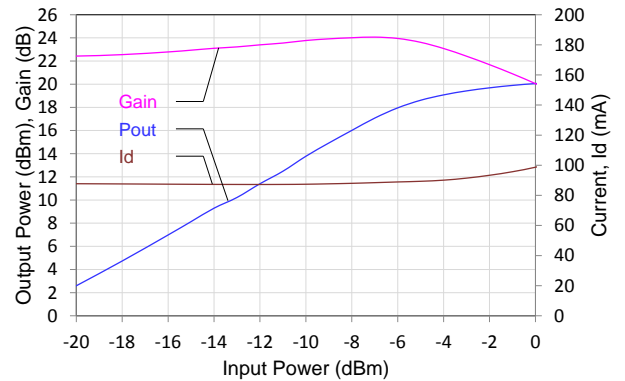

TOI vs. Frequency vs. Pout/Tone
 Vd = 7 V, Id = 85 mA Self Bias, +25°C

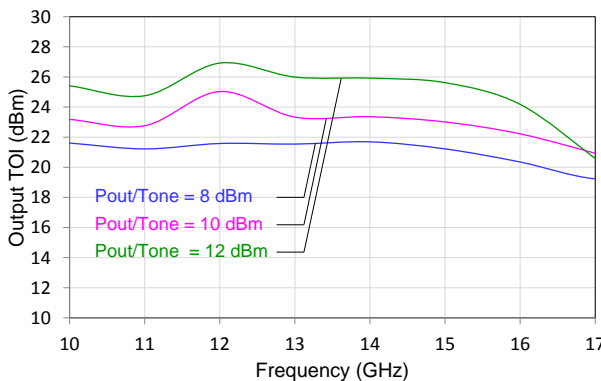

IM3 vs. Pout/Tone vs. Frequency
 Vd = 7 V, Id = 85 mA Self Bias, +25°C

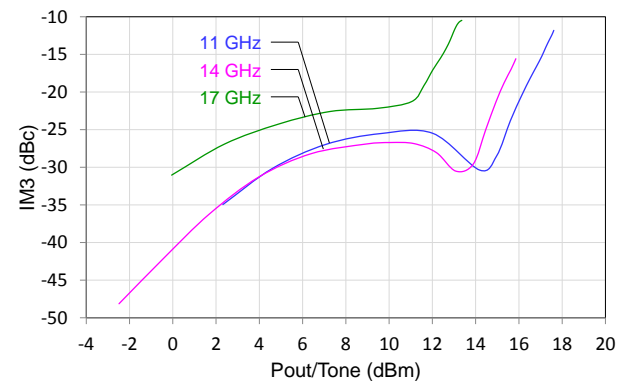

Typical Performance

IM5 vs. Pout/Tone vs. Frequency
 Vd = 7 V, Id = 85 mA Self Bias, +25°C

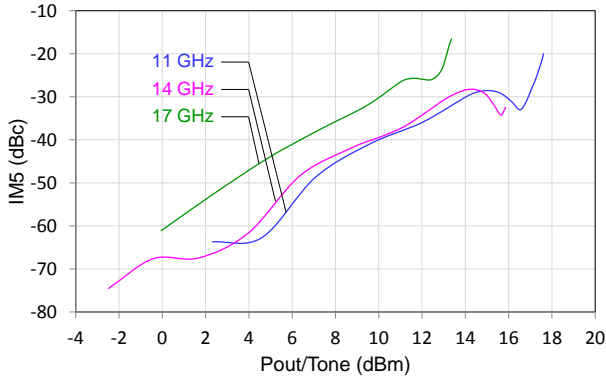

Noise Figure vs. Frequency
 Vd = 7 V, Id = 85 mA Self Bias, +25°C

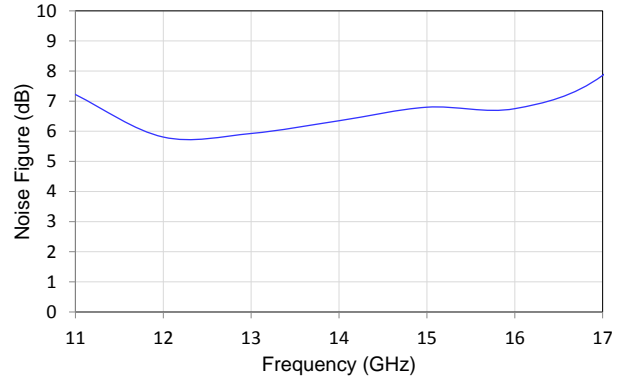

Gain vs. Frequency vs. Vd
 Vd = 6 - 9 V, Id = 85 mA Self Bias, +25°C

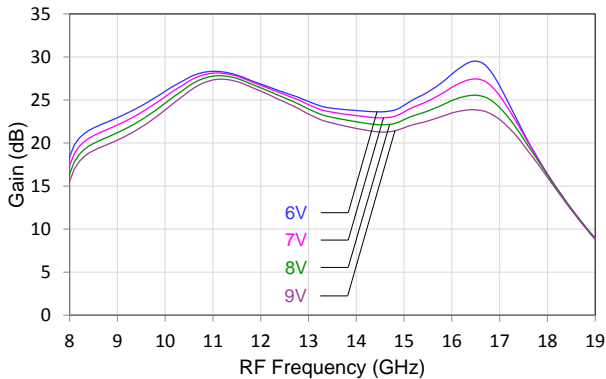

Psat vs. Frequency vs. Vd
 Vd = 6 - 9 V, Id = 85 mA Self Bias, +25°C

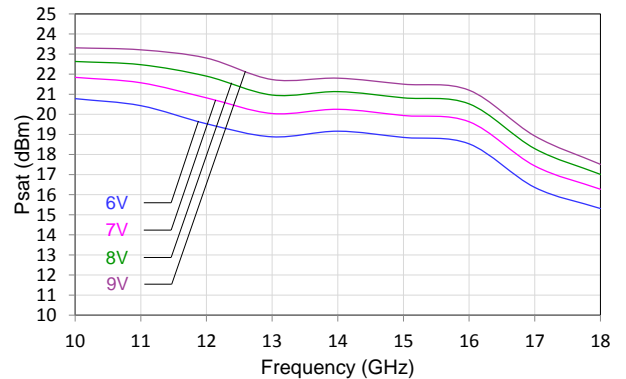

P1dB vs. Frequency vs. Vd
 Vd = 6 - 9 V, Id = 85 mA Self Bias, +25°C

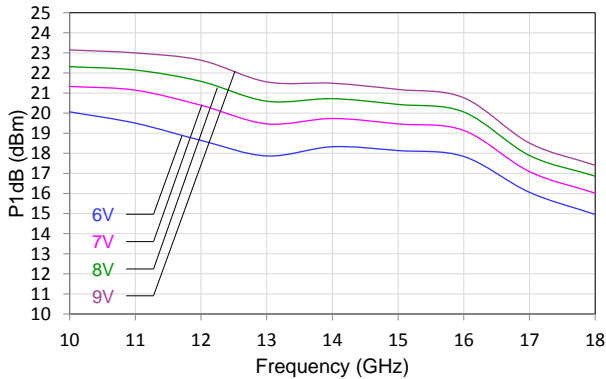

TOI vs. Frequency vs. Vd
 Vd = 6 - 9 V, Id = 85 mA Self Bias, +25°C

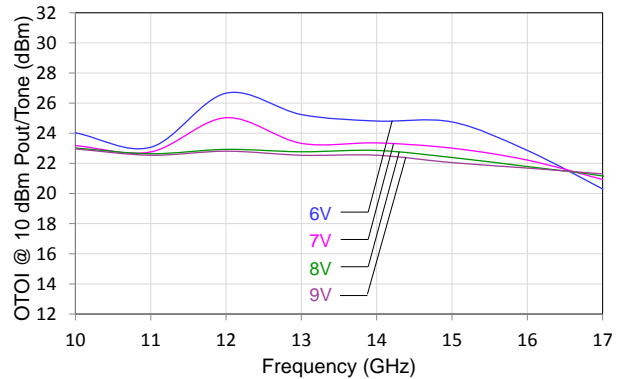

Typical Performance

Noise Figure vs. Frequency vs. Vd
 Vd = 6 - 9 V, Id = 85 mA Self Bias, +25°C

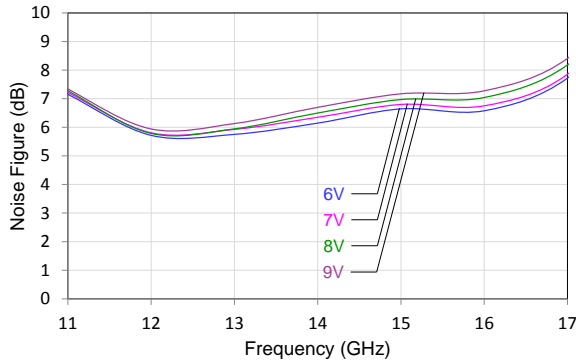

Gain vs. Frequency vs. Temperature
 Vd = 7 V, Id = 85 mA Self Bias

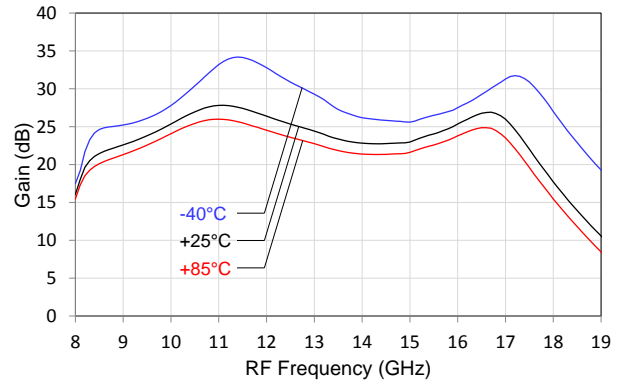

Psat vs. Frequency vs. Temperature
 Vd = 7 V, Id = 85 mA Self Bias

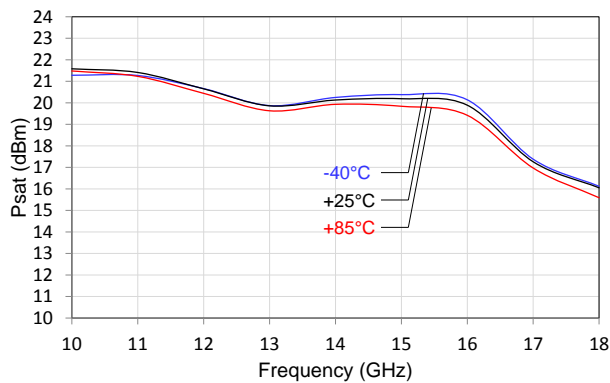

Noise Figure vs. Frequency vs. Temperature
 Vd = 7 V, Id = 85 mA Self Bias

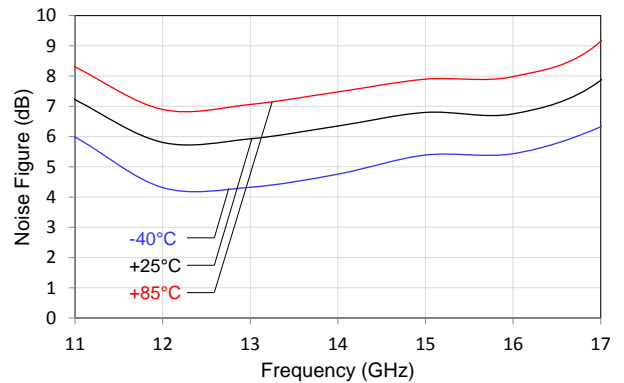

Pin Configuration and Description

Top View

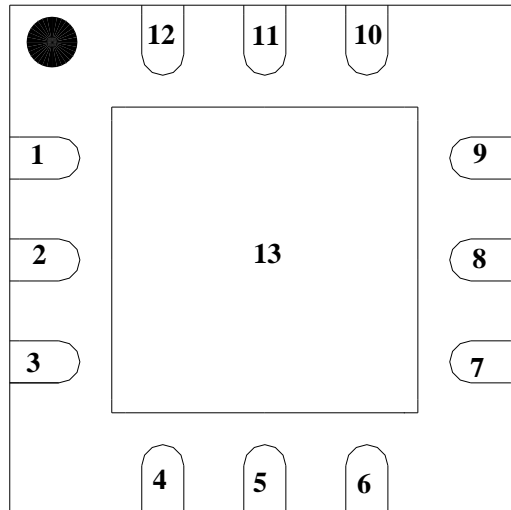

Pin No.	Label	Description
1, 3, 4, 6, 7, 9, 10, 11, 12	NC	No internal connection; must be grounded on PCB.
2	RF IN	RF Input, matched to 50 ohms, AC Coupled.
5	Vd	Drain voltage. Bias network is required; see Application Circuit on page 8 as an example.
8	RF OUT	RF Output, matched to 50 ohms, AC Coupled.
13	GND	Backside Paddle. Multiple vias should be employed to minimize inductance and thermal resistance; see Mounting Configuration on page 15 for suggested footprint.

Application Circuit

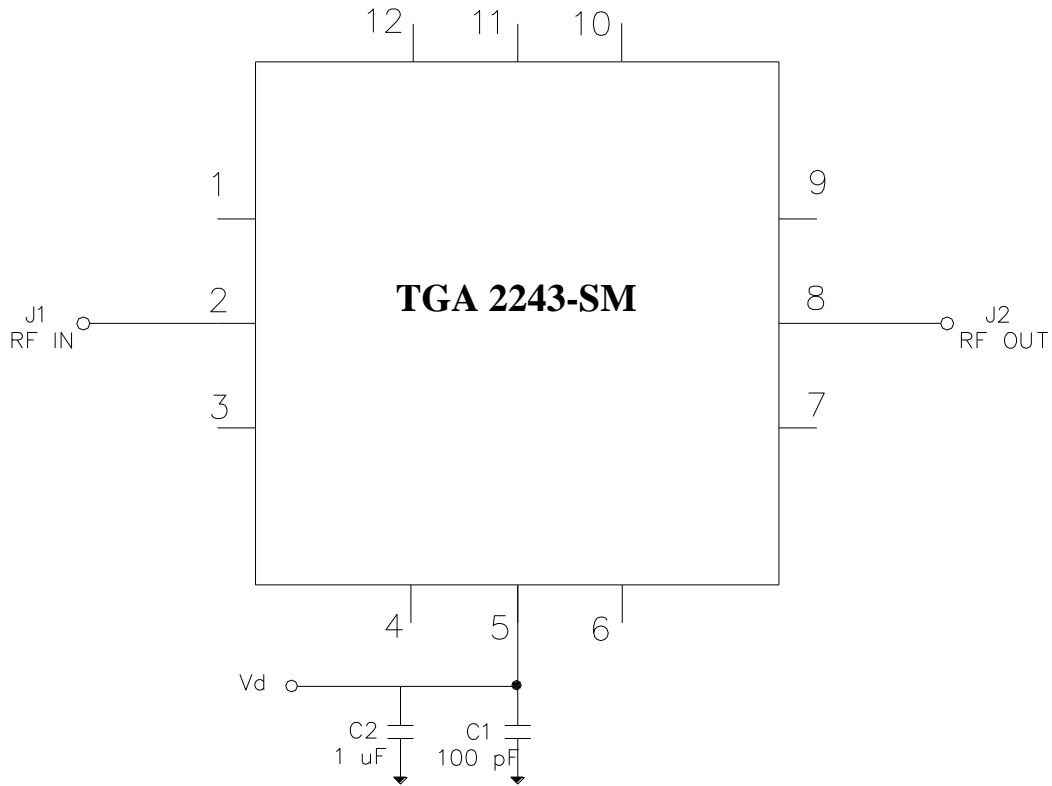

Bias-up Procedure	Bias-down Procedure
Vd set to +7 V	Turn off RF signal
Id is 85 mA, self-bias	Turn Vd to 0 V
Apply RF signal	

Application Circuit

PC Board Layout

Board material is RO4003 0.008" thickness with ½ oz copper cladding.
 For further technical information, refer to the [TGA2243-SM](#) Product Information page.

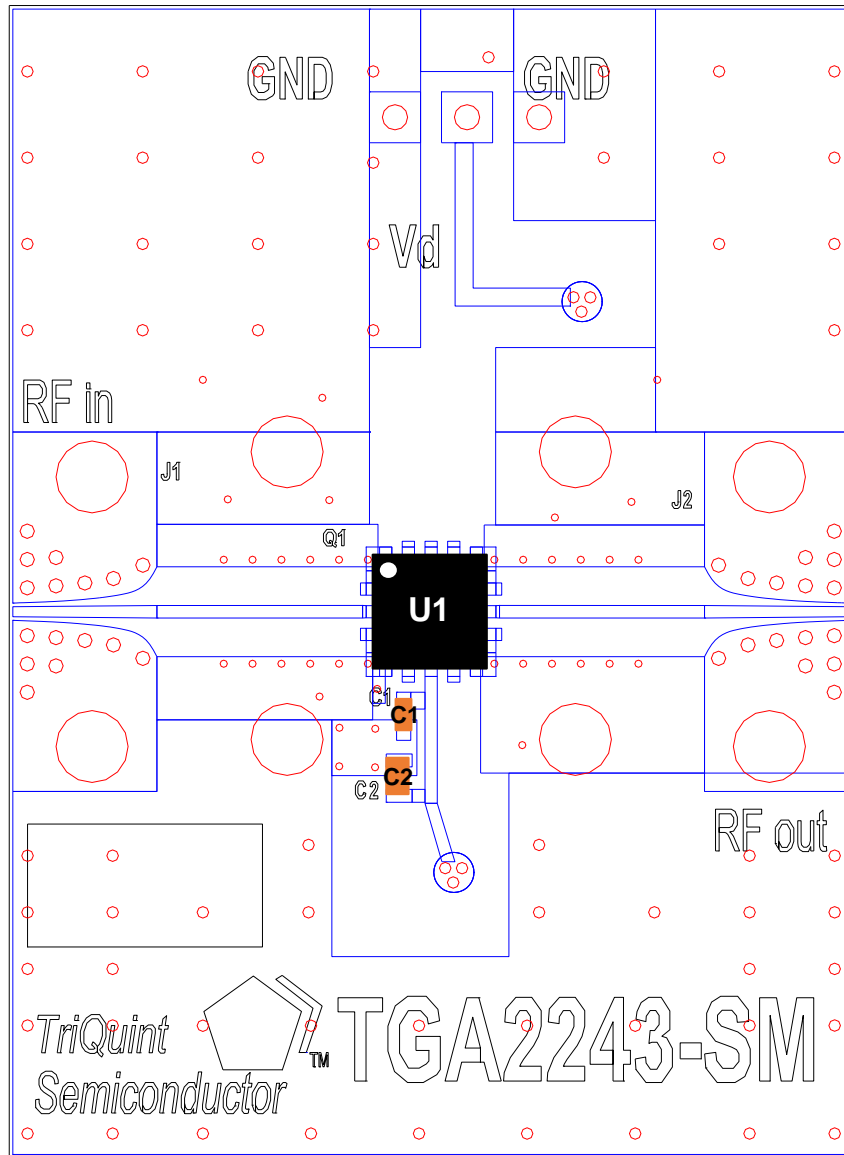

Bill of Material

Ref Des	Value	Description	Manufacturer	Part Number
C1	100 pF	Cap, 0402, 50V, 5%, NPO	various	
C2	0.01 µF	Cap, 0603, 25V, 5%, COG	various	
U1		Ku-Band Driver Amplifier	Triquint	TGA2243-SM

Mechanical Information

Package Marking and Dimensions

All dimensions are in millimeters.

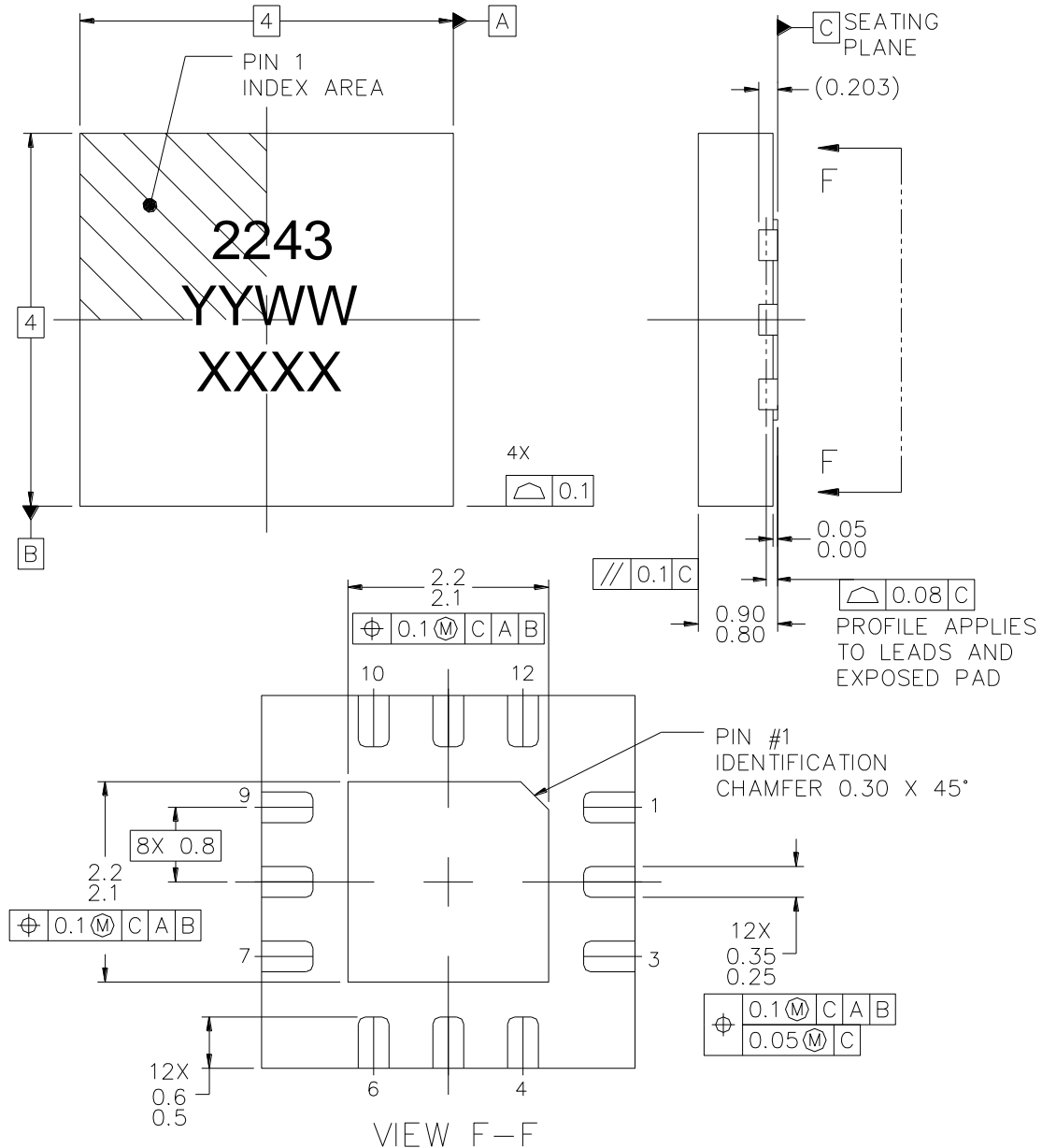

The TGA2243-SM will be marked with the “2243” designator and a lot code marked below the part designator. The “YY” represents the last two digits of the year the part was manufactured, the “WW” is the work week, and the “XXXX” is an auto-generated number.

This package is lead-free/RoHS-compliant with a copper alloy base (CDA194), and the plating material on the leads is NiPdAu. It is compatible with lead-free (maximum 260 °C reflow temperature) soldering process.

Mechanical Information

PCB Mounting Patter

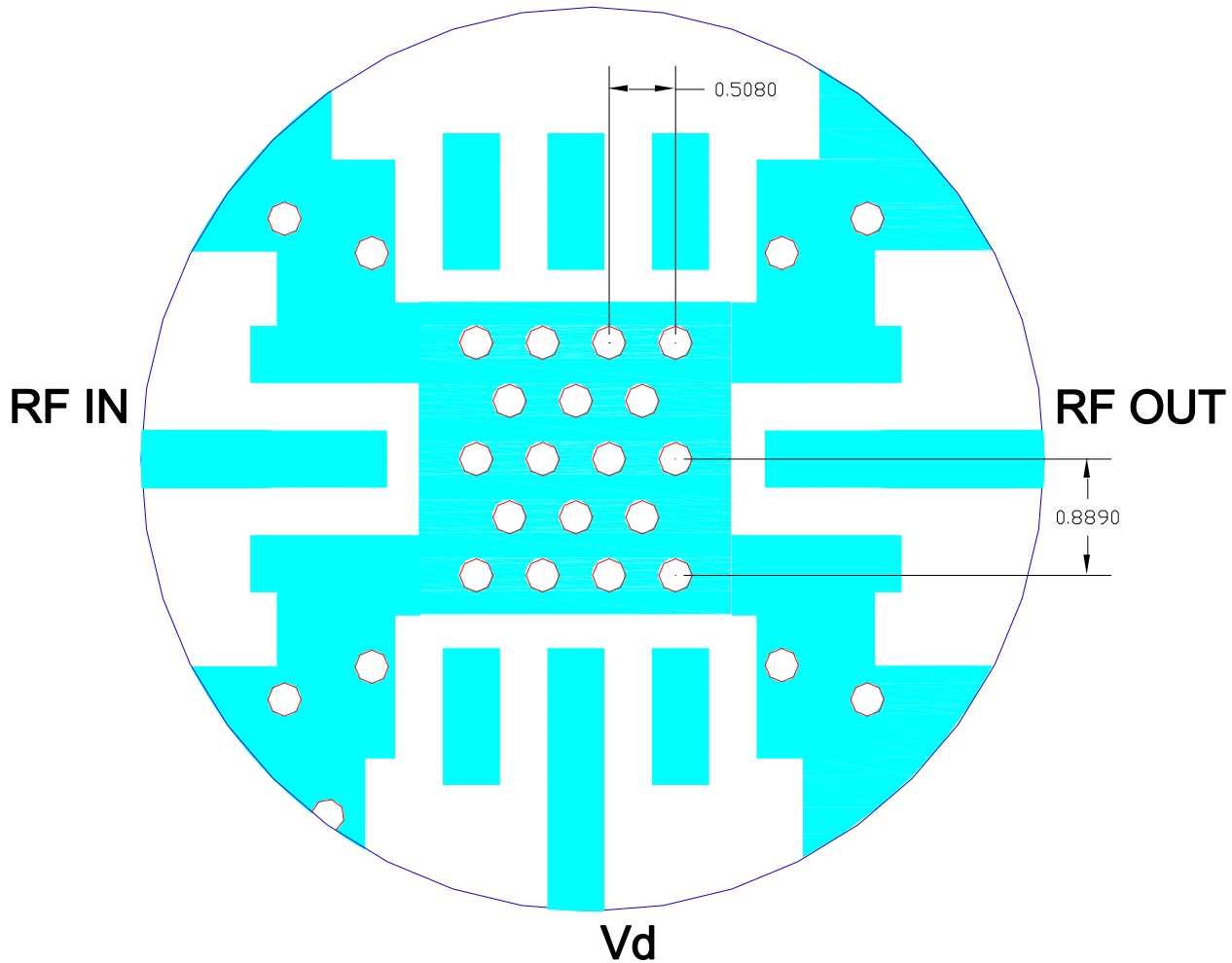

Notes:

1. The pad pattern shown has been developed and tested for optimized assembly at TriQuint Semiconductor. The PCB land pattern has been developed to accommodate lead and package tolerances. Since surface mount processes vary from company to company, careful process development is recommended.
2. Ground vias are critical for the proper performance of this device. Vias should use a .35mm (#80 / .0135") diameter drill and have a final plated thru diameter of .25 mm (.010").

Tape and Reel Information

Standard T/R size = 500 pieces on a 7" reel.

Material		Cavity (mm)				Distance Between Centerline (mm)		Carrier Tape (mm)	Cover Carrier (mm)
Vendor	Vendor P/N	Length (A0)	Width (B0)	Depth (K0)	Pitch (P1)	Length direction (P2)	Width Direction (F)	Width (W)	Width (W)
Tek-Pak	QFN0500X0 500F-L500	5.3	5.3	1.65	8.0	2.00	5.50	12.0	9.20

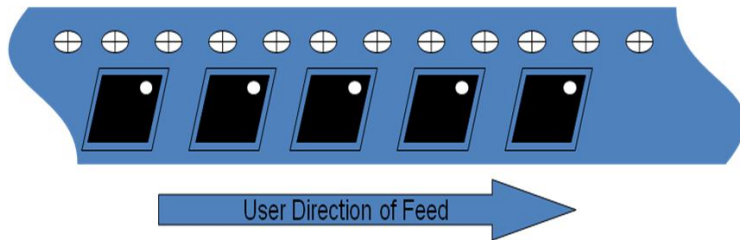
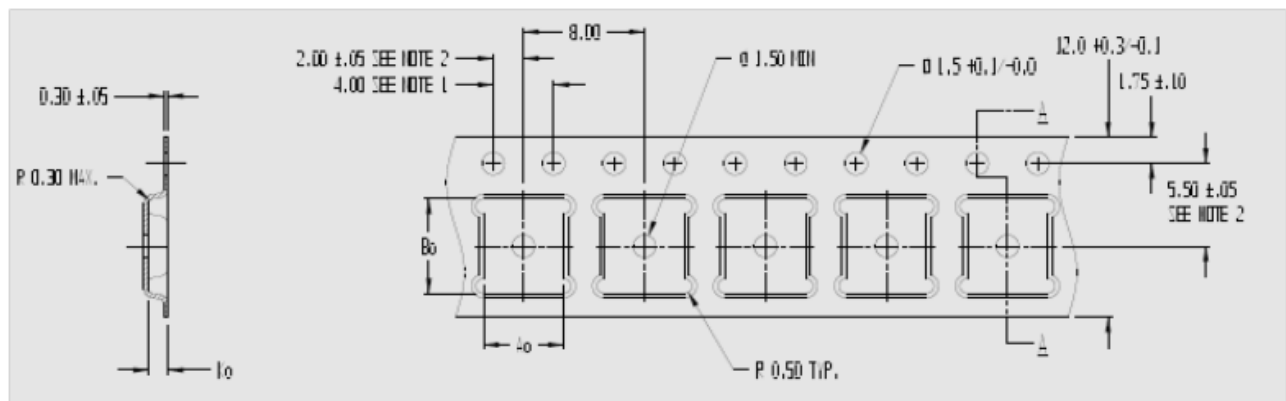

Product Compliance Information

ESD Sensitivity Ratings



Caution! ESD-Sensitive Device

ESD Rating: TBD
 Value: TBD
 Test: Human Body Model (HBM)
 Charge Device Model (CDM)
 Standard: JEDEC Standard JESD22-A114

MSL Rating

MSL Rating: Level 3
 Test: 260°C convection reflow
 Standard: JEDEC Standard IPC/JEDEC J-STD-020

Solderability

Compatible with lead-free soldering processes,
 260 °C maximum reflow temperature.

Package lead plating: NiAu.

RoHS Compliance

This part is compliant with EU 2002/95/EC RoHS directive (Restrictions on the Use of Certain Hazardous Substances in Electrical and Electronic Equipment).

This product also has the following attributes:

- Lead Free
- Halogen Free (Chlorine, Bromine)
- Antimony Free
- TBBP-A (C₁₅H₁₂Br₄O₂) Free
- PFOS Free
- SVHC Free

Recommended Solder Temperature Profile

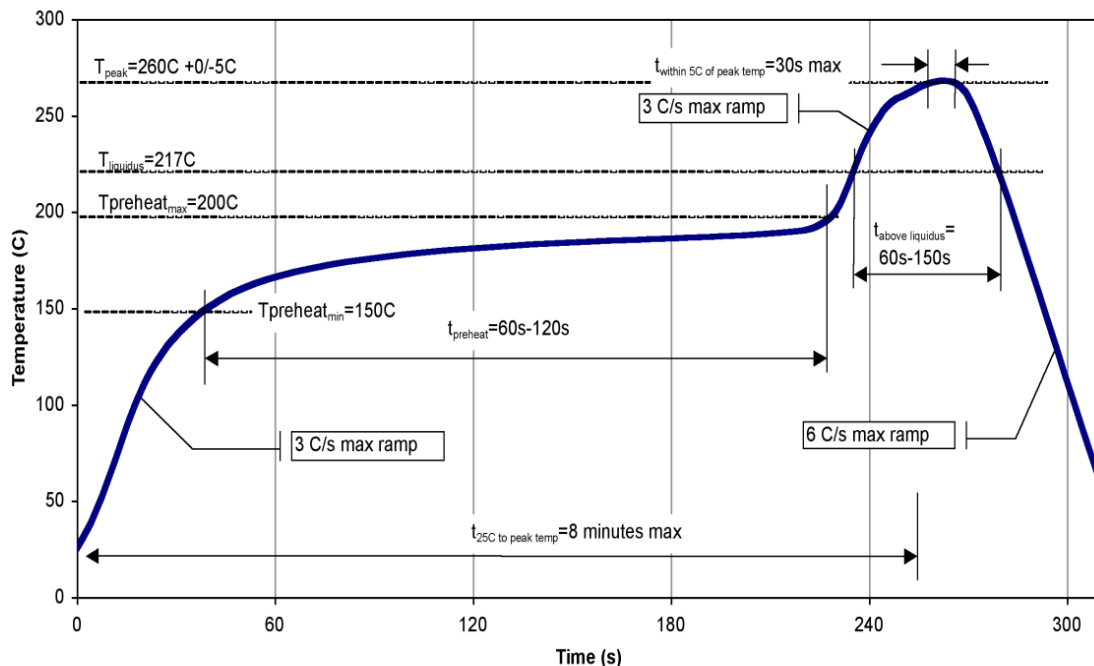

Contact Information

For the latest specifications, additional product information, worldwide sales and distribution locations, and information about TriQuint:

Web: www.triquint.com
Email: info-sales@tqs.com

Tel: +1.972.994.8465
Fax: +1.972.994.8504

For technical questions and application information: **Email:** info-networks@tqs.com

Important Notice

The information contained herein is believed to be reliable. TriQuint makes no warranties regarding the information contained herein. TriQuint assumes no responsibility or liability whatsoever for any of the information contained herein. TriQuint assumes no responsibility or liability whatsoever for the use of the information contained herein. The information contained herein is provided "AS IS, WHERE IS" and with all faults, and the entire risk associated with such information is entirely with the user. All information contained herein is subject to change without notice. Customers should obtain and verify the latest relevant information before placing orders for TriQuint products. The information contained herein or any use of such information does not grant, explicitly or implicitly, to any party any patent rights, licenses, or any other intellectual property rights, whether with regard to such information itself or anything described by such information.

TriQuint products are not warranted or authorized for use as critical components in medical, life-saving, or life-sustaining applications, or other applications where a failure would reasonably be expected to cause severe personal injury or death.