

Applications

- Commercial and Military Radar
- Communications
- Test Instrumentation



Product Features

- Frequency Range: 2.7 - 4.0 GHz
- Small Signal Gain: > 24 dB
- Power: > 30.7 dBm
- PAE: > 22 %
- IM3: < -32 dBc (@ 3.5 GHz)
- Input Return Loss > 7 dB
- Output Return Loss > 11 dB
- Self-Bias: $V_D = 6\text{ V}$, $V_G = 0\text{ V}$, $I_{DQ} = 900\text{ mA}$
- Single Supply Operation
- Package Dimensions: 5.0 x 5.0 x 0.85 mm

Functional Block Diagram

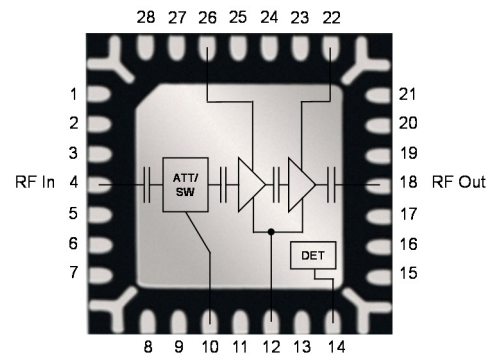

General Description

TriQuint's TGA2731-SM is a driver amplifier fabricated on TriQuint's TQPHT25 0.25um GaAs production process. The TGA2731-SM operates from 2.7 to 4.0 GHz and provides > 30.7 dBm of output power with > 22.7 dB of large signal gain. The TGA2731-SM also includes a 13dB attenuator at the input, and a simple resistively coupled power detector at the output. The amplifier can be operated from a single supply in the self-biased mode.

The TGA2731-SM is offered in a 5x5 mm plastic QFN. It is well-matched to 50 ohms, and includes integrated DC blocking caps on both RF ports allowing for simple system integration.

Lead-Free & RoHS compliant.

Evaluation Boards are available on request.

Pad Configuration

Pad Number	Symbol
1-3, 5-9, 11 13, 15-17, 19-21, 23-25, 27-28	No Connect
4	RF Input
10	V_{SW}
12	V_G
14	Power Sample
18	RF Output
22	V_{D2}
26	V_{D1}
29	GND

Ordering Information

Part	ECCN	Description
TGA2731-SM	EAR99	2.7 – 4.0 GHz Driver Amplifier

Absolute Maximum Ratings

Parameter	Value
Drain Voltage (V_D)	9
Gate Voltage Limits (V_G)	-1 V / 0V
Drain Current (I_D)	1000 mA
Gate Current ($+I_G$ @ $T_{CH} = 150$ °C)	-5.28 / 24.8 mA
Power Dissipation, $T_{BASE} = 85$ °C, $T_{CH} = 200$ °C, CW operation (P_{diss})	4.50 W
Input Power, CW, 50Ω ¹	13 dBm
Input Power, CW, VSWR 10:1 ¹	13 dBm
Channel Temperature (T_{CH})	200 °C

Notes:

1. $V_D = 6$ V, $V_G = 0$ V, $T_{BASE} = 85$ °C

Recommended Operating Conditions

Parameter	Value
Drain Voltage (V_D)	6 V
Gate Voltage (V_G) (self-biased mode)	0 V
Quiescent Drain Current (I_{DQ})	900 mA
Operating Drain Current (I_{D_DRIVE})	800-975 mA

Electrical Specifications

Test conditions, unless otherwise noted: $T = 25$ °C, $V_D = 6$ V, $V_G = 0$ V / $I_{DQ} \sim 900$ mA, $V_{SW} = 0$ V, part mounted to EVB
 Output Power and PAE pulse conditions: $PW = 100$ us, $DC = 20\%$

Parameter	Min	Typical	Max	Units
Operating Frequency Range	2.7		4.0	GHz
Output Power (Pulsed, $P_{in} = 8$ dBm)		> 30.7		dBm
Power Added Efficiency (Pulsed, $P_{in} = 8$ dBm)		> 22		%
Small Signal Gain		> 24		dB
Input Return Loss		> 7		dB
Output Return Loss		> 11		dB
IM3 ($P_{OUT}/\text{tone} \leq 23$ dBm, 3.5 GHz)		< -32		dBc
2 nd Harm. Suppression ($P_{OUT} \leq 30$ dBm, 3.5 GHz)		< -39		dBc
3 rd Harm. Suppression ($P_{OUT} \leq 30$ dBm, 3.5 GHz)		< -44		dBc
Output Power Temperature Coefficient		-0.004		dB/°C

Specifications

Thermal and Reliability Information

Parameter	Conditions	Value	Units
Thermal Resistance (θ_{JC}) ⁽¹⁾	$T_{BASE} = 85^\circ\text{C}$, $V_D = 6\text{ V}$, $V_G = 0\text{ V}$, $I_{D_DRIVE} = 800\text{ mA}$, Pulse Power Conditions: Pulse Width = 100 μs , Duty Cycle = 10%, $P_{IN} = 0\text{ dBm}$, $P_{OUT} = 27\text{ dBm}$, $P_{DISS(PULSE)} = 4.75\text{ W}$	11.6	$^\circ\text{C/W}$
Channel Temperature (T_{CH}) ⁽¹⁾		140	$^\circ\text{C}$
Median Lifetime (T_M)		2.4E06	Hrs

Note:

1. Package backside temperature fixed at 85 $^\circ\text{C}$.

Median Lifetime

Test Conditions: 10 V; Failure Criterion = 10% reduction in I_{D_MAX}

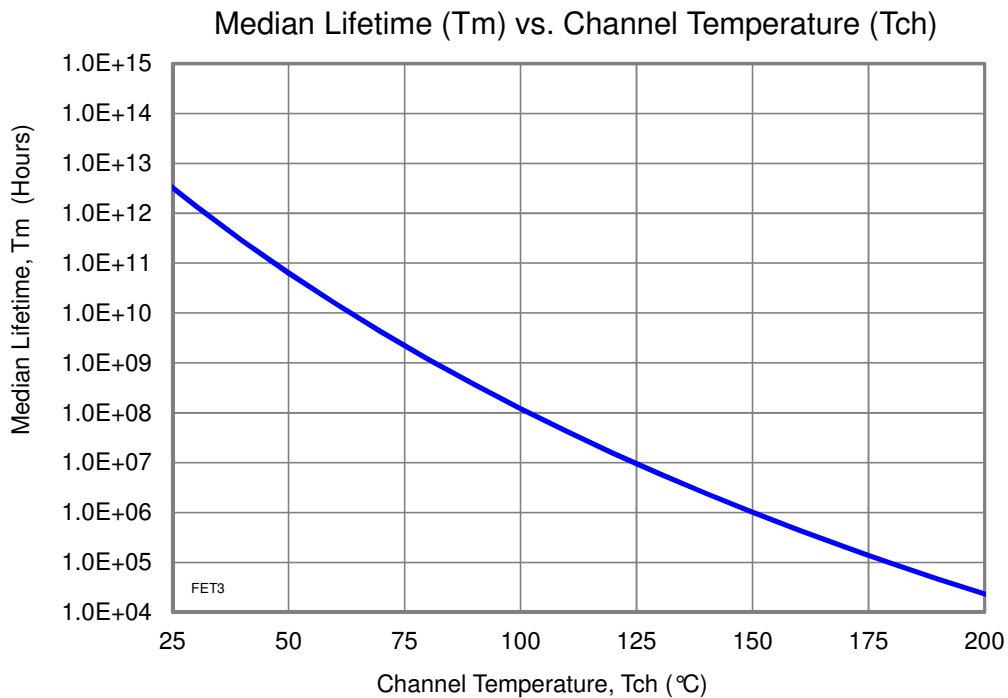

Typical Performance – Small Signal

Test conditions, unless otherwise noted: T = 25 °C, part mounted to EVB

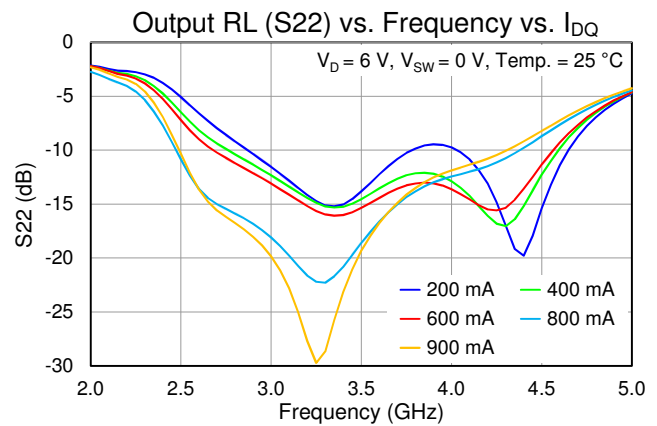
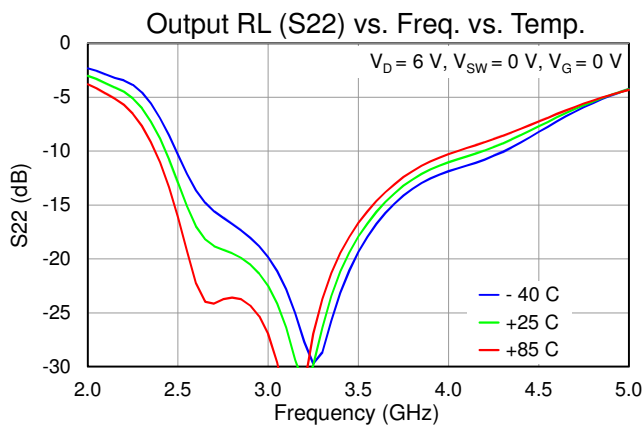
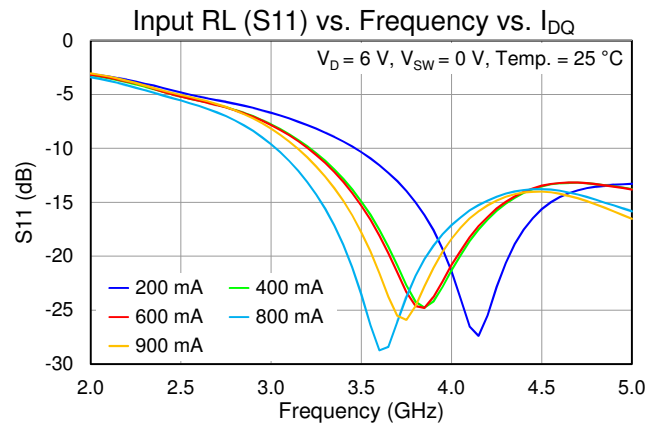
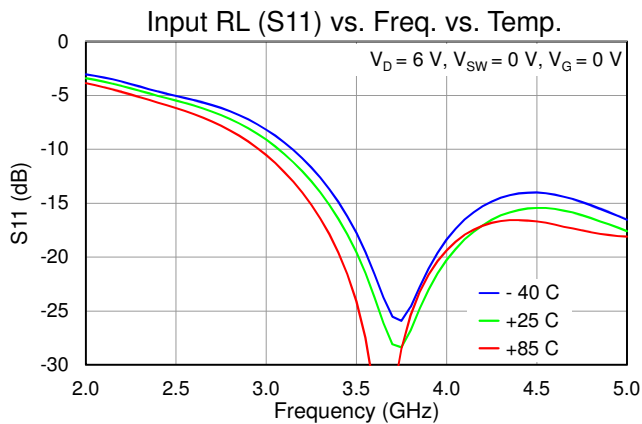
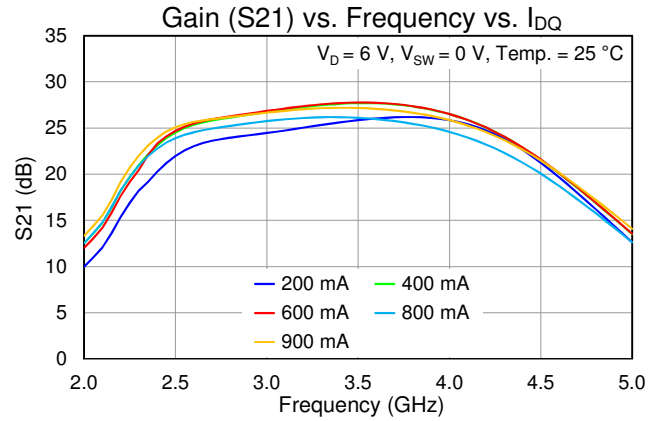
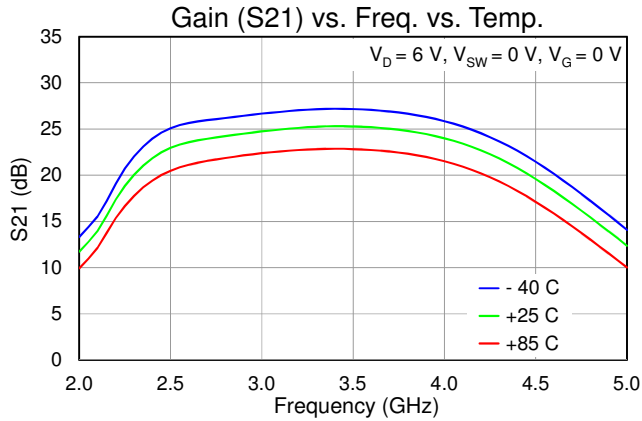

Typical Performance – Small Signal

Test conditions, unless otherwise noted: T = 25 °C, part mounted to EVB

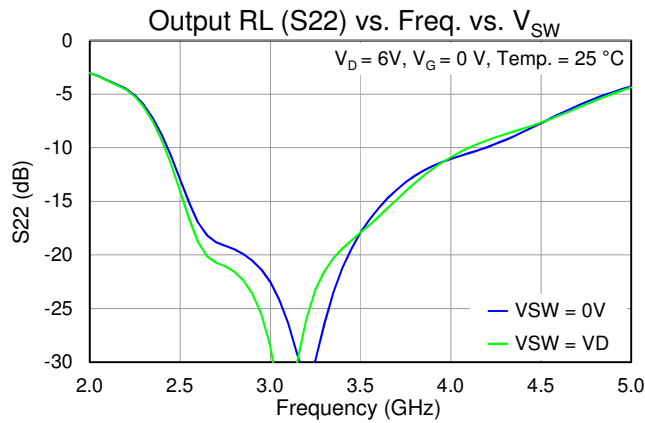
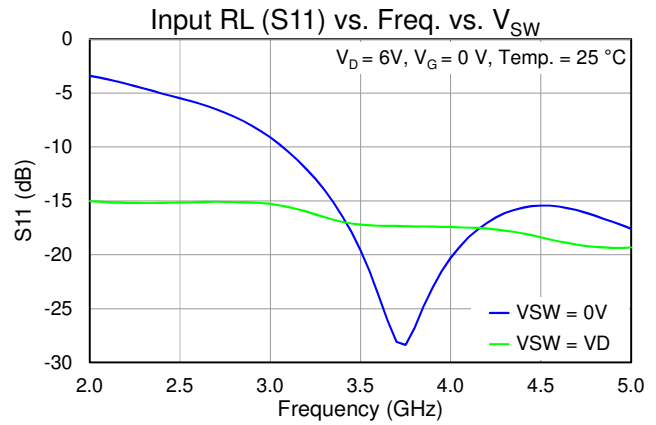
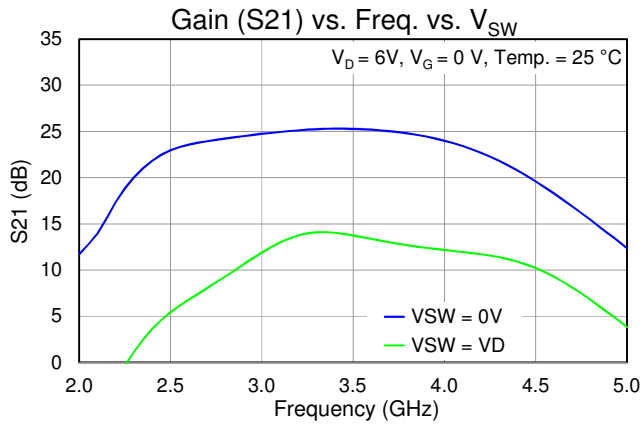

Typical Performance – Large Signal (Pulsed)

Test conditions, unless otherwise noted: T = 25 °C, part mounted to EVB, Pulse Power: PW = 100 us, DC = 20%

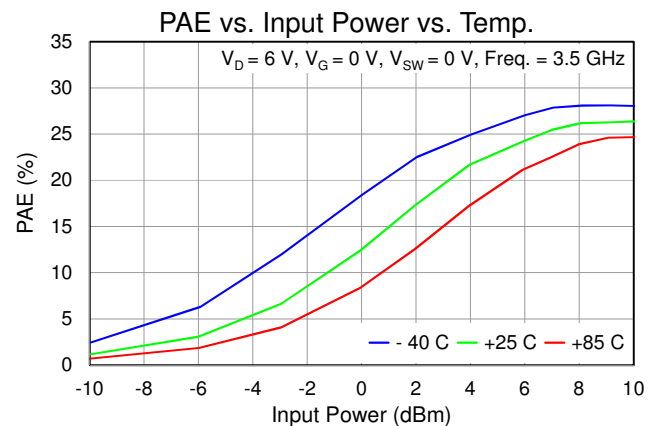
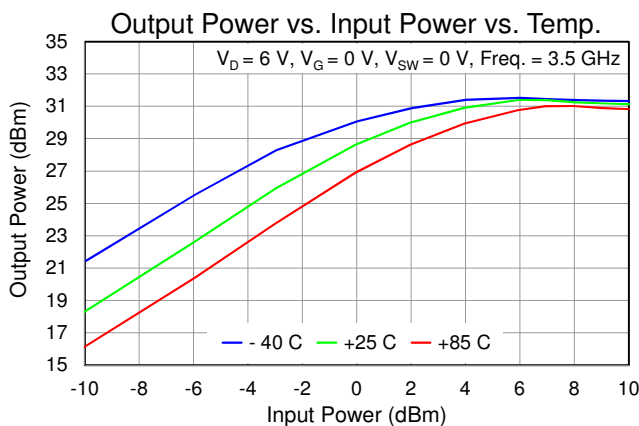
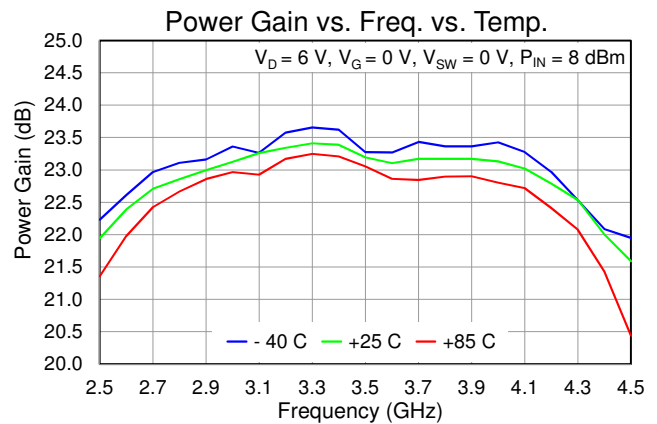
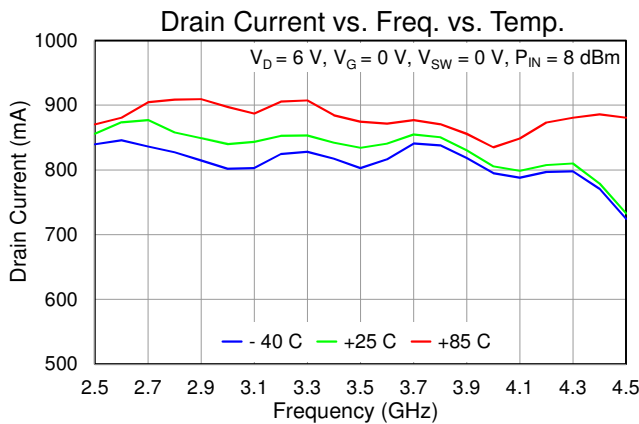
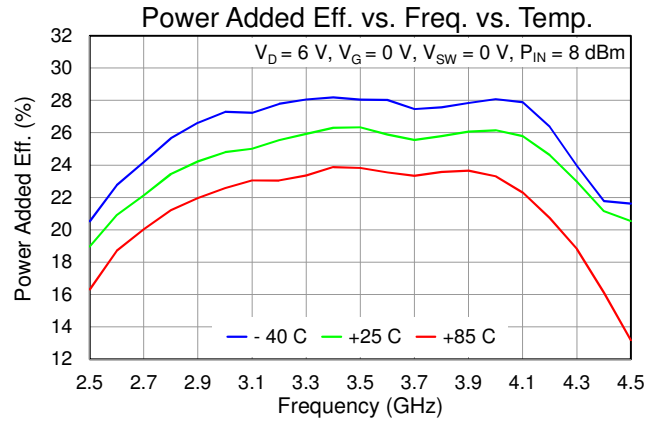
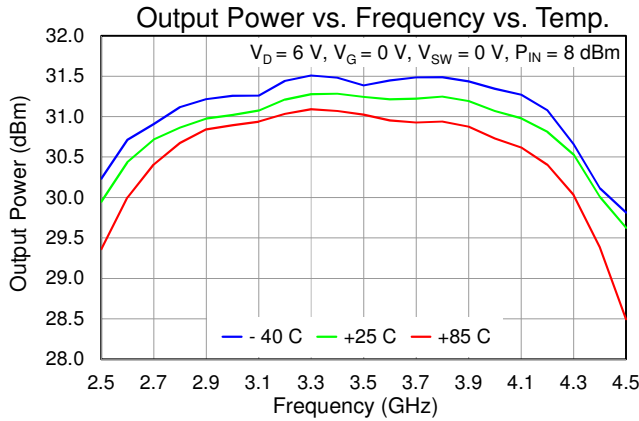

Typical Performance – Large Signal (Pulsed)

Test conditions, unless otherwise noted: T = 25 °C, part mounted to EVB, Pulse Power: PW = 100 us, DC = 20%

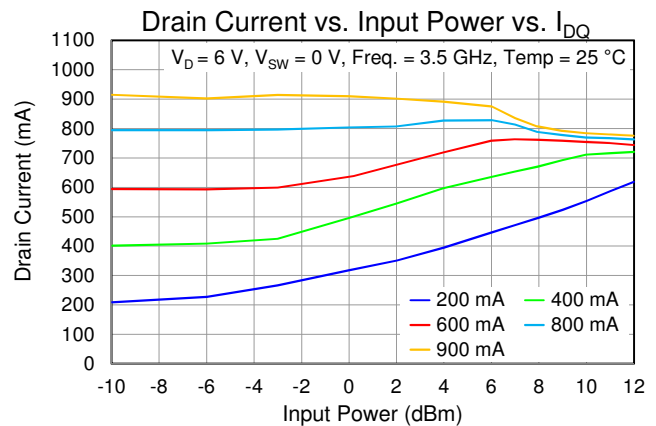
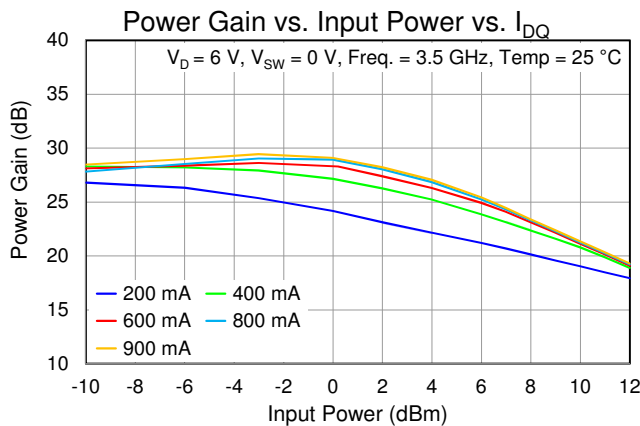
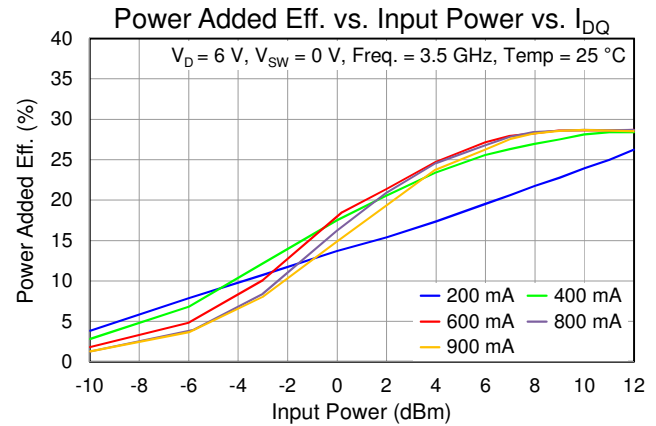
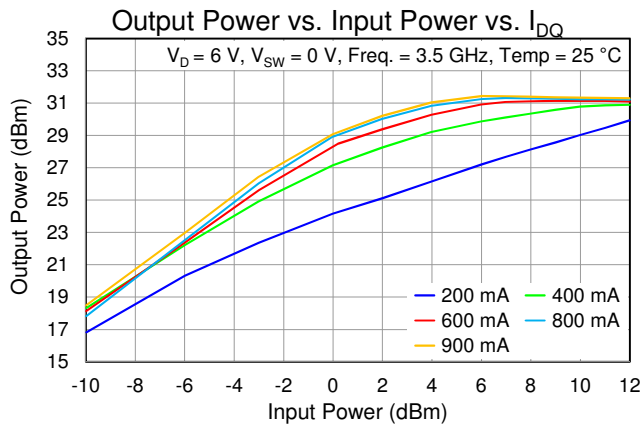
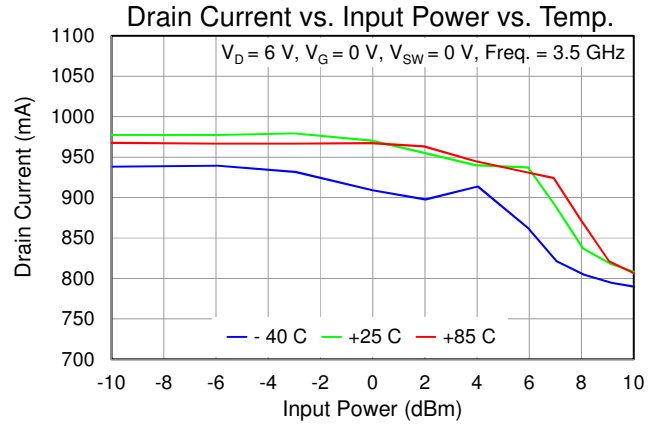
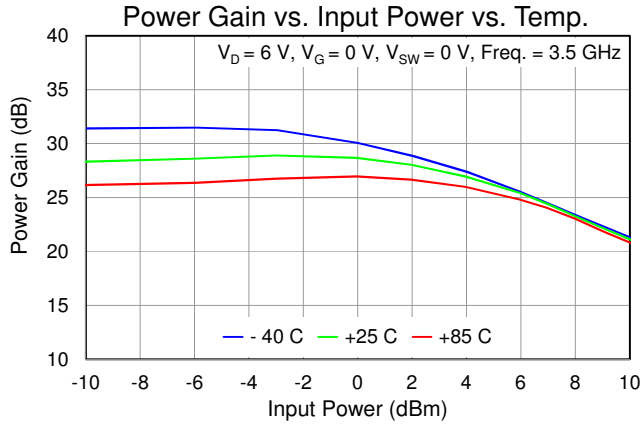

Typical Performance - Linearity

Test conditions, unless otherwise noted: T = 25 °C, V_{SW} = 0 V, part mounted to EVB

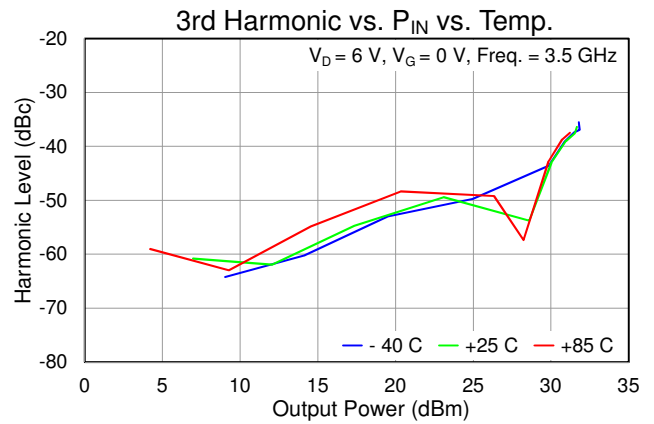
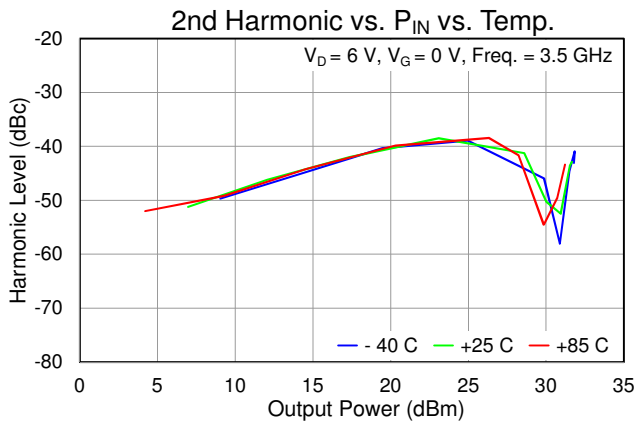
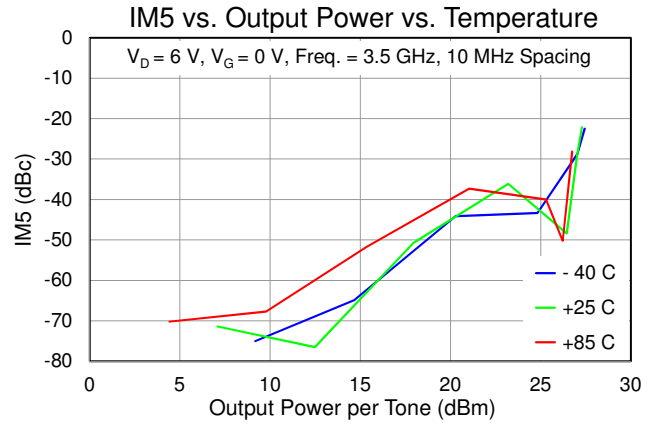
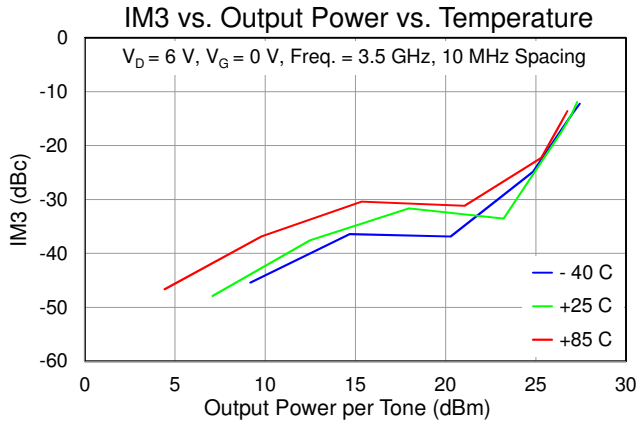

Application Circuit

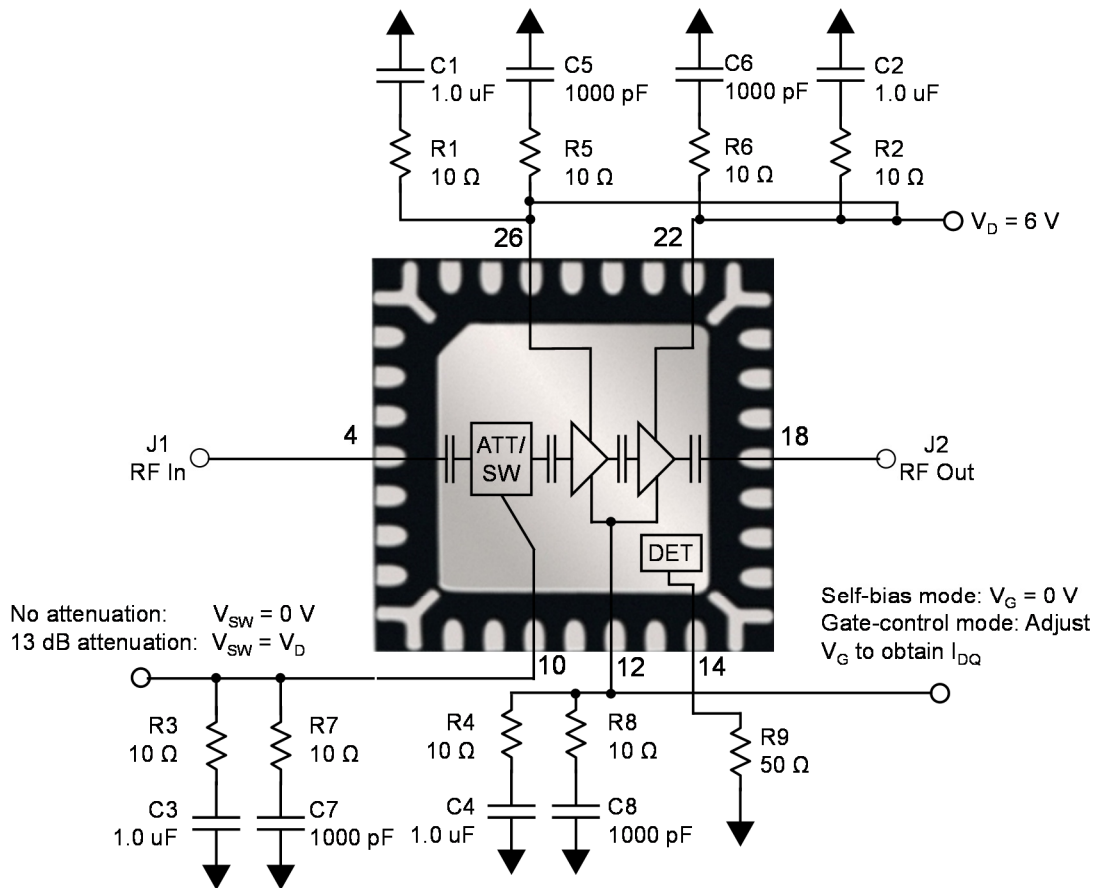

Bias-up Procedure

1. Set I_D limit to 1000 mA, I_G limit to 12 mA
2. Self-biased mode: Set V_G to 0 V
Gate-control mode: Adjust V_G to obtain desired I_{DQ}
3. Increase V_D to +6 V
4. Apply RF signal

Bias-down Procedure

1. Turn off RF signal
2. Set V_D to 0 V. Ensure $I_{DQ} \sim 0$ mA
3. Turn off V_D supply
4. Turn off V_G , V_{SW} supply

Applications Information

Evaluation Board Layout

RF Layer is 0.008" thick Rogers Corp. RO4003C, $\epsilon_r = 3.38$. Metal layers are 0.5 oz. copper. The microstrip line at the connector interface is optimized for the Southwest Microwave end launch connector 1092-01A-5.

The pad pattern shown has been developed and tested for optimized assembly at TriQuint Semiconductor. The PCB land pattern has been developed to accommodate lead and package tolerances. Since surface mount processes vary from company to company, careful process development is recommended.

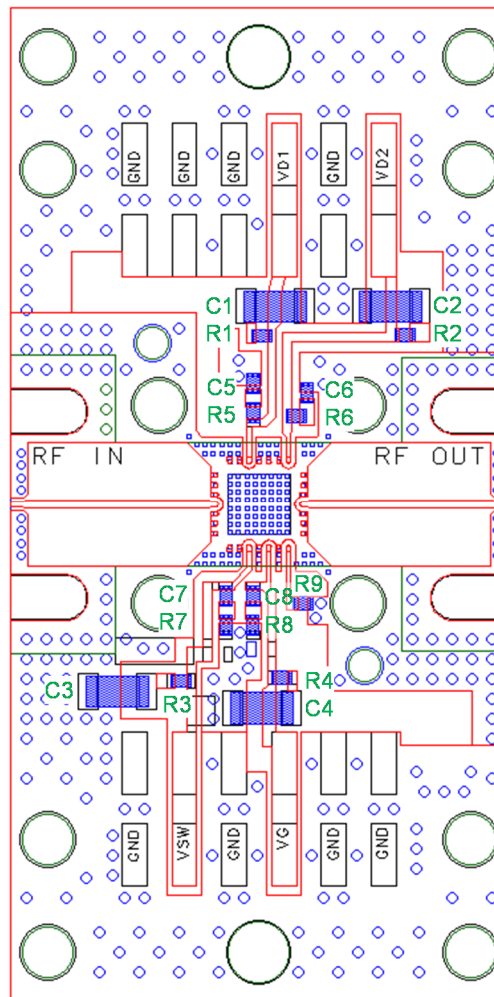

Bill of Materials

Ref. Designation	Value	Description	Manufacturer	Part Number
C1 – C4	1.0 uF	Cap., 50V, 10% X5R, 1206 case	Various	
C5 – C8	1000 pF	Cap., 50V, 10% X7R, 0402 case	Various	
R1 – R8	10 Ohms	Resistor, 0402 case	Various	
R9	50 Ohms	Resistor, 0402 case	Various	

Mounting Detail

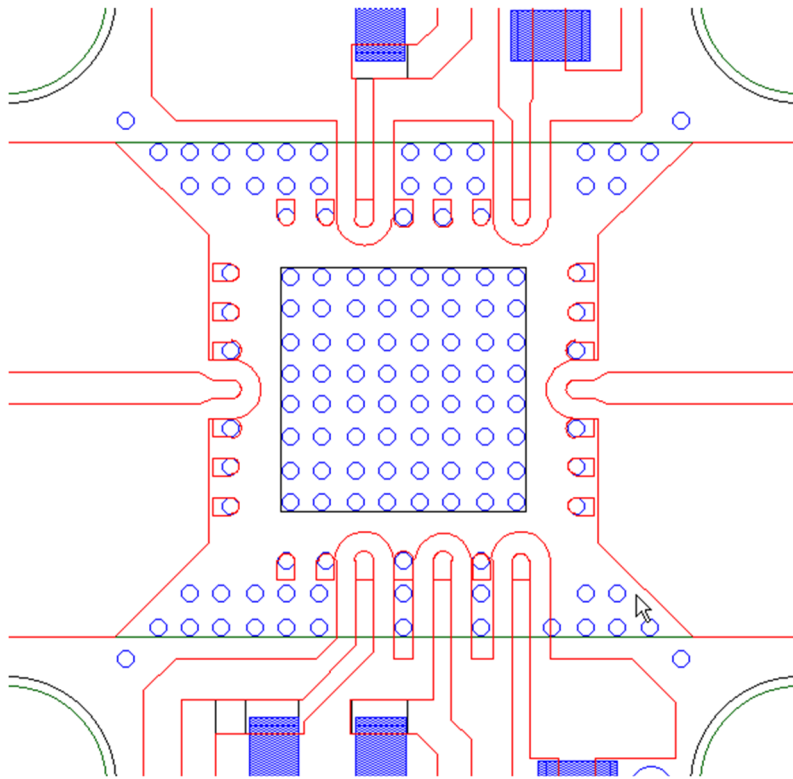

Note:
Multiple copper filled vias are preferred for optimum thermal performance and to minimize inductance to ground.

Mechanical Information

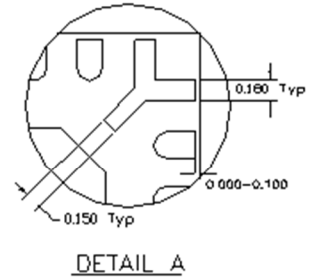
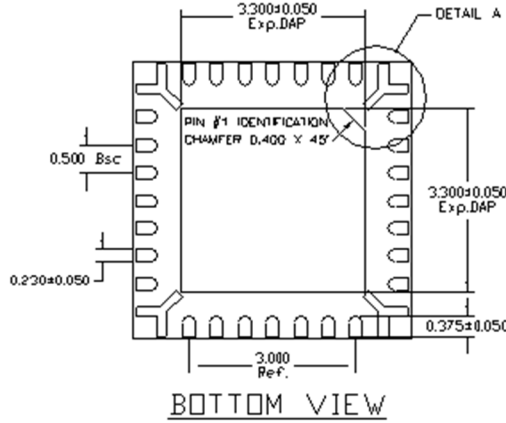
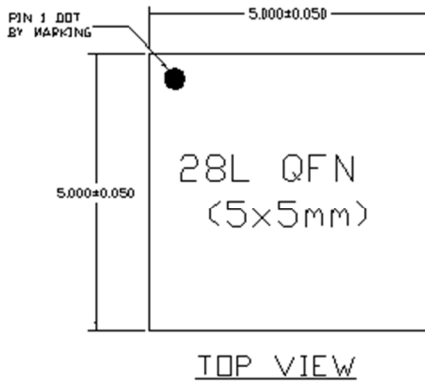

A		QFN
		MAX.
NOM.	0.850	
MIN.	0.800	

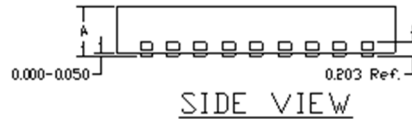

The TGA2731-SM will be marked with the “ZZZZ” and “YYWW” designators and a lot code marked below the part designator. Here, the “ZZZZ” will be “2731”. The “YY” represents the last two digits of the year the part was manufactured, the “WW” is the work week, and the “XXXX” is an auto-generated number.

This package is lead-free/RoHS-compliant. This package is compatible with both lead free and tin-lead soldering processes.

Dimensions are in millimeters.

Pad Description

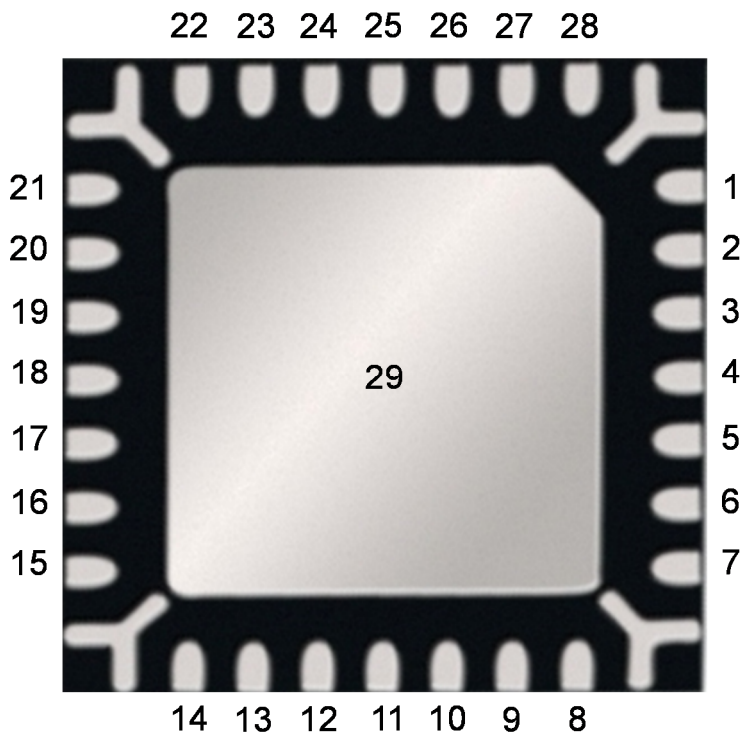

Bottom view of package base

Pin Number	Label	Description
1-3, 5-9, 11 13, 15-17, 19-21, 23-25, 27-28	No Connect	No internal connection. Pads on PCB should be grounded to improve RF isolation
4	RF Input	RF input, matched to 50 Ω , DC blocked
10	V _{SW}	Input attenuator switch control voltage for gain control
12	V _G	Gate voltage
14	Power Sample	Coupled output power
18	RF Output	RF output, matched to 50 Ω , DC blocked
22	V _{D2}	Second stage drain voltage. Bias network required
26	V _{D1}	First stage drain voltage. Bias network required
29	GND	Ground paddle; must be grounded using plated through/copper filled via holes on PCB to improve isolation and for heat sinking

Recommended Soldering Temperature Profile

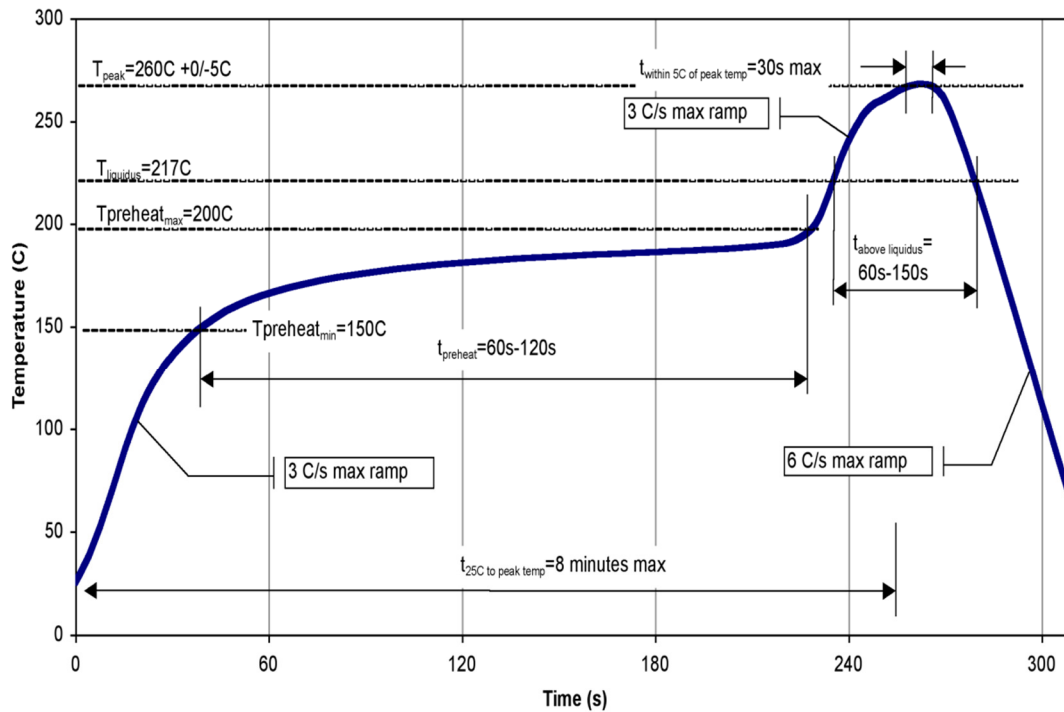

Product Compliance Information

ESD Sensitivity Ratings



Caution! ESD-Sensitive Device

ESD Rating: TBD
Value: TBD
Test: Human Body Model (HBM)
Standard: JEDEC Standard JESD22-A114

ECCN

US Department of Commerce: EAR99

Solderability

Compatible with the latest version of J-STD-020 Lead free solder, 260 °C.

MSL Rating

TBD at 260 °C convection reflow
The part is rated Moisture Sensitivity Level TBD
JEDEC standard IPC/JEDEC J-STD-020.

RoHS-Compliance

This part is compliant with EU 2002/95/EC RoHS directive (Restrictions on the Use of Certain Hazardous Substances in Electrical and Electronic Equipment).

This product also has the following attributes:

- Lead Free
- Halogen Free (Chlorine, Bromine)
- Antimony Free
- TBBP-A (C15H12Br4O2) Free
- PFOS Free
- SVHC Free

Contact Information

For the latest specifications, additional product information, worldwide sales and distribution locations, and information about TriQuint:

Web: www.triquint.com
Email: info-sales@tqs.com

Tel: +1.972.994.8465
Fax: +1.972.994.8504

For technical questions and application information: **Email:** info-products@tqs.com

Important Notice

The information contained herein is believed to be reliable. TriQuint makes no warranties regarding the information contained herein. TriQuint assumes no responsibility or liability whatsoever for any of the information contained herein. TriQuint assumes no responsibility or liability whatsoever for the use of the information contained herein. The information contained herein is provided "AS IS, WHERE IS" and with all faults, and the entire risk associated with such information is entirely with the user. All information contained herein is subject to change without notice. Customers should obtain and verify the latest relevant information before placing orders for TriQuint products. The information contained herein or any use of such information does not grant, explicitly or implicitly, to any party any patent rights, licenses, or any other intellectual property rights, whether with regard to such information itself or anything described by such information.

TriQuint products are not warranted or authorized for use as critical components in medical, life-saving, or life-sustaining applications, or other applications where a failure would reasonably be expected to cause severe personal injury or death.