

Applications

- VSAT
- Point-to-Point Radio
- Test Equipment & Sensors

Product Features

- Frequency Range: 28 – 31 GHz
- Power: 23 dBm P1dB
- Gain: 33 dB
- Output TOI: 31 dBm
- Attenuation Range: 30 dB
- Bias: $V_d = 5\text{ V}$, $I_d = 330\text{ mA}$, $V_g = -0.7\text{ V}$ Typical
- Package Dimensions: 6.0 x 6.0 x 0.85 mm

General Description

The TriQuint TGA4541-SM is a variable gain amplifier to be used as a driver amplifier in linear Ka band applications. The TGA4541-SM operates from 28 to 31 GHz and is designed using TriQuint's pHEMT production process.

The TGA4541-SM typically provides 23 dBm of linear power with 32 dB of small signal gain and 31 dBm of output TOI. The attenuation range is typically 30 dB.

The TGA4541-SM is available in a low-cost, surface mount 40 lead 6x6 QFN package and is ideally suited for VSAT ground terminals and Point-to-Point Radio applications.

Lead-free and RoHS compliant.

Evaluation Boards are available upon request.

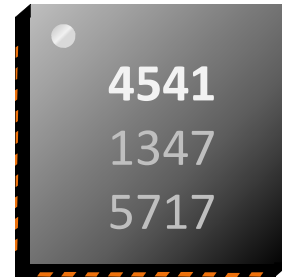

QFN 6x6mm 40L

Functional Block Diagram

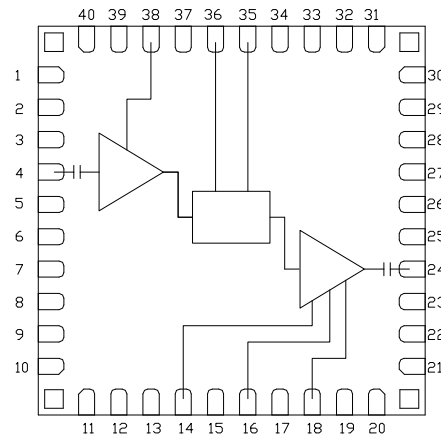

Pin Configuration

Pin #	Symbol
1, 2, 3, 5, 6, 7, 8, 9, 10, 11, 12, 13, 15, 17, 19, 20, 21, 22, 23, 25, 26, 27, 28, 29, 30, 31, 32, 33, 34, 37, 39, 40	N/C
4	RF IN
14	V_g
16	V_{d2}
18	V_{d3}
24	RF OUT
35	V_c
36	Gnd
38	V_{d1}

Ordering Information

Part No.	ECCN	Description
TGA4541-SM	EAR99	Ka-band Variable Gain Amp

Standard T/R size = 500 pieces on a 7" reel.

Specifications

Absolute Maximum Ratings

Parameter	Rating
Drain Voltage, Vd	+6 V
Drain Current, Id1	96 mA
Drain Current, Id2+Id3	672 mA
Power Dissipation, Pdiss	4.0 W
RF Input Power, CW, 50Ω, T = 25°C	+20 dBm
Channel Temperature, Tch	200 °C
Mounting Temperature (30 Seconds)	260 °C
Storage Temperature	-40 to 150 °C

Recommended Operating Conditions

Parameter	Min	Typical	Max	Units
Vd		5		V
Id1		60		mA
Id2+Id3		270		mA
Vg		-0.7		V

Electrical specifications are measured at specified test conditions. Specifications are not guaranteed over all recommended operating conditions.

Operation of this device outside the parameter ranges given above may cause permanent damage. These are stress ratings only, and functional operation of the device at these conditions is not implied.

Electrical Specifications

Test conditions unless otherwise noted: 25°C, Vd = 5 V, Id1 = 60 mA, Id2+Id3 = 270 mA, Vc = -1.0 V, Vg = -0.7 V typical. Id2+Id3 are held constant throughout the test. Z₀: 50 Ω

Parameter	Min	Typical	Max	Units
Operational Frequency Range	28		31	GHz
Gain:				
28 to < 29 GHz	31.5		42	dB
29 to < 30 GHz	31.5		40	dB
30 to 31 GHz	26.5		39	dB
Attenuation Range		30		dB
Input Return Loss		18		dB
Output Return Loss		17		dB
Output Power @ 1dB Gain Compression (max gain):				
28 to < 29 GHz		21		dBm
29 to < 30 GHz		20.5		dBm
30 to 31 GHz		15		dBm
Output TOI		31		dBm
Gain Temperature Coefficient (max gain)		-0.08		dB/°C
Power Temperature Coefficient (max gain)		-0.008		dB/°C

Specifications

Thermal and Reliability Information

Parameter	Condition	Rating
Thermal Resistance, θ_{JC} , measured to back of package	Tbase = 85 °C	$\theta_{JC} = 34.5 \text{ } ^\circ\text{C/W}$
Channel Temperature (Tch), and Median Lifetime (Tm)	Tbase = 85 °C, Vd = 5 V, Id = 330 mA, Pdiss = 1.65 W	Tch = 142 °C Tm = 2.8 E+6 Hours
Channel Temperature (Tch), and Median Lifetime (Tm) Under RF Drive	Tbase = 85 °C, Vd = 5 V, Id = 330 mA, Pout = 24 dBm, Pdiss = 1.40 W	Tch = 133 °C Tm = 7.9 E+6 Hours

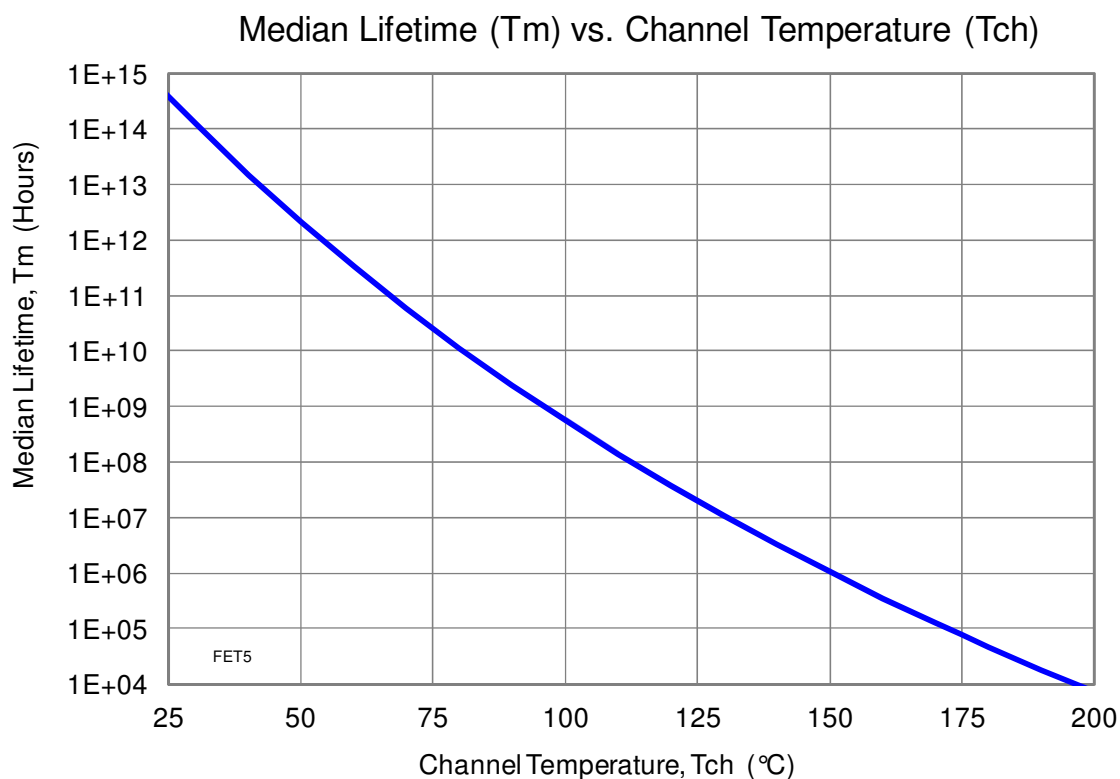

Typical Performance

Id2+Id3 are held constant throughout the test.

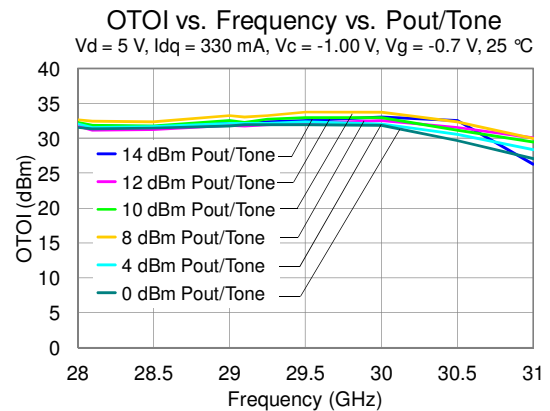
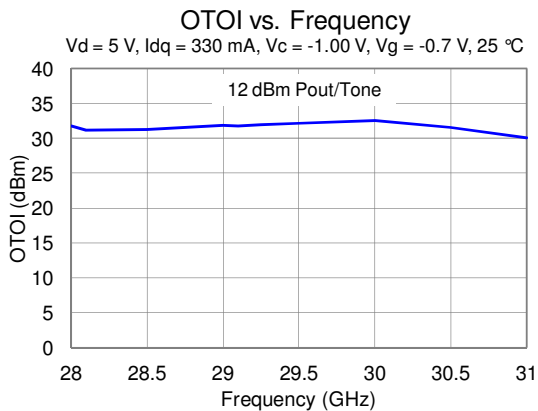
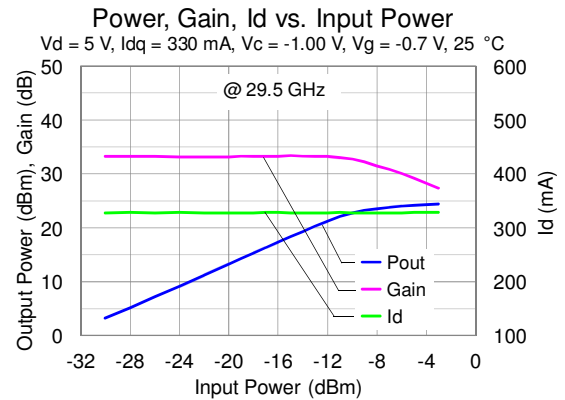
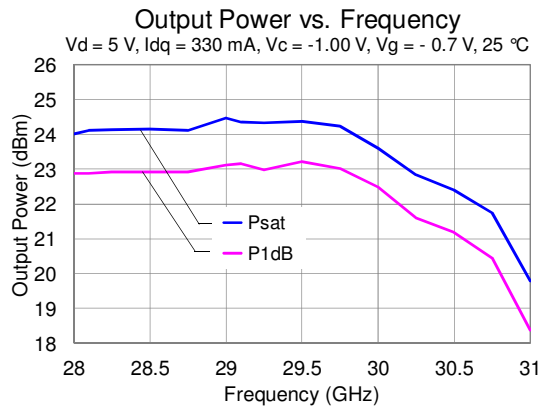
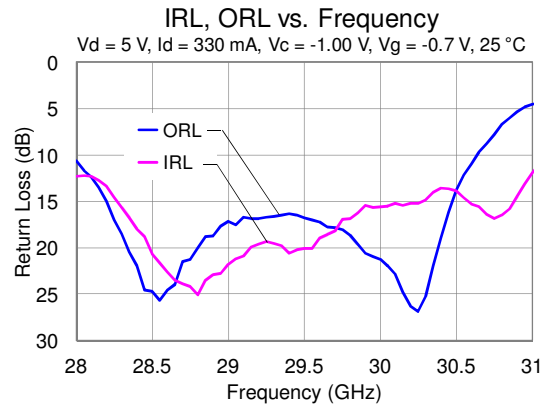
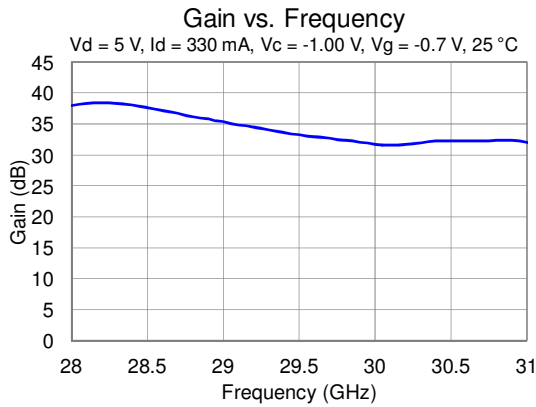

Typical Performance

$I_{d2}+I_{d3}$ are held constant throughout the test.

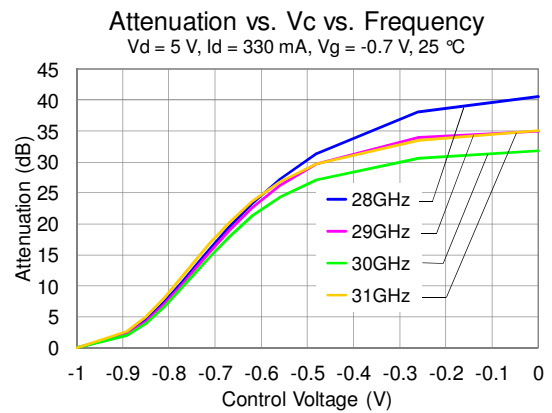
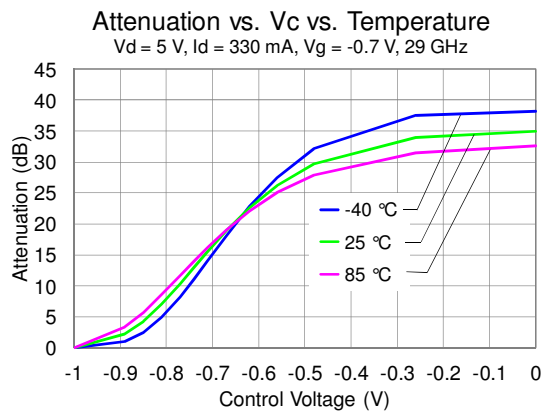
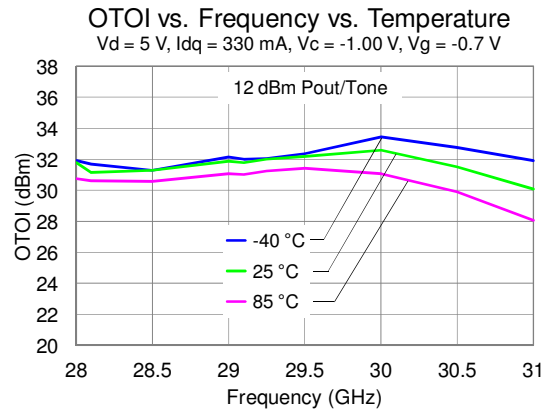
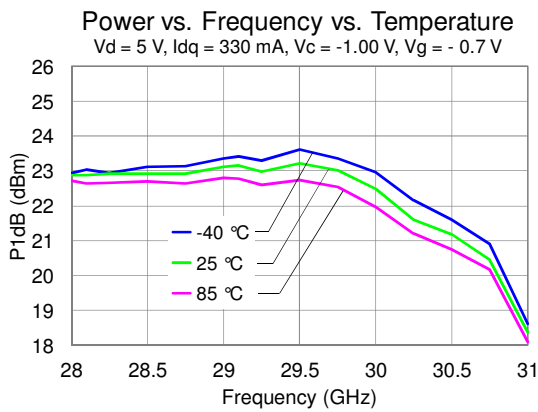
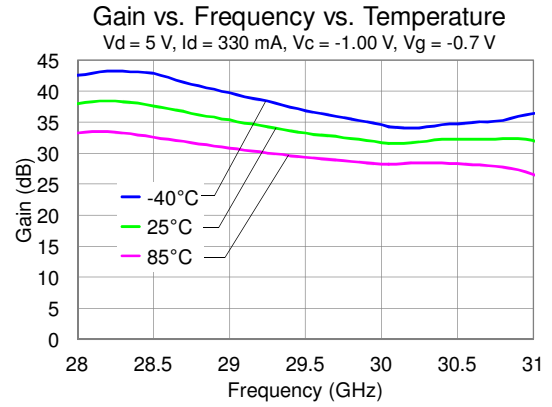
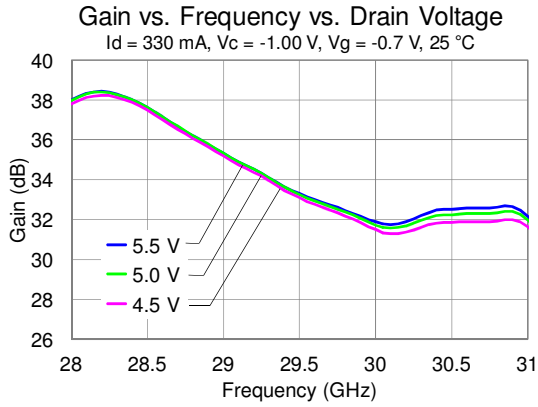

Typical Performance

$I_{d2}+I_{d3}$ are held constant throughout the test.

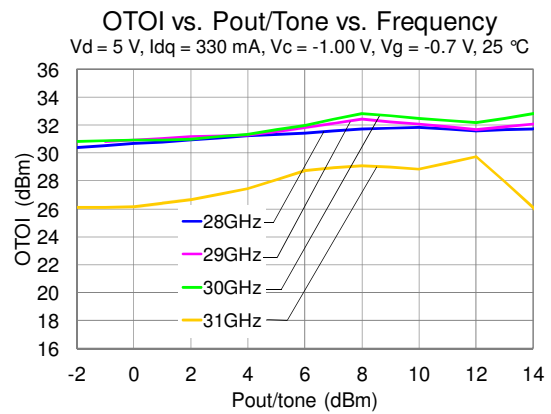
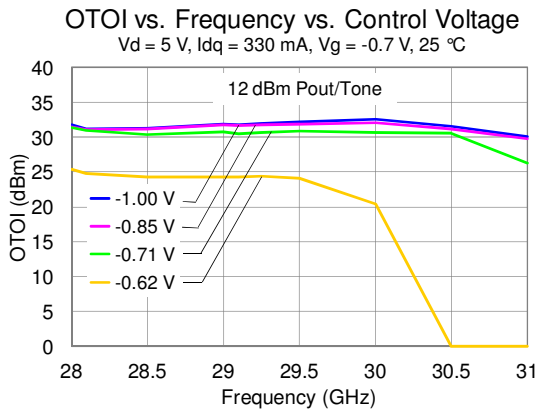
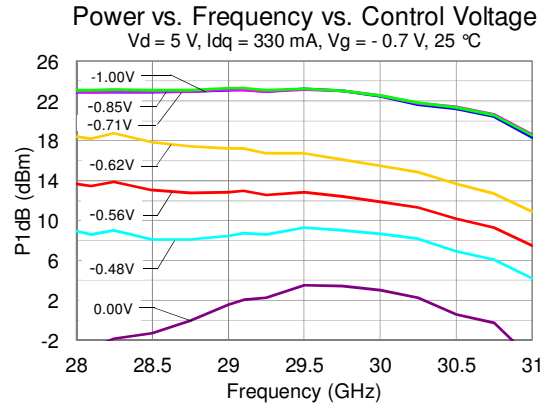
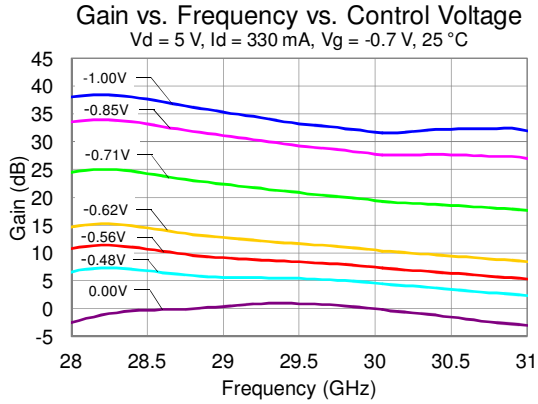

Application Circuit

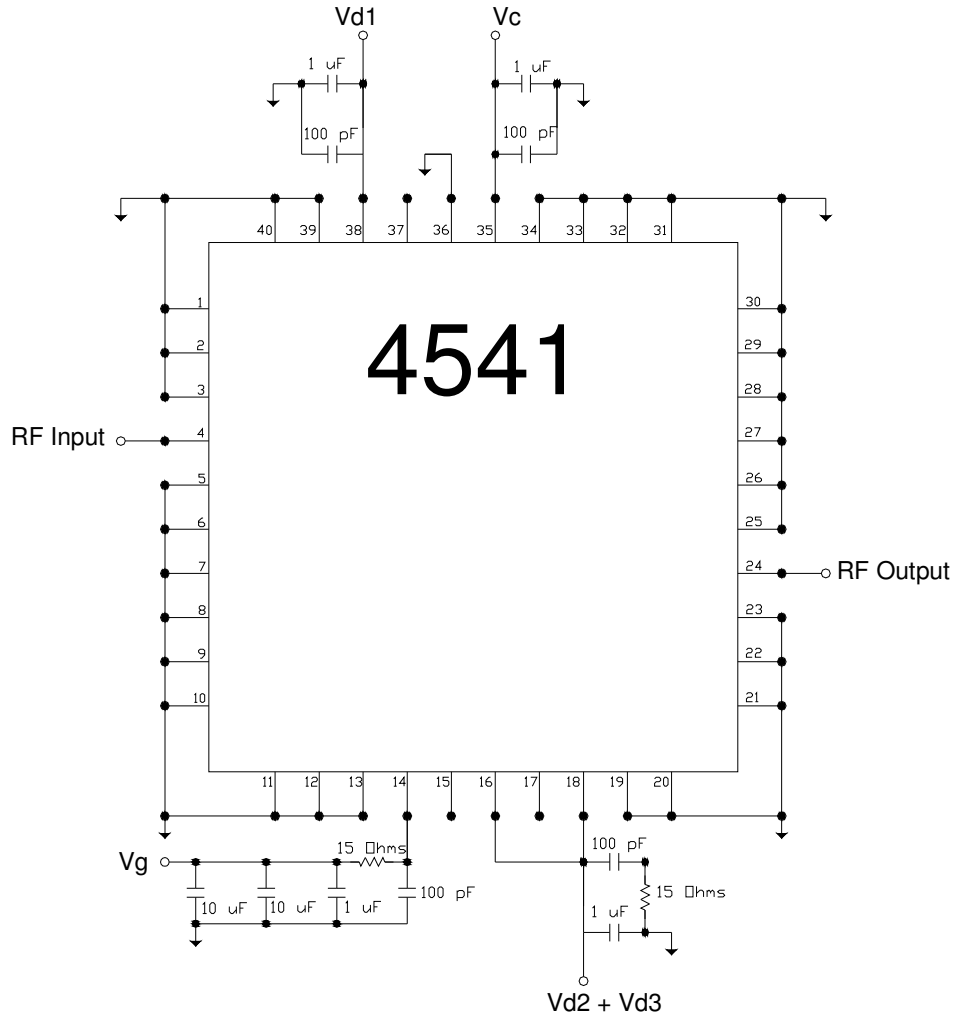

Bias-up Procedure	Bias-down Procedure
Set Vg to -1.5 V	Turn off RF supply
Set Vd1 to 5 V	Reduce Vg to -1.5 V
Set Vd2+Vd3 to 5 V	Set Vc to 0 V
Set Vc to -1.00 V	Reduce Vd2+Vd3 to 0 V
Adjust Vg more positive until quiescent $I_{d2}+I_{d3} = 270$ mA, $I_{d1} = 60$ mA, $V_g \sim -0.7$ V typical	Reduce Vd1 to 0 V
Apply RF signal	
Vd1 and Vd2+Vd3 should be separately monitored.	

Pin Description

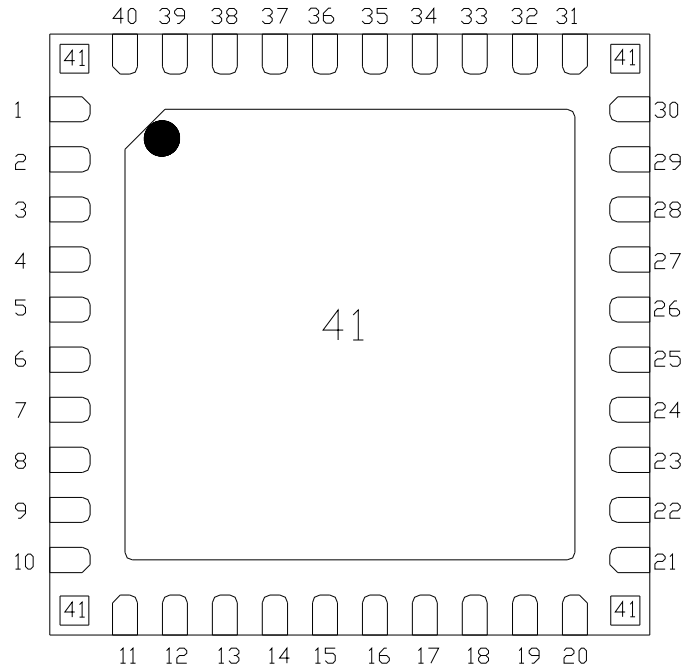

Top View

Pin	Symbol	Description
1, 2, 3, 5, 6, 7, 8, 9, 10, 11, 12, 13, 19, 20, 21, 22, 23, 25, 26, 27, 28, 29, 30, 31, 32, 33, 34, 39, 40	N/C	No internal connection; must be grounded on PCB.
4	RF IN	RF Input.
14	Vg	Gate voltage. Bias network is required; see Application Circuit on page 7 as an example.
15, 17, 37	N/C	No internal connection; should be left open.
16	Vd2	Drain voltage. Bias network is required; see Application Circuit on page 7 as an example.
18	Vd3	Drain voltage. Bias network is required; see Application Circuit on page 7 as an example.
24	RF OUT	RF Output.
35	Vc	Control voltage. Bias network is required; see Application Circuit on page 7 as an example.
36	GND	Internally grounded through a resistor; must be grounded on PCB.
38	Vd1	Drain voltage. Bias network is required; see Application Circuit on page 7 as an example.
41	GND	Backside paddles; must be grounded on PCB. Multiple vias should be employed to minimize inductance and thermal resistance; see Mounting Configuration on page 12 for suggested footprint.

Applications Information

PC Board Layout

Top RF layer is 0.010" thick Rogers RO3203, $\epsilon_r = 3.02$. Metal layers are 1/2-oz copper.

The pad pattern shown has been developed and tested for optimized assembly at TriQuint Semiconductor. The PCB land pattern has been developed to accommodate lead and package tolerances. Since surface mount processes vary from company to company, careful process development is recommended.

For further technical information, refer to the [TGA4541-SM](#) Product Information page.

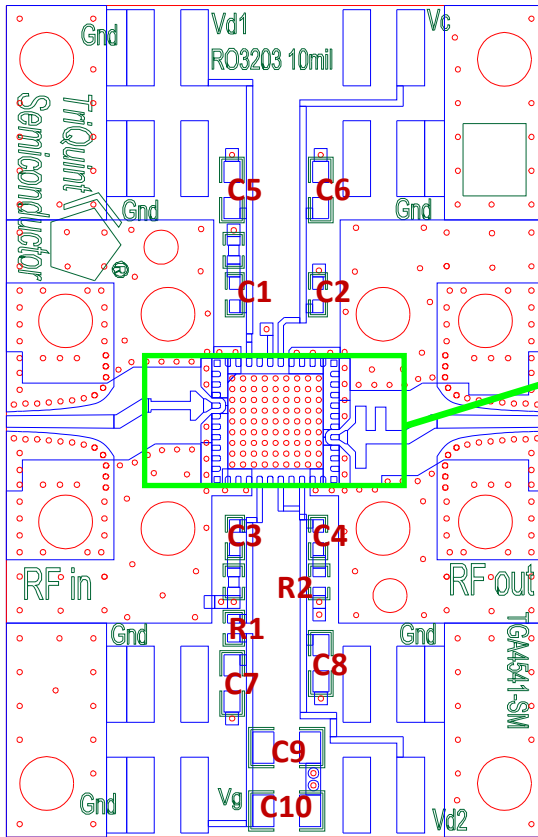
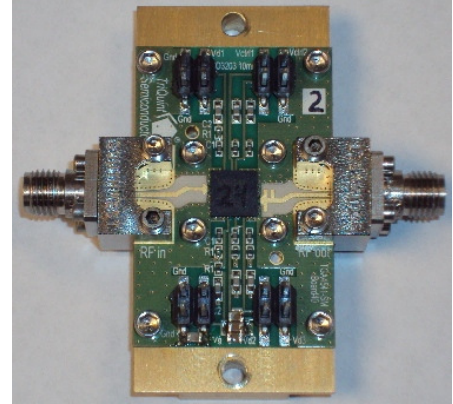

Detail is on the next page

Bill of Materials

Ref Des	Value	Description	Manufacturer	Part Number
C1- C4	100 pF	Cap, 0402, 20V, 5%, COG	various	
C5 - C8	1 μ F	Cap, 0603, 25V, 5%, X5R	various	
C9 - C10	10 μ F	Cap, 0805, 25V, 5%, X5R	various	
R1- R2	15 Ω	Res, 0402, 0.1W, SMD	various	

Applications Information

PC Board Tuning Layout

Dimensions are in millimeters.

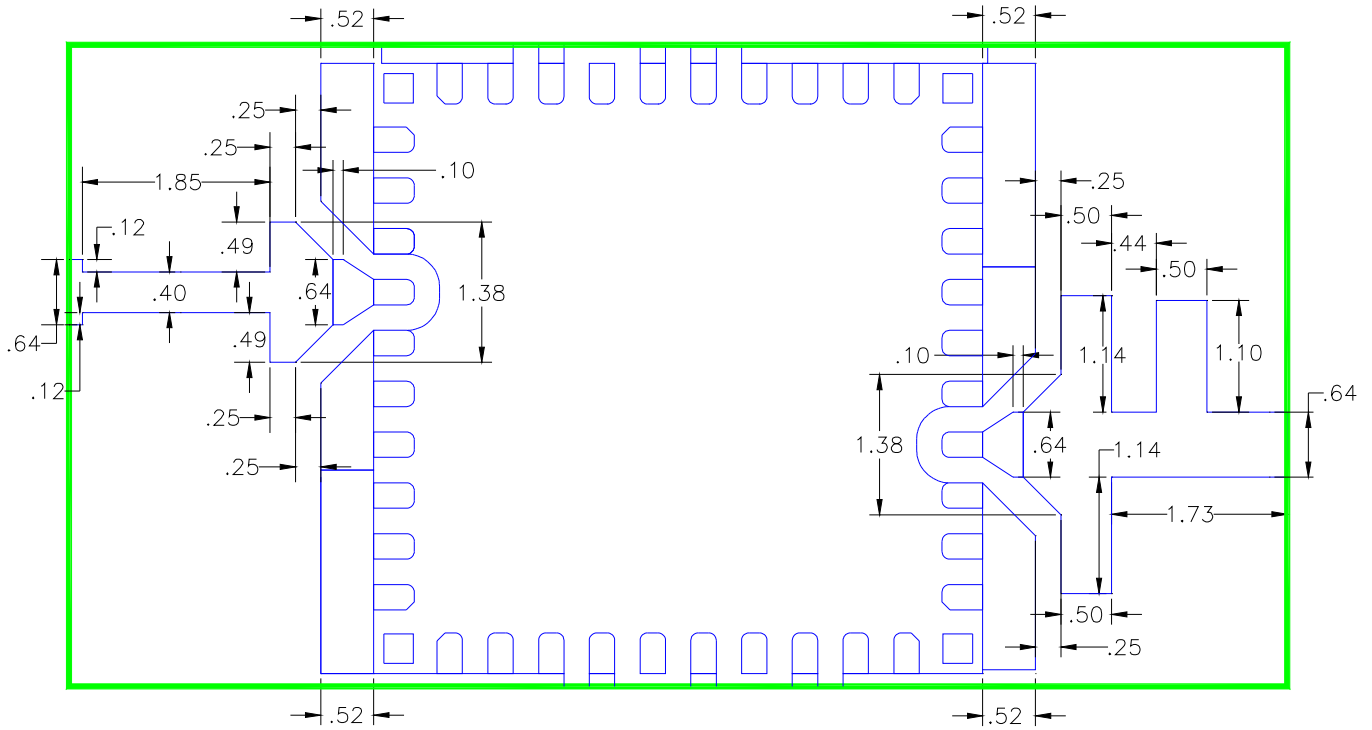

Mechanical Information

Package Information and Dimensions

All dimensions are in millimeters.

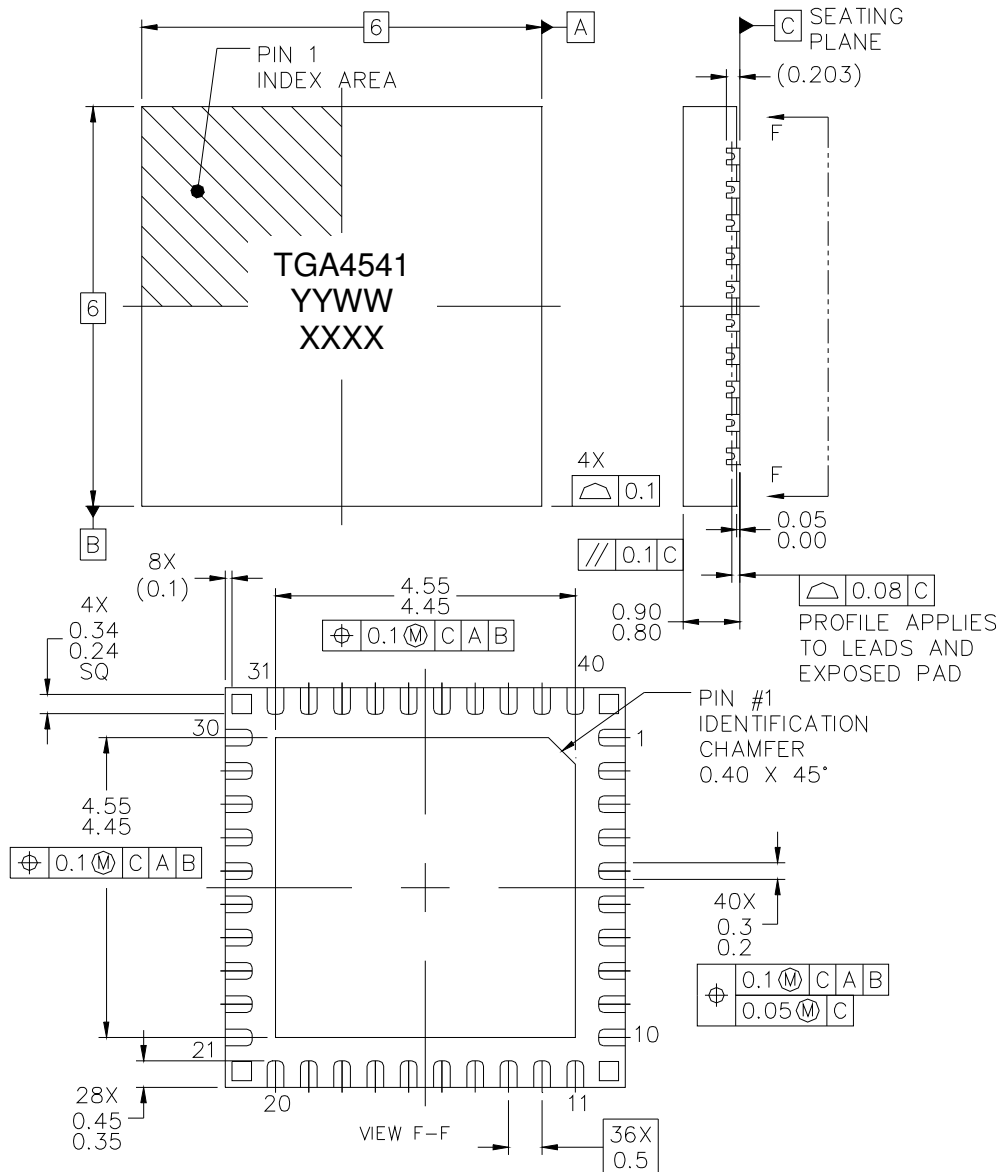

This package is lead-free/RoHS-compliant with a copper alloy base (CDA194), and the plating material on the leads is NiPdAu. It is compatible with both lead-free (maximum 260 °C reflow temperature) and tin-lead (maximum 245 °C reflow temperature) soldering processes.

The TGA4541-SM will be marked with the "4541" designator and a lot code marked below the part designator. The "YY" represents the last two digits of the year the part was manufactured, the "WW" is the work week, and the "XXXX" is an auto-generated assembly lot number.

Mechanical Information

Mounting Configuration

All dimensions are in millimeters.

Notes:

1. Ground vias are critical for the proper performance of this device. Vias have a drill diameter of 0.25 mm.

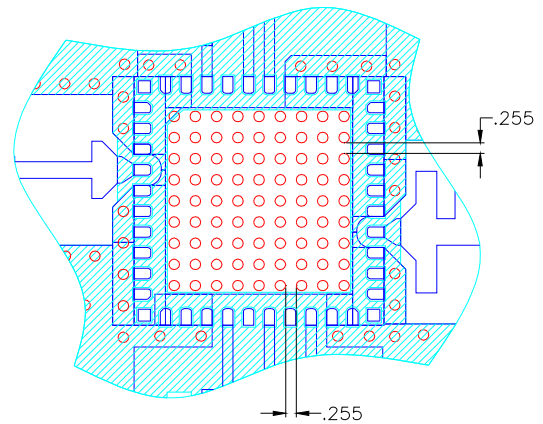

Tape and Reel Information

Tape and reel specifications for this part are also available on the TriQuint website in the "Application Notes" section.

Standard T/R size = 500 pieces on a 7 x 0.5" reel.

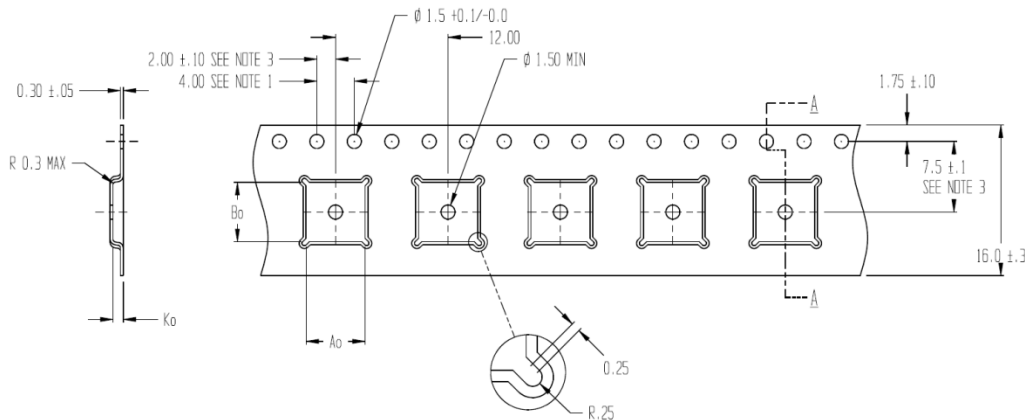

CARRIER AND COVER TAPE DIMENSIONS

Part	Feature	Symbol	Size (in)	Size (mm)
Cavity	Length	A0	0.248	6.3
	Width	B0	0.248	6.3
	Depth	K0	0.043	1.1
	Pitch	P1	0.472	12.0
Distance Between Centerline	Cavity to Perforation Length Direction	P2	0.079	2.0
	Cavity to Perforation Width Direction	F	0.295	7.5
Cover Tape	Width	C	0.561	14.25
Carrier Tape	Width	W	0.63	16.0

Product Compliance Information

ESD Information



Caution! ESD-Sensitive Device

ESD Rating: Class 0
 Value: < 250 V
 Test: Human Body Model (HBM)
 Standard: JEDEC Standard JESD22-A114

MSL Rating

Level 3 at +260 °C convection reflow
 The part is rated Moisture Sensitivity Level 3 at 260 °C per JEDEC standard IPC/JEDEC J-STD-020.

ECCN

US Department of Commerce EAR99

Solderability

Compatible with the latest version of J-STD-020, Lead free solder, 260 °C

This part is compliant with EU 2002/95/EC RoHS directive (Restrictions on the Use of Certain Hazardous Substances in Electrical and Electronic Equipment).

This product also has the following attributes:

- Lead Free
- Halogen Free (Chlorine, Bromine)
- Antimony Free
- TBBP-A (C₁₅H₁₂Br₄O₂) Free
- PFOS Free
- SVHC Free

Recommended Soldering Temperature Profile

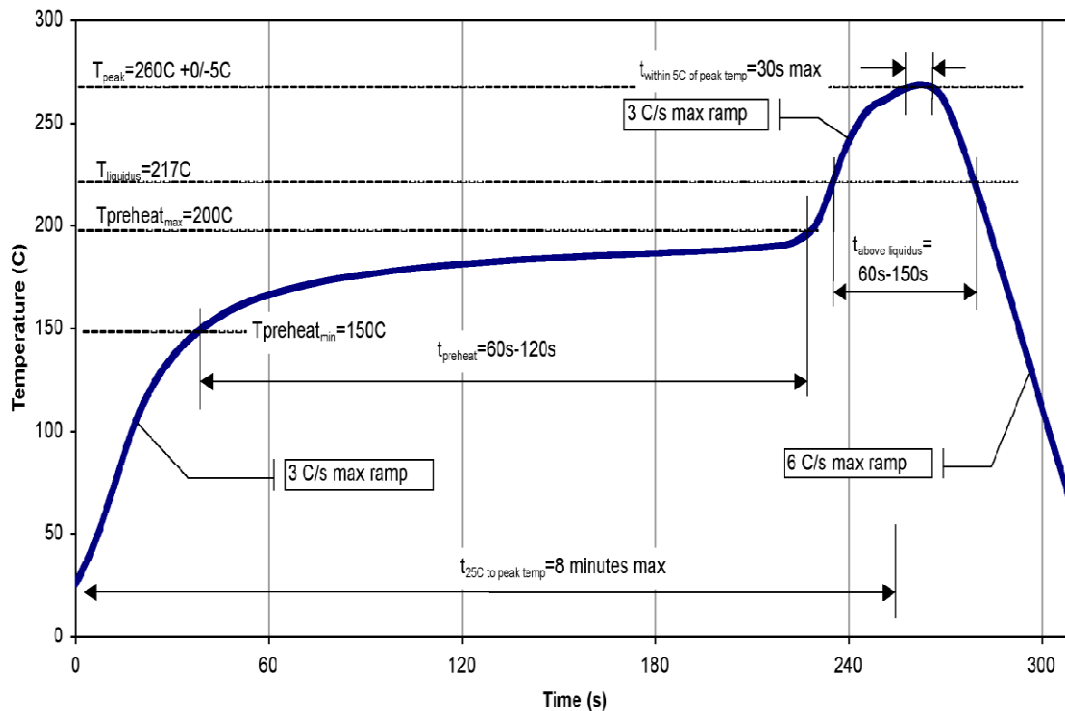

Contact Information

For the latest specifications, additional product information, worldwide sales and distribution locations, and information about TriQuint:

Web: www.triquint.com
Email: info-sales@tqs.com

Tel: +1.972.994.8465
Fax: +1.972.994.8504

For technical questions and application information:

Email: info-networks@tqs.com

Important Notice

The information contained herein is believed to be reliable. TriQuint makes no warranties regarding the information contained herein. TriQuint assumes no responsibility or liability whatsoever for any of the information contained herein. TriQuint assumes no responsibility or liability whatsoever for the use of the information contained herein. The information contained herein is provided "AS IS, WHERE IS" and with all faults, and the entire risk associated with such information is entirely with the user. All information contained herein is subject to change without notice. Customers should obtain and verify the latest relevant information before placing orders for TriQuint products. The information contained herein or any use of such information does not grant, explicitly or implicitly, to any party any patent rights, licenses, or any other intellectual property rights, whether with regard to such information itself or anything described by such information.

TriQuint products are not warranted or authorized for use as critical components in medical, life-saving, or life-sustaining applications, or other applications where a failure would reasonably be expected to cause severe personal injury or death.