

# MA46410 thru MA46485 Series



## GaAs Hyperabrupt Varactor Diode Gamma = 1.0, 1.25, & 1.50

Rev. V6

### Features

- Constant Gamma = 1.0, 1.25 or 1.5
- High Q (up to 4000 at -4 Volts)
- More Linear Frequency Tuning
- High and Nearly Constant Modulation Sensitivity
- Lead-Free (RoHS Compliant) equivalents available with 260°C reflow compatibility.

### Description and Applications

The MA46450, MA46470 and MA46410 series of tuning varactors are hyperabrupt junction Gallium Arsenide diodes featuring constant gamma 1.0 (MA46450 series), 1.25 (MA46470 series) or 1.5 (MA46410 series). These diodes offer high Q (up to 4000) permitting excellent tuning performance from VHF through Ka band. Each part in this series exhibits the large change in capacitance versus bias voltage characteristic of hyperabrupt junctions. The standard capacitance tolerance is  $\pm 10\%$ , with tighter tolerances available. Capacitance matching at one or more bias voltages is also available. All diode types are available in a wide selection of ceramic packages and in chip form. The constant gamma value of 1.0, 1.25 or 1.5 available with these diodes enables the circuit designer to produce significant improvements in circuit performance. Constant gamma tuning varactors permit more linear VCO frequency tuning than do conventional hyperabrupt tuning varactors. These varactors are particularly well suited for use in voltage tuned filters, analog phase shifters, and modulator circuits.

### Common Case styles

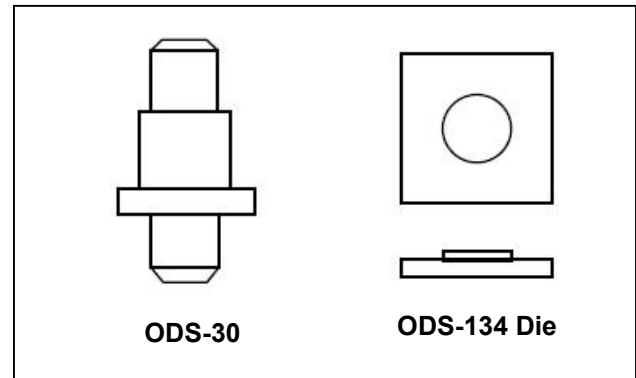

### Absolute Maximum Ratings <sup>1</sup> @ T<sub>A</sub> = +25 °C (Unless Otherwise Noted)

Parameter	Absolute Maximum
Reverse Voltage	Breakdown Voltage
Operating Temperature	-65°C to +175°C
Storage Temperature	65°C to +200°C

1. Operation of this device above any one of these parameters may cause permanent damage. The maximum storage and operating temperature of the plastic ODS-1088 case style is 125°C.

### PACKAGED TUNING VARACTOR EQUIVALENT CIRCUIT

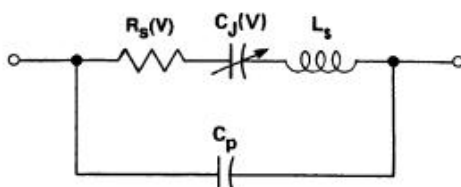

### TYPICAL JUNCTION CAPACITANCE vs TUNING VOLTAGE

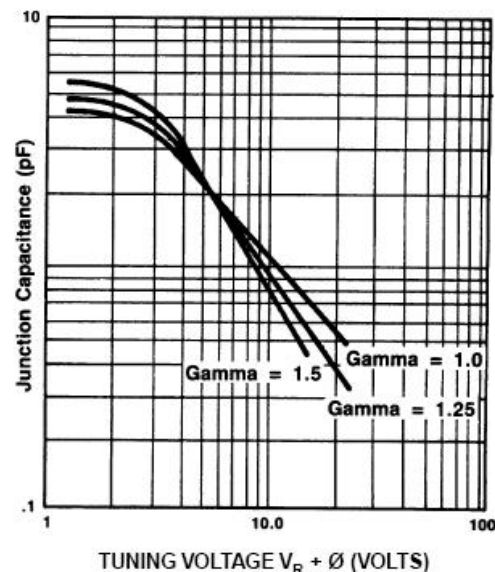

1

**ADVANCED:** Data Sheets contain information regarding a product M/A-COM Technology Solutions is considering for development. Performance is based on target specifications, simulated results, and/or prototype measurements. Commitment to develop is not guaranteed.

**PRELIMINARY:** Data Sheets contain information regarding a product M/A-COM Technology Solutions has under development. Performance is based on engineering tests. Specifications are typical. Mechanical outline has been fixed. Engineering samples and/or test data may be available. Commitment to produce in volume is not guaranteed.

- **North America** Tel: 800.366.2266 / Fax: 978.366.2266
  - **Europe** Tel: 44.1908.574.200 / Fax: 44.1908.574.300
  - **Asia/Pacific** Tel: 81.44.844.8296 / Fax: 81.44.844.8298
- Visit [www.macomtech.com](http://www.macomtech.com) for additional data sheets and product information.

M/A-COM Technology Solutions Inc. and its affiliates reserve the right to make changes to the product(s) or information contained herein without notice.

# MA46410 thru MA46485 Series



## GaAs Hyperabrupt Varactor Diode Gamma = 1.0, 1.25, & 1.50

Rev. V6

### Electrical Specifications @ $T_A = +25^\circ\text{C}$

#### MA46450 Series Gamma = 1.0<sup>4</sup>

$\text{Gamma}^4 = 0.9 - 1.1$ ,  $\text{VR} = 2 - 20$  Volts

Junction Capacitance Ratio ( $\text{CJ2/CJ20}$ ) = 5.0 - 8.0

Breakdown Voltage @  $I_R = 10\mu\text{A}$ ,  $V_b = 22$  V Min

Reverse Leakage Current @  $V_R = 18\text{V}$ ,  $I_R = 100$  nA Max

Part Number	Case Style <sup>2</sup>	Total Capacitance <sup>2,3,4,5</sup> +/-10%	Total Capacitance Ratio <sup>7</sup>	Q Minimum
		$V_r=4$ V	$\frac{V_r=2 \text{ V}}{V_r=20 \text{ V}}$	$V_r=4$ V f=50 MHz
		(pF)	-	-
MA46450	30	0.5	2.0-3.8	4000
MA46451	30	0.7	2.9-4.4	4000
MA46452	30	1.0	3.6-5.2	3000
MA46457	30	2.2	4.1-6.1	3000
MA46461	30	4.7	4.8-7.2	1500

### Electrical Specifications @ $T_A = +25^\circ\text{C}$

#### MA46410 thru MA46425 Series Gamma = 1.5<sup>4</sup>

$\text{Gamma}^4 = 1.4-1.6$   $\text{VR} = 2 - 12$  Volts

Junction Capacitance Ratio ( $\text{CJ2/CJ12}$ ) = 6.2-10.8

Breakdown Voltage @  $I_R = 10\mu\text{A}$ ,  $V_b = 18$  V Min

Reverse Leakage Current @  $V_R = 10\text{V}$ ,  $I_R = 100$  nA Max

Part Number	Case Style <sup>2</sup>	Total Capacitance <sup>3,7,8</sup>	Total Capacitance Ratio <sup>7</sup>	Q Minimum
		$V_r=4$ V	$\frac{V_r=2 \text{ V}}{V_r=12 \text{ V}}$	$V_r=4$ V f=50 MHz
		(pF)	-	-
MA46410	30	0.45-0.60	2.7-4.3	3000
MA46413	30	0.90-1.10	4.2-5.7	2500
MA46416	30	1.62-1.98	5.2-4.9	2500
MA46418	30	2.42-2.97	5.7-7.6	1800
MA46420	30	3.33-4.22	6.0-8.1	1800
MA46425	30	9.00-11.00	6.6-8.8	1200

### Electrical Specifications @ $T_A = +25^\circ\text{C}$

#### MA46470 thru MA46485 Series Gamma = 1.25<sup>4</sup>

$\text{Gamma}^4 = 1.13-1.38$ ,  $\text{VR} = 2 - 20$  Volts

Junction Capacitance Ratio ( $\text{CJ2/CJ20}$ ) = 8.15-12.99

Breakdown Voltage @  $I_R = 10\mu\text{A}$ ,  $V_b = 22$  V Min

Reverse Leakage Current @  $V_R = 18\text{V}$ ,  $I_R = 100$  nA Max

Part Number	Case Style <sup>2</sup>	Total Capacitance <sup>2,3,4,5</sup> +/-10%	Total Capacitance Ratio <sup>7</sup>	Q Minimum
		$V_r=4$ V	$\frac{V_r=2 \text{ V}}{V_r=20 \text{ V}}$	$V_r=4$ V f=50 MHz
		(pF)	-	-
MA46470	30	0.5	2.2/4.1	4000
MA46471	30	0.7	3.6/5.6	4000
MA46472	30	1.0	4.8/7.4	3000
MA46473	30	1.2	4.8/7.4	3000
MA46474	30	1.5	5.0/7.4	3000
MA46475	30	1.8	6.6/8.7	3000
MA46476	30	2.0	6.6/8.7	3000
MA46477	30	2.2	6.6/8.7	3000
MA46479	30	3.3	6.4/10.0	2000
MA46480	30	3.7	6.8/11.0	2000
MA46481	30	5.1	6.9/11.1	1500
MA46483	30	6.8	7.2/11.5	1500
MA46485	30	10.0	7.5/12.0	1500

- All GaAs tuning varactors are available in chip form as well as the case styles shown on the following page. When ordering, specify the desired case by adding the case designation as a suffix to the type number.
- Case parasitics ( $C_p$  and  $L_s$ ) are given for most case styles along with case outlines in the appendix. The  $C_p$  values listed typically have tolerances of  $\pm 0.02$  pF.
- The nominal tolerance at -4 Volts is  $\pm 10\%$ . Closer tolerances are available upon request. By adding the suffix A to the part number, a tolerance of  $\pm 5\%$  at -4 Volts is guaranteed.
- The values guaranteed for gamma are measured on un-packaged chips. The total capacitance versus bias voltage curve will deviate slightly from the chip capacitance versus bias voltage curve due to the package parasitic capacitance ( $C_p$ ).
- Capacitance is measured at 1 MHz.
- Reverse voltage ( $V_B$ ) is measured at 10 microamps.
- The total capacitance and capacitance ratios shown are for diodes housed in case style 30. Other case styles will result in different values.

**ADVANCED:** Data Sheets contain information regarding a product M/A-COM Technology Solutions is considering for development. Performance is based on target specifications, simulated results, and/or prototype measurements. Commitment to develop is not guaranteed.

**PRELIMINARY:** Data Sheets contain information regarding a product M/A-COM Technology Solutions has under development. Performance is based on engineering tests. Specifications are typical. Mechanical outline has been fixed. Engineering samples and/or test data may be available. Commitment to produce in volume is not guaranteed.

• **North America** Tel: 800.366.2266 / Fax: 978.366.2266

• **Europe** Tel: 44.1908.574.200 / Fax: 44.1908.574.300

• **Asia/Pacific** Tel: 81.44.844.8296 / Fax: 81.44.844.8298

Visit [www.macomtech.com](http://www.macomtech.com) for additional data sheets and product information.

M/A-COM Technology Solutions Inc. and its affiliates reserve the right to make changes to the product(s) or information contained herein without notice.

# MA46410 thru MA46485 Series



GaAs Hyperabrupt Varactor Diode  
Gamma = 1.0, 1.25, & 1.50

Rev. V6

## Typical Performance Curves

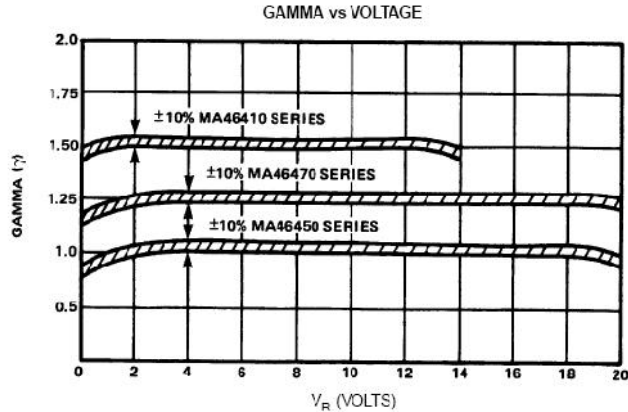

TOTAL CAPACITANCE vs REVERSE BIAS VOLTAGE (γ = 1.0)  
(PARTS IN CASE STYLE 30)

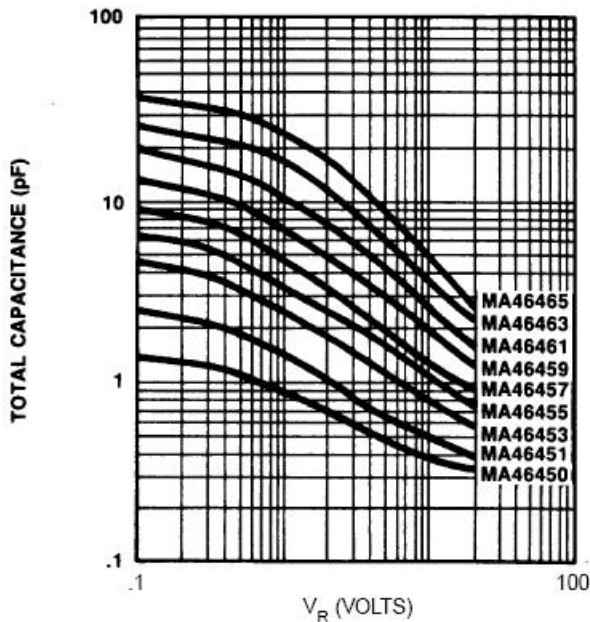

JUNCTION CAPACITANCE vs REVERSE BIAS VOLTAGE (γ = 1.0)  
(CHIPS)

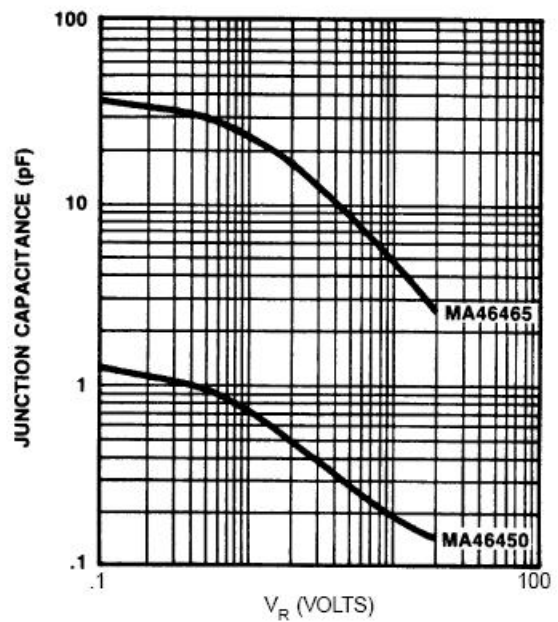

**ADVANCED:** Data Sheets contain information regarding a product M/A-COM Technology Solutions is considering for development. Performance is based on target specifications, simulated results, and/or prototype measurements. Commitment to develop is not guaranteed.

**PRELIMINARY:** Data Sheets contain information regarding a product M/A-COM Technology Solutions has under development. Performance is based on engineering tests. Specifications are typical. Mechanical outline has been fixed. Engineering samples and/or test data may be available. Commitment to produce in volume is not guaranteed.

- **North America** Tel: 800.366.2266 / Fax: 978.366.2266
  - **Europe** Tel: 44.1908.574.200 / Fax: 44.1908.574.300
  - **Asia/Pacific** Tel: 81.44.844.8296 / Fax: 81.44.844.8298
- Visit [www.macomtech.com](http://www.macomtech.com) for additional data sheets and product information.

M/A-COM Technology Solutions Inc. and its affiliates reserve the right to make changes to the product(s) or information contained herein without notice.

# MA46410 thru MA46485 Series



**GaAs Hyperabrupt Varactor Diode**  
**Gamma = 1.0, 1.25, & 1.50**

Rev. V6

## Typical Performance Curves

TOTAL CAPACITANCE vs REVERSE BIAS VOLTAGE ( $\gamma = 1.25$ )  
 (PARTS IN CASE STYLE 30)

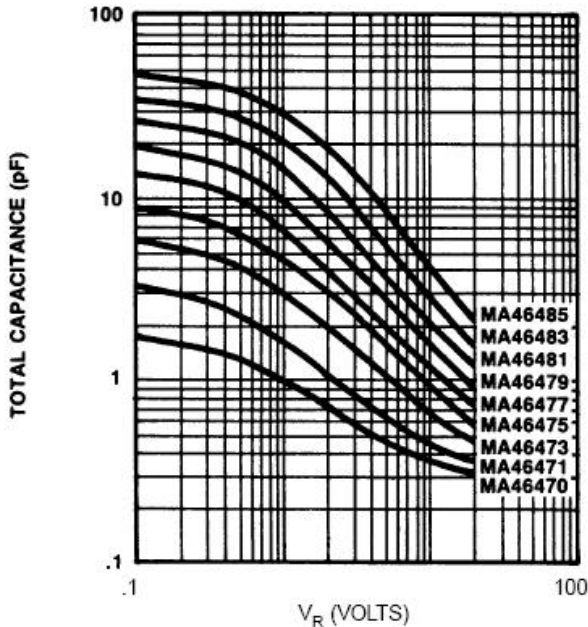

JUNCTION CAPACITANCE vs REVERSE BIAS VOLTAGE ( $\gamma = 1.25$ )  
 (CHIPS)

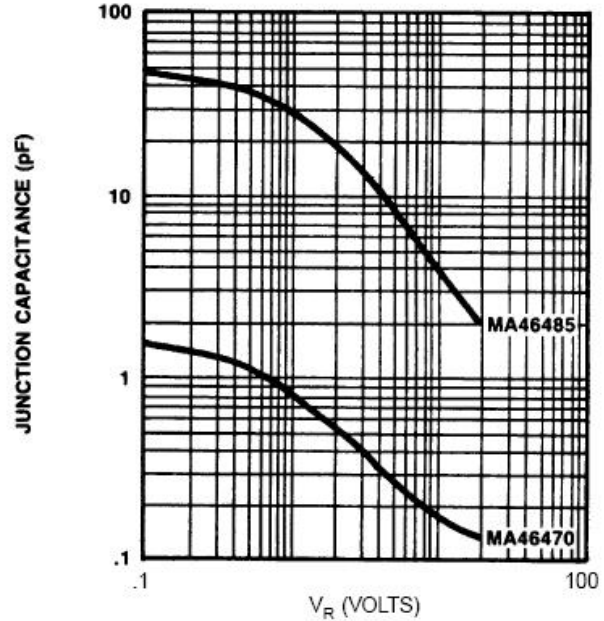

TOTAL CAPACITANCE vs REVERSE BIAS VOLTAGE ( $\gamma = 1.5$ )  
 (PARTS IN CASE STYLE 30)

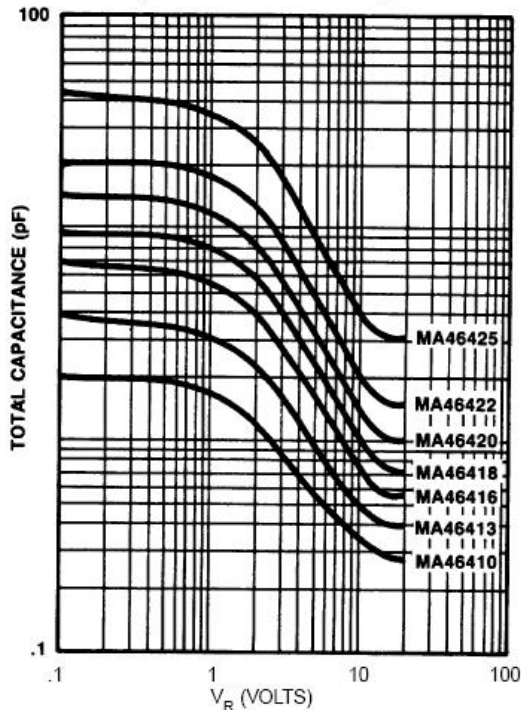

JUNCTION CAPACITANCE vs REVERSE BIAS VOLTAGE ( $\gamma = 1.5$ )  
 (CHIPS)

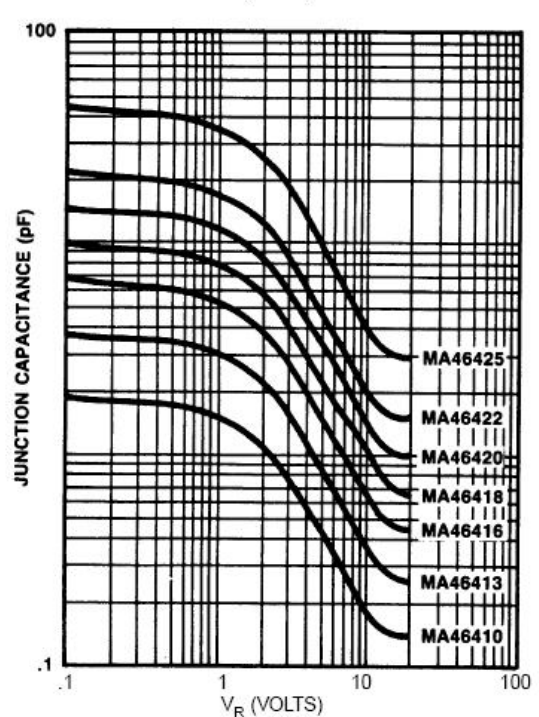

**ADVANCED:** Data Sheets contain information regarding a product M/A-COM Technology Solutions is considering for development. Performance is based on target specifications, simulated results, and/or prototype measurements. Commitment to develop is not guaranteed.  
**PRELIMINARY:** Data Sheets contain information regarding a product M/A-COM Technology Solutions has under development. Performance is based on engineering tests. Specifications are typical. Mechanical outline has been fixed. Engineering samples and/or test data may be available. Commitment to produce in volume is not guaranteed.

- **North America** Tel: 800.366.2266 / Fax: 978.366.2266
  - **Europe** Tel: 44.1908.574.200 / Fax: 44.1908.574.300
  - **Asia/Pacific** Tel: 81.44.844.8296 / Fax: 81.44.844.8298
- Visit [www.macomtech.com](http://www.macomtech.com) for additional data sheets and product information.

M/A-COM Technology Solutions Inc. and its affiliates reserve the right to make changes to the product(s) or information contained herein without notice.

# MA46410 thru MA46485 Series



**GaAs Hyperabrupt Varactor Diode**  
**Gamma = 1.0, 1.25, & 1.50**

Rev. V6

## Environmental Ratings PER MIL-STD-750

	Method	Level
Storage Temperature	1031	See Max. Ratings
Temperature Cycle	1051	10 cycles, -65°C to +175°C
Shock	2016	500 g's
Vibration	2056	15 g's

## Case Styles (Dimensions are available upon request)

### Typical Coaxial Packages

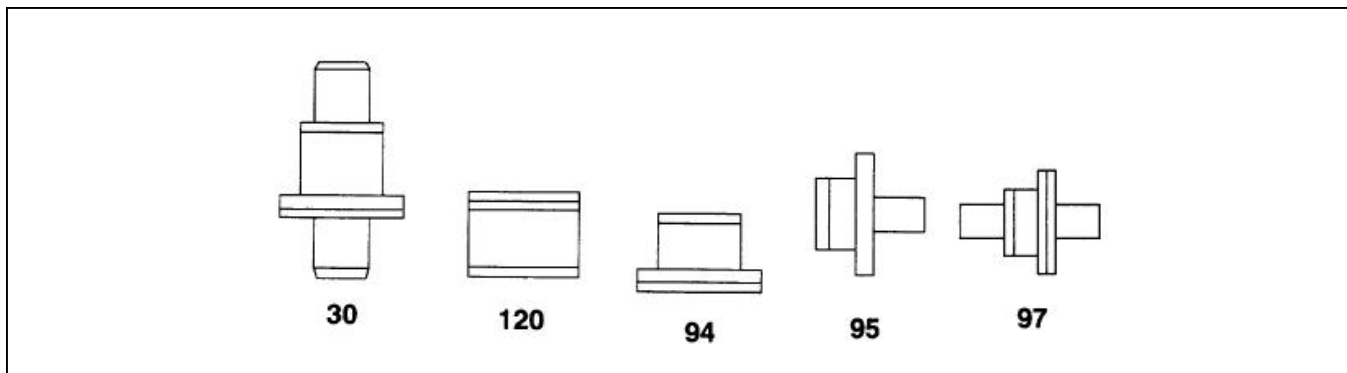

### Typical Coplanar Packages

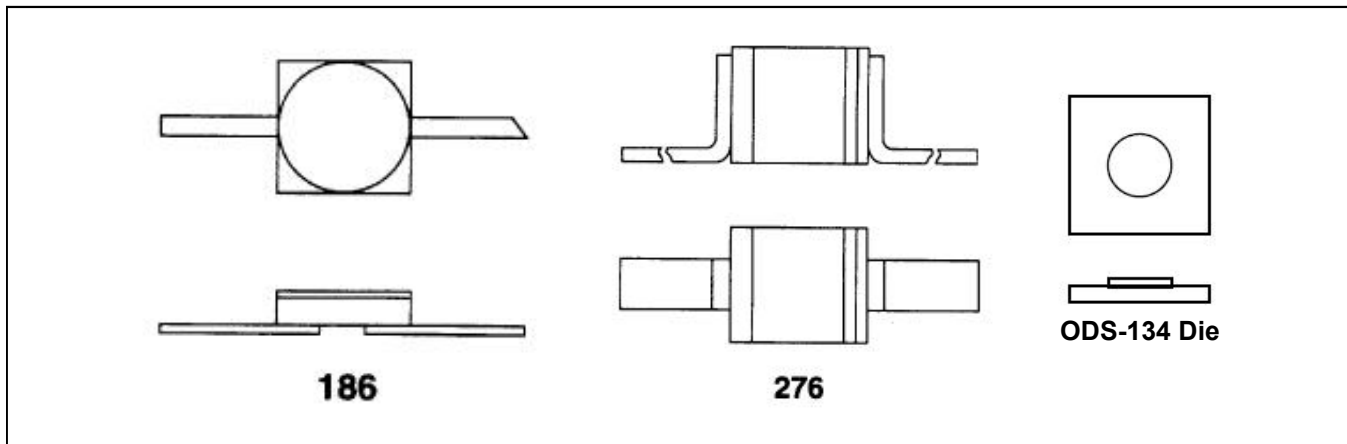

**ADVANCED:** Data Sheets contain information regarding a product M/A-COM Technology Solutions is considering for development. Performance is based on target specifications, simulated results, and/or prototype measurements. Commitment to develop is not guaranteed.

**PRELIMINARY:** Data Sheets contain information regarding a product M/A-COM Technology Solutions has under development. Performance is based on engineering tests. Specifications are typical. Mechanical outline has been fixed. Engineering samples and/or test data may be available. Commitment to produce in volume is not guaranteed.

- **North America** Tel: 800.366.2266 / Fax: 978.366.2266
- **Europe** Tel: 44.1908.574.200 / Fax: 44.1908.574.300
- **Asia/Pacific** Tel: 81.44.844.8296 / Fax: 81.44.844.8298

Visit [www.macomtech.com](http://www.macomtech.com) for additional data sheets and product information.

*M/A-COM Technology Solutions Inc. and its affiliates reserve the right to make changes to the product(s) or information contained herein without notice.*