

**Full - Bridge
Series & SiC parallel diodes
Super Junction
MOSFET Power Module**

**$V_{DSS} = 600V$
 $R_{DSon} = 45m\Omega \text{ max @ } T_j = 25^\circ C$
 $I_D = 49A @ T_c = 25^\circ C$**

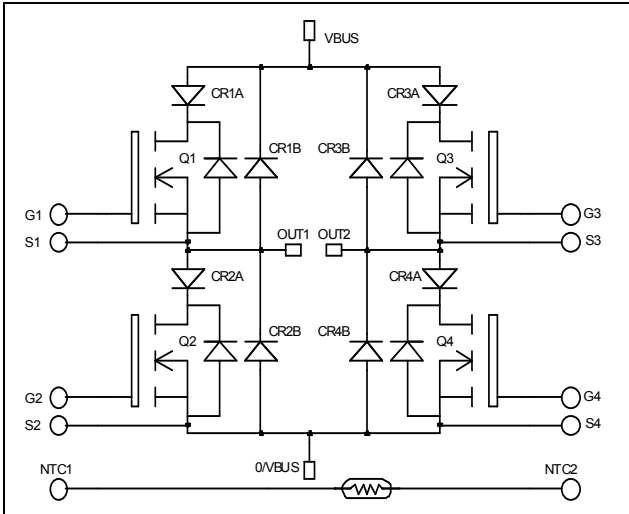

Application

- Motor control
- Switched Mode Power Supplies
- Uninterruptible Power Supplies

Features

- **COOLMOS** Power Semiconductors
 - Ultra low R_{DSon}
 - Low Miller capacitance
 - Ultra low gate charge
 - Avalanche energy rated
- **Parallel SiC Schottky Diode**
 - Zero reverse recovery
 - Zero forward recovery
 - Temperature Independent switching behavior
 - Positive temperature coefficient on VF
- Kelvin source for easy drive
- Very low stray inductance
 - Symmetrical design
 - Lead frames for power connections
- Internal thermistor for temperature monitoring
- High level of integration

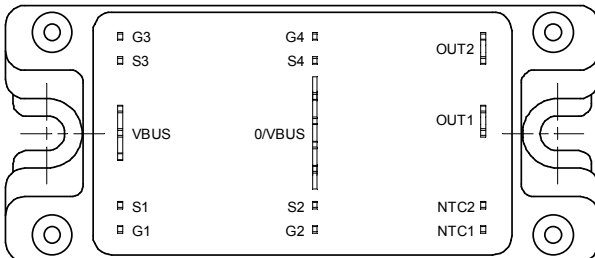

Benefits

- Outstanding performance at high frequency operation
- Direct mounting to heatsink (isolated package)
- Low junction to case thermal resistance
- Solderable terminals both for power and signal for easy PCB mounting
- Low profile
- RoHS compliant

Absolute maximum ratings

Symbol	Parameter	Max ratings	Unit
V_{DSS}	Drain - Source Breakdown Voltage	600	V
I_D	Continuous Drain Current	$T_c = 25^\circ C$	49
		$T_c = 80^\circ C$	38
I_{DM}	Pulsed Drain current	130	A
V_{GS}	Gate - Source Voltage	± 20	V
R_{DSon}	Drain - Source ON Resistance	45	$m\Omega$
P_D	Maximum Power Dissipation	$T_c = 25^\circ C$	250
I_{AR}	Avalanche current (repetitive and non repetitive)	15	A
E_{AR}	Repetitive Avalanche Energy	3	mJ
E_{AS}	Single Pulse Avalanche Energy	1900	

CAUTION: These Devices are sensitive to Electrostatic Discharge. Proper Handling Procedures Should Be Followed. See application note APT0502 on www.microsemi.com

All ratings @ $T_j = 25^\circ\text{C}$ unless otherwise specified

Electrical Characteristics

Symbol	Characteristic	Test Conditions	Min	Typ	Max	Unit
I_{DSS}	Zero Gate Voltage Drain Current	$V_{GS} = 0V, V_{DS} = 600V$			25	μA
		$T_j = 25^\circ\text{C}$				
		$V_{GS} = 0V, V_{DS} = 600V$			250	
$R_{DS(on)}$	Drain – Source on Resistance	$V_{GS} = 10V, I_D = 22.5A$		40	45	$\text{m}\Omega$
$V_{GS(th)}$	Gate Threshold Voltage	$V_{GS} = V_{DS}, I_D = 3\text{mA}$	2.1	3	3.9	V
I_{GSS}	Gate – Source Leakage Current	$V_{GS} = \pm 20V, V_{DS} = 0V$			100	nA

Dynamic Characteristics

Symbol	Characteristic	Test Conditions	Min	Typ	Max	Unit
C_{iss}	Input Capacitance	$V_{GS} = 0V; V_{DS} = 25V$		7.2		nF
C_{oss}	Output Capacitance	$f = 1\text{MHz}$		8.5		
Q_g	Total gate Charge	$V_{GS} = 10V$		150		nC
Q_{gs}	Gate – Source Charge	$V_{Bus} = 300V$		34		
Q_{gd}	Gate – Drain Charge	$I_D = 44A$		51		
$T_{d(on)}$	Turn-on Delay Time	Inductive switching @ 125°C $V_{GS} = 10V$ $V_{Bus} = 400V$ $I_D = 50A$ $R_G = 5\Omega$		21		ns
T_r	Rise Time			30		
$T_{d(off)}$	Turn-off Delay Time			100		
T_f	Fall Time			45		
E_{on}	Turn-on Switching Energy	Inductive switching @ 25°C $V_{GS} = 10V; V_{Bus} = 400V$ $I_D = 50A; R_G = 5\Omega$		405		μJ
E_{off}	Turn-off Switching Energy			520		
E_{on}	Turn-on Switching Energy	Inductive switching @ 125°C $V_{GS} = 10V; V_{Bus} = 400V$ $I_D = 50A; R_G = 5\Omega$		658		μJ
E_{off}	Turn-off Switching Energy			635		

Series diode ratings and characteristics

Symbol	Characteristic	Test Conditions	Min	Typ	Max	Unit
V_{RRM}	Maximum Peak Repetitive Reverse Voltage		200			V
I_{RM}	Maximum Reverse Leakage Current	$V_R = 200V$	$T_j = 25^\circ\text{C}$		250	μA
			$T_j = 125^\circ\text{C}$		500	
I_F	DC Forward Current			30		A
V_F	Diode Forward Voltage	$I_F = 30A$		1.1	1.15	V
		$I_F = 60A$		1.4		
		$I_F = 30A$	$T_j = 125^\circ\text{C}$	0.9		
t_{rr}	Reverse Recovery Time	$I_F = 30A$ $V_R = 133V$ $di/dt = 200A/\mu\text{s}$	$T_j = 25^\circ\text{C}$	24		ns
			$T_j = 125^\circ\text{C}$	48		
Q_{rr}	Reverse Recovery Charge	$I_F = 30A$ $V_R = 133V$ $di/dt = 200A/\mu\text{s}$	$T_j = 25^\circ\text{C}$	33		nC
			$T_j = 125^\circ\text{C}$	150		

Parallel diode ratings and characteristics

Symbol	Characteristic	Test Conditions	Min	Typ	Max	Unit
V _{RRM}	Maximum Peak Repetitive Reverse Voltage		600			V
I _{RM}	Maximum Reverse Leakage Current	V _R =600V		T _j = 25°C 100 T _j = 175°C 200	400 2000	μA
I _F	DC Forward Current			T _c = 100°C 20		A
V _F	Diode Forward Voltage	I _F = 20A		T _j = 25°C 1.6 T _j = 175°C 2.0	1.8 2.4	V
Q _C	Total Capacitive Charge	I _F = 20A, V _R = 300V di/dt = 800A/μs		28		nC
C	Total Capacitance	f = 1MHz, V _R = 200V f = 1MHz, V _R = 400V		130 100		pF

Thermal and package characteristics

Symbol	Characteristic	Min	Typ	Max	Unit	
R _{thJC}	Junction to Case Thermal Resistance	Transistor			0.5	°C/W
		Series diode			1.2	
		Parallel diode			1.5	
V _{ISOL}	RMS Isolation Voltage, any terminal to case t = 1 min, I _{isol} < 1mA, 50/60Hz	4000			V	
T _J	Operating junction temperature range	-40		150	°C	
T _{STG}	Storage Temperature Range	-40		125		
T _C	Operating Case Temperature	-40		100		
Torque	Mounting torque	To Heatsink	M5	1.5		4.7
Wt	Package Weight				160	g

Temperature sensor NTC (see application note APT0406 on www.microsemi.com for more information).

Symbol	Characteristic	Min	Typ	Max	Unit
R ₂₅	Resistance @ 25°C		50		kΩ
ΔR ₂₅ /R ₂₅			5		%
B _{25/85}	T ₂₅ = 298.15 K		3952		K
ΔB/B		T _C = 100°C	4		%

$$R_T = \frac{R_{25}}{\exp\left[B_{25/85}\left(\frac{1}{T_{25}} - \frac{1}{T}\right)\right]}$$

T: Thermistor temperature
 R_T: Thermistor value at T

SP4 Package outline (dimensions in mm)

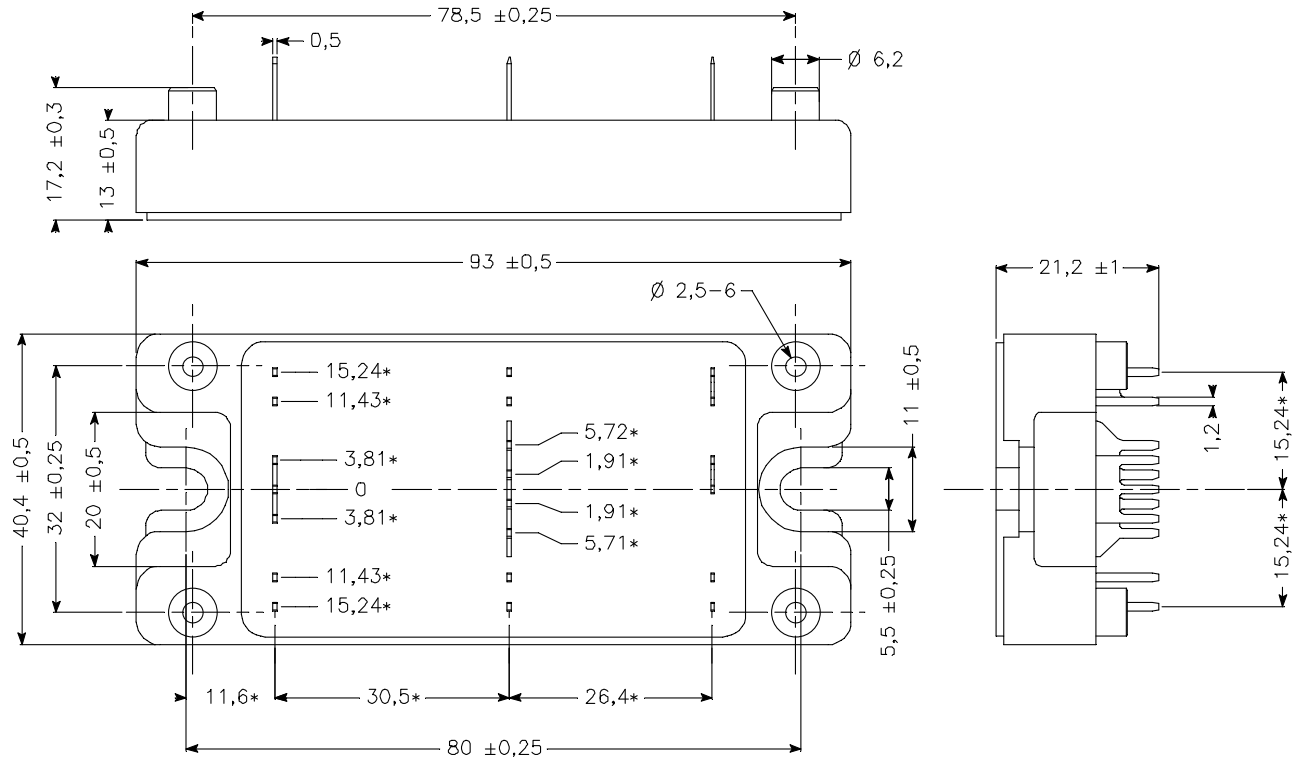

ALL DIMENSIONS MARKED "*" ARE TOLERANCED AS: $\oplus \varnothing 1$

See application note APT0501 - Mounting Instructions for SP4 Power Modules on www.microsemi.com

Typical CoolMOS Performance Curve

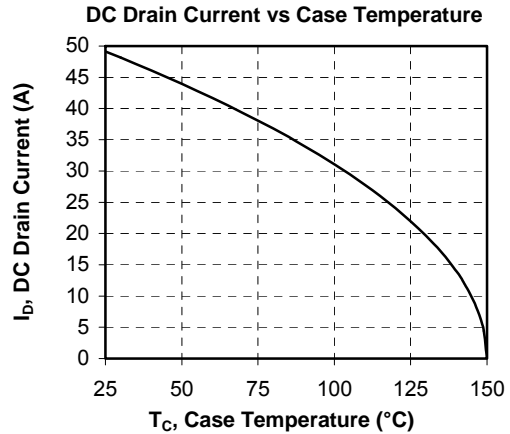
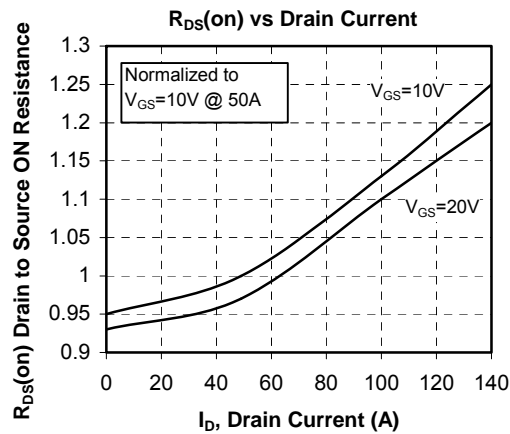
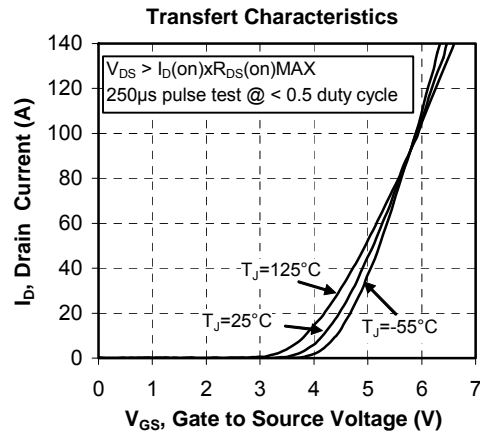
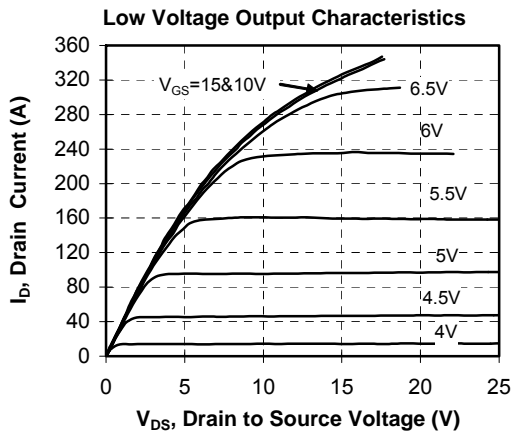
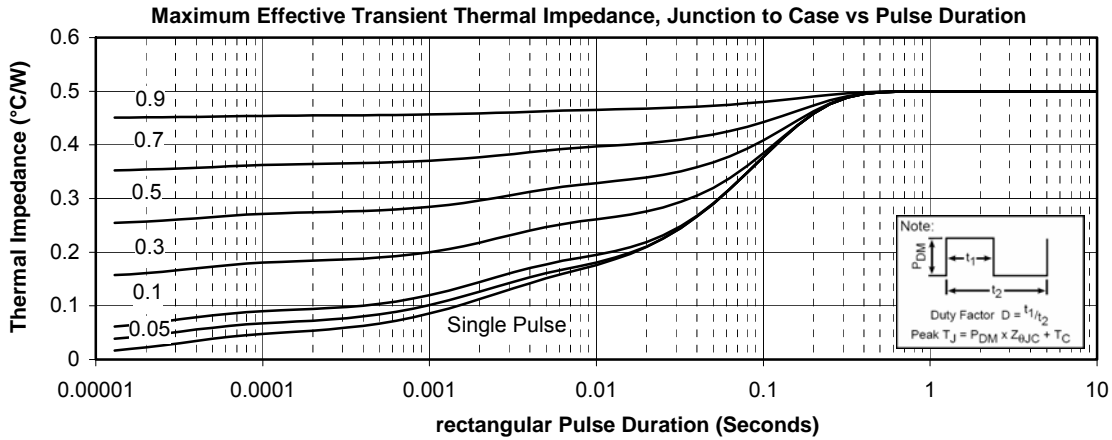

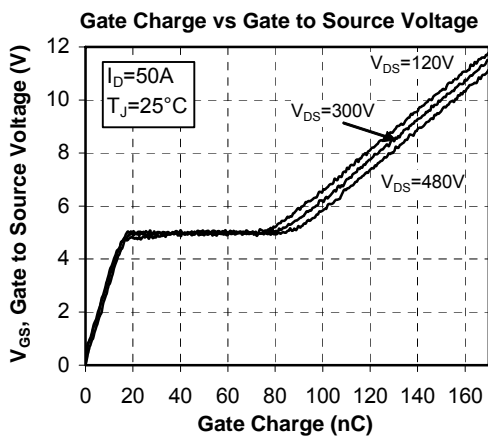
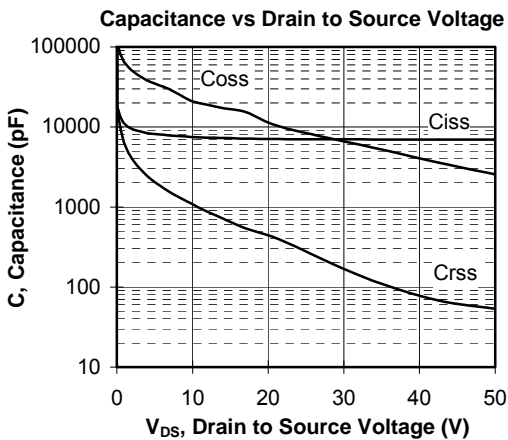
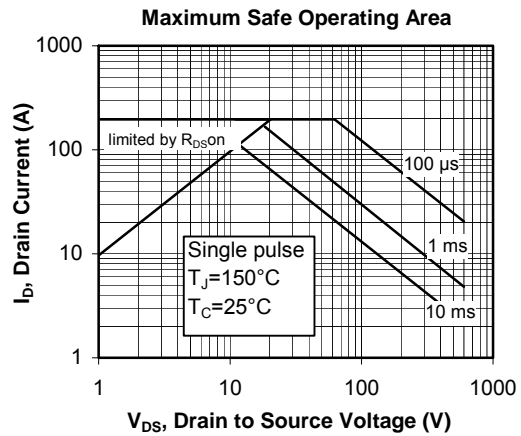
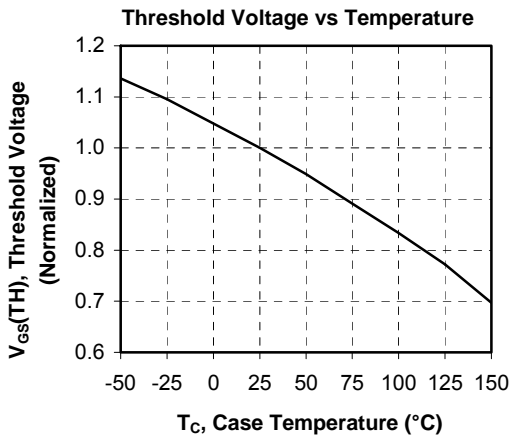
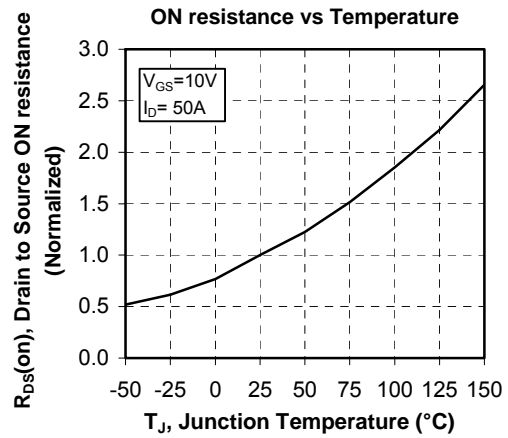
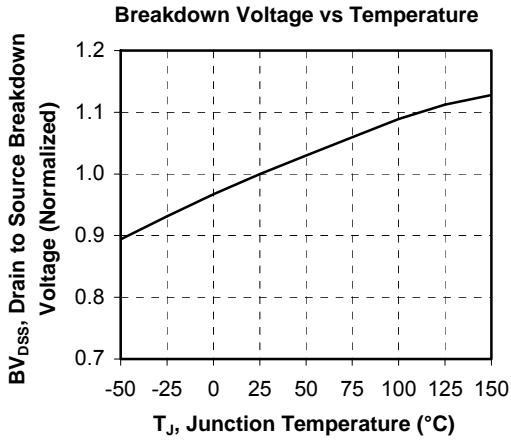

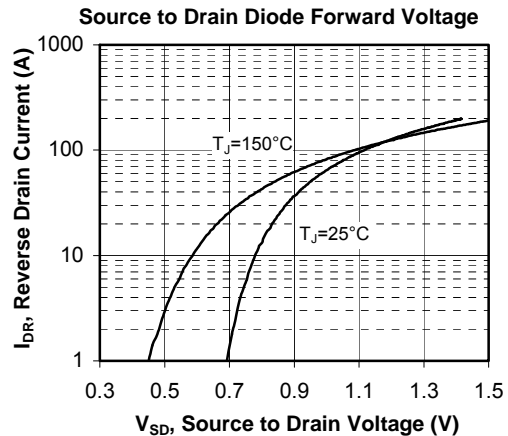
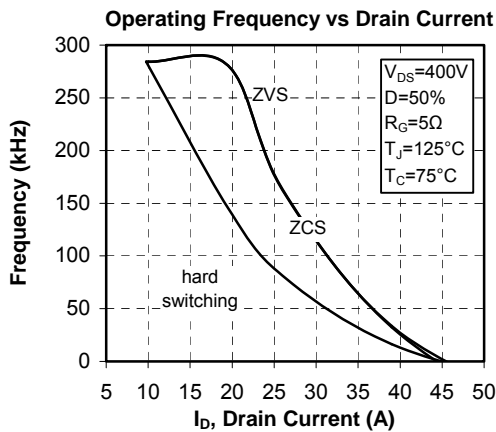
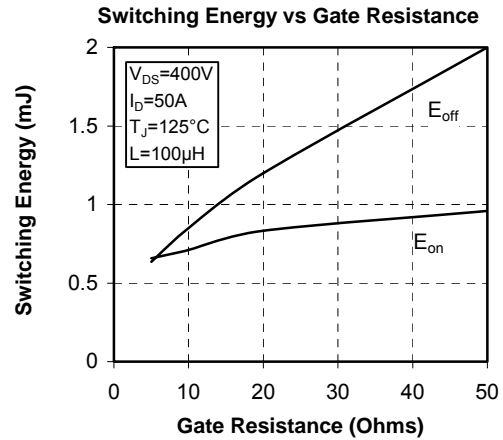
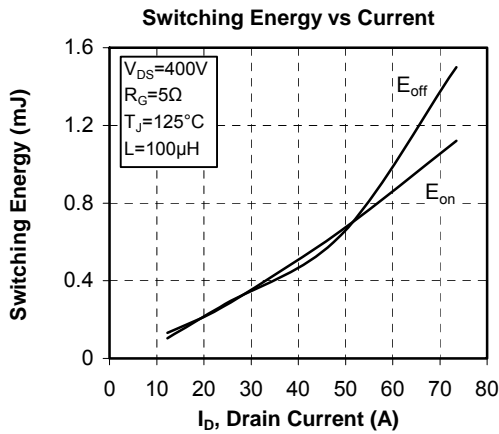
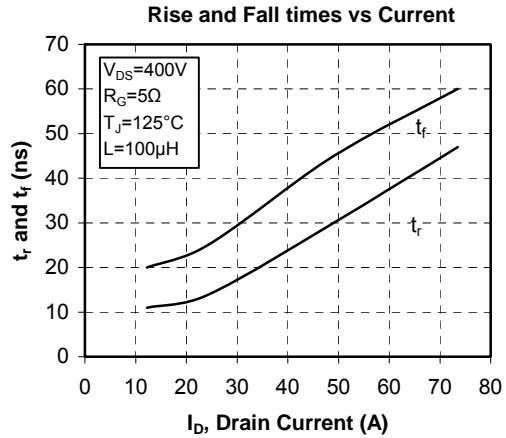
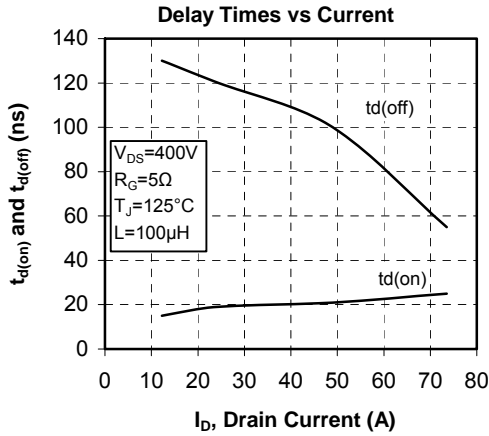

Typical SiC Diode Performance Curve

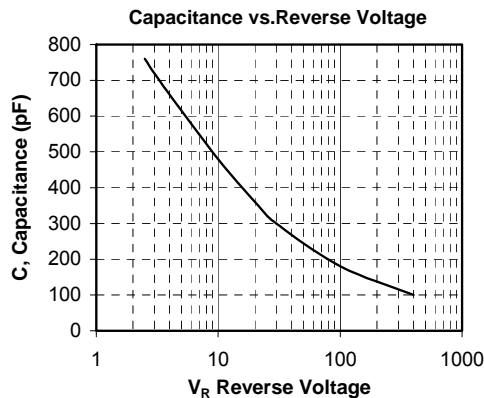
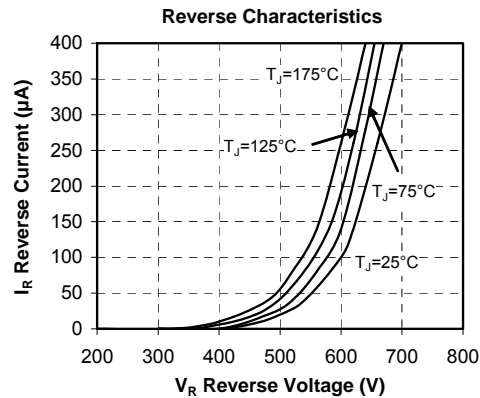
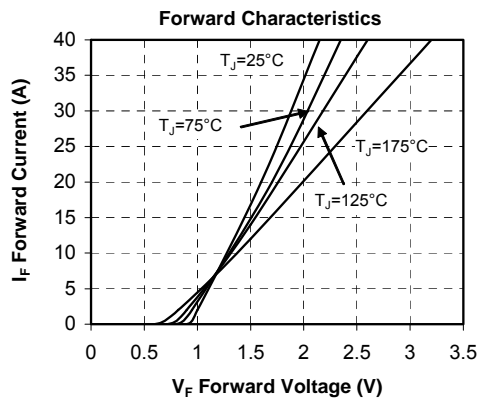
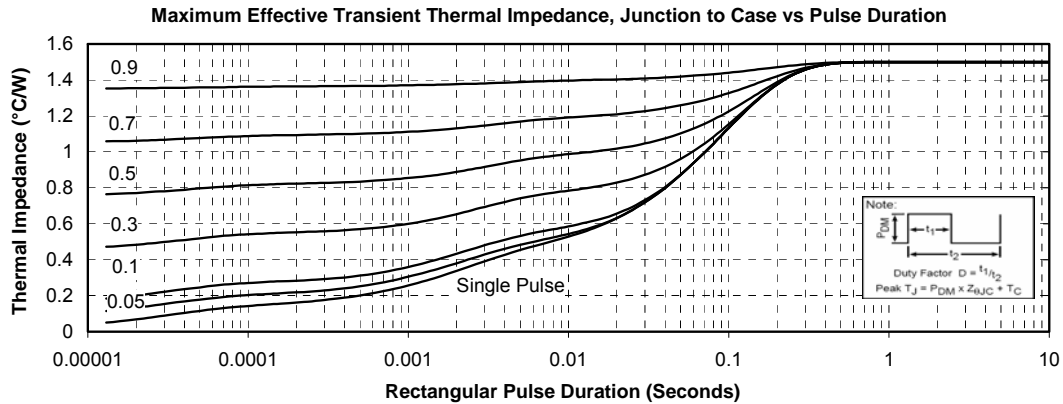

“COOLMOS™ comprise a new family of transistors developed by Infineon Technologies AG. “COOLMOS” is a trademark of Infineon Technologies AG”.

Microsemi reserves the right to change, without notice, the specifications and information contained herein

Microsemi's products are covered by one or more of U.S patents 4,895,810 5,045,903 5,089,434 5,182,234 5,019,522 5,262,336 6,503,786 5,256,583 4,748,103 5,283,202 5,231,474 5,434,095 5,528,058 6,939,743 7,352,045 5,283,201 5,801,417 5,648,283 7,196,634 6,664,594 7,157,886 6,939,743 7,342,262 and foreign patents. U.S and Foreign patents pending. All Rights Reserved.