

## POWER MOS 7® FREDFET

Power MOS 7® is a new generation of low loss, high voltage, N-Channel enhancement mode power MOSFETS. Both conduction and switching losses are addressed with Power MOS 7® by significantly lowering  $R_{DS(ON)}$  and  $Q_g$ . Power MOS 7® combines lower conduction and switching losses along with exceptionally fast switching speeds inherent with APT's patented metal gate structure.



- Lower Input Capacitance
  - Lower Miller Capacitance
  - Lower Gate Charge,  $Q_g$
- Increased Power Dissipation
  - Easier To Drive
  - Popular SOT-227 Package

**FAST RECOVERY BODY DIODE**

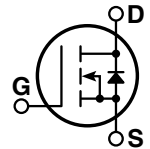

### MAXIMUM RATINGS

All Ratings:  $T_C = 25^\circ\text{C}$  unless otherwise specified.

Symbol	Parameter	APT30M17JFLL	UNIT
$V_{DSS}$	Drain-Source Voltage	300	Volts
$I_D$	Continuous Drain Current @ $T_C = 25^\circ\text{C}$	135	Amps
$I_{DM}$	Pulsed Drain Current <sup>①</sup>	540	
$V_{GS}$	Gate-Source Voltage Continuous	$\pm 30$	Volts
$V_{GSM}$	Gate-Source Voltage Transient	$\pm 40$	
$P_D$	Total Power Dissipation @ $T_C = 25^\circ\text{C}$	694	Watts
	Linear Derating Factor	5.56	W/ $^\circ\text{C}$
$T_J, T_{STG}$	Operating and Storage Junction Temperature Range	-55 to 150	$^\circ\text{C}$
$T_L$	Lead Temperature: 0.063" from Case for 10 Sec.	300	
$I_{AR}$	Avalanche Current <sup>①</sup> (Repetitive and Non-Repetitive)	135	Amps
$E_{AR}$	Repetitive Avalanche Energy <sup>①</sup>	50	mJ
$E_{AS}$	Single Pulse Avalanche Energy <sup>④</sup>	3600	

### STATIC ELECTRICAL CHARACTERISTICS

Symbol	Characteristic / Test Conditions	MIN	TYP	MAX	UNIT
$BV_{DSS}$	Drain-Source Breakdown Voltage ( $V_{GS} = 0V, I_D = 250\mu\text{A}$ )	300			Volts
$R_{DS(on)}$	Drain-Source On-State Resistance <sup>②</sup> ( $V_{GS} = 10V, I_D = 67.5A$ )			0.017	Ohms
$I_{DSS}$	Zero Gate Voltage Drain Current ( $V_{DS} = 300V, V_{GS} = 0V$ )			250	$\mu\text{A}$
	Zero Gate Voltage Drain Current ( $V_{DS} = 240V, V_{GS} = 0V, T_C = 125^\circ\text{C}$ )			1000	
$I_{GSS}$	Gate-Source Leakage Current ( $V_{GS} = \pm 30V, V_{DS} = 0V$ )			$\pm 100$	nA
$V_{GS(th)}$	Gate Threshold Voltage ( $V_{DS} = V_{GS}, I_D = 5mA$ )	3		5	Volts

 **CAUTION:** These Devices are Sensitive to Electrostatic Discharge. Proper Handling Procedures Should Be Followed.

APT Website - <http://www.advancedpower.com>

**DYNAMIC CHARACTERISTICS**

**APT30M17JFL**

Symbol	Characteristic	Test Conditions	MIN	TYP	MAX	UNIT
$C_{iss}$	Input Capacitance	$V_{GS} = 0V$ $V_{DS} = 25V$ $f = 1\text{ MHz}$		14100		pF
$C_{oss}$	Output Capacitance			3285		
$C_{rss}$	Reverse Transfer Capacitance			185		
$Q_g$	Total Gate Charge ③	$V_{GS} = 10V$ $V_{DD} = 150V$ $I_D = 135A @ 25^\circ C$		230		nC
$Q_{gs}$	Gate-Source Charge			85		
$Q_{gd}$	Gate-Drain ("Miller") Charge			105		
$t_{d(on)}$	Turn-on Delay Time	<b>RESISTIVE SWITCHING</b> $V_{GS} = 15V$ $V_{DD} = 150V$ $I_D = 135A @ 25^\circ C$ $R_G = 0.6\Omega$		19		ns
$t_r$	Rise Time			31		
$t_{d(off)}$	Turn-off Delay Time			44		
$t_f$	Fall Time			13		
$E_{on}$	Turn-on Switching Energy ⑥	<b>INDUCTIVE SWITCHING @ 25°C</b> $V_{DD} = 200V, V_{GS} = 15V$ $I_D = 100A, R_G = 5\Omega$		1120		$\mu J$
$E_{off}$	Turn-off Switching Energy			1250		
$E_{on}$	Turn-on Switching Energy ⑥	<b>INDUCTIVE SWITCHING @ 125°C</b> $V_{DD} = 200V, V_{GS} = 15V$ $I_D = 100A, R_G = 5\Omega$		1325		
$E_{off}$	Turn-off Switching Energy			1460		

**SOURCE-DRAIN DIODE RATINGS AND CHARACTERISTICS**

Symbol	Characteristic / Test Conditions	MIN	TYP	MAX	UNIT
$I_S$	Continuous Source Current (Body Diode)			135	Amps
$I_{SM}$	Pulsed Source Current ① (Body Diode)			540	
$V_{SD}$	Diode Forward Voltage ② ( $V_{GS} = 0V, I_S = -135A$ )			1.3	Volts
$dv/dt$	Peak Diode Recovery $dv/dt$ ⑤			8	V/ns
$t_{rr}$	Reverse Recovery Time ( $I_S = -135A, di/dt = 100A/\mu s$ )	$T_j = 25^\circ C$	200	300	ns
		$T_j = 125^\circ C$	250	525	
$Q_{rr}$	Reverse Recovery Charge ( $I_S = -135A, di/dt = 100A/\mu s$ )	$T_j = 25^\circ C$	1.5		$\mu C$
		$T_j = 125^\circ C$	4.4		
$I_{RRM}$	Peak Recovery Current ( $I_S = -135A, di/dt = 100A/\mu s$ )	$T_j = 25^\circ C$	15		Amps
		$T_j = 125^\circ C$	25		

**THERMAL CHARACTERISTICS**

Symbol	Characteristic	MIN	TYP	MAX	UNIT
$R_{\theta JC}$	Junction to Case			0.18	$^\circ C/W$
$R_{\theta JA}$	Junction to Ambient			40	

① Repetitive Rating: Pulse width limited by maximum junction temperature

② Pulse Test: Pulse width < 380  $\mu s$ , Duty Cycle < 2%

③ See MIL-STD-750 Method 3471

④ Starting  $T_j = +25^\circ C$ ,  $L = .40mH$ ,  $R_G = 25\Omega$ , Peak  $I_L = 135A$

⑤  $dv/dt$  numbers reflect the limitations of the test circuit rather than the device itself.  $I_S \leq I_D - 135A$   $di/dt \leq 700A/\mu s$   $V_R \leq 300$   $T_j \leq 150^\circ C$

⑥  $E_{on}$  includes diode reverse recovery. See figures 18, 20.

APT Reserves the right to change, without notice, the specifications and information contained herein.

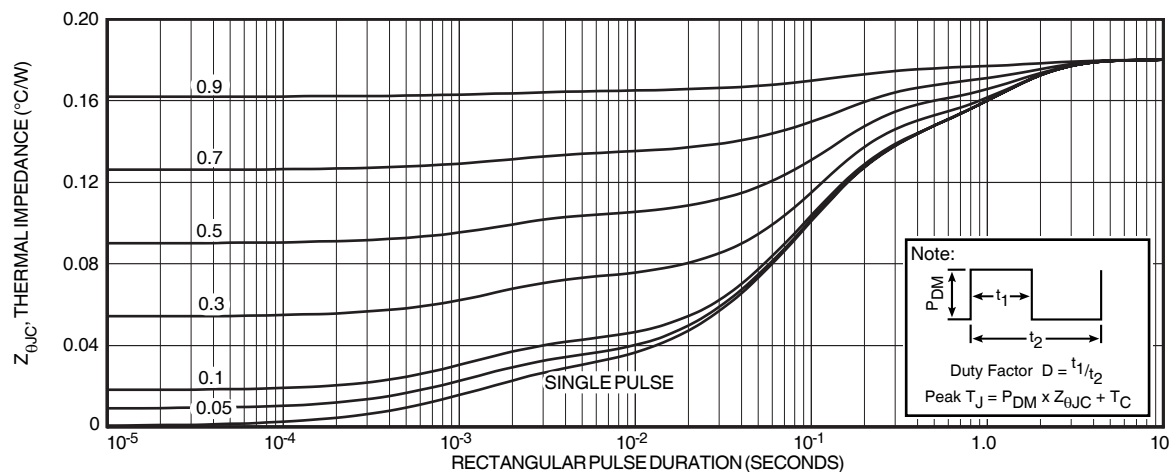

FIGURE 1, MAXIMUM EFFECTIVE TRANSIENT THERMAL IMPEDANCE, JUNCTION-TO-CASE vs PULSE DURATION

Typical Performance Curves

APT30M17JFLL

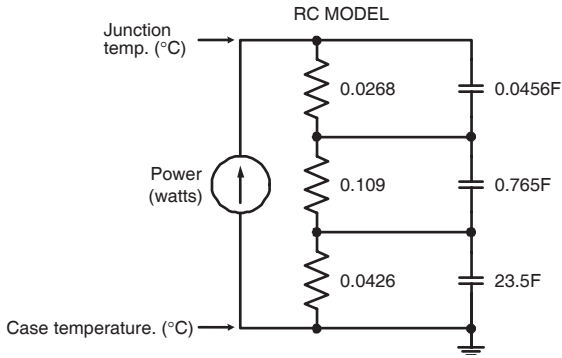

FIGURE 2, TRANSIENT THERMAL IMPEDANCE MODEL

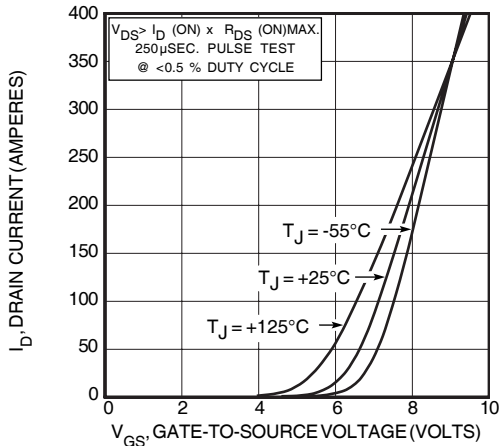

FIGURE 4, TRANSFER CHARACTERISTICS

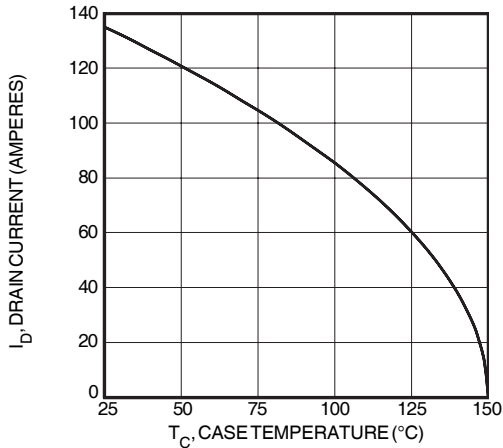

FIGURE 6, MAXIMUM DRAIN CURRENT vs CASE TEMPERATURE

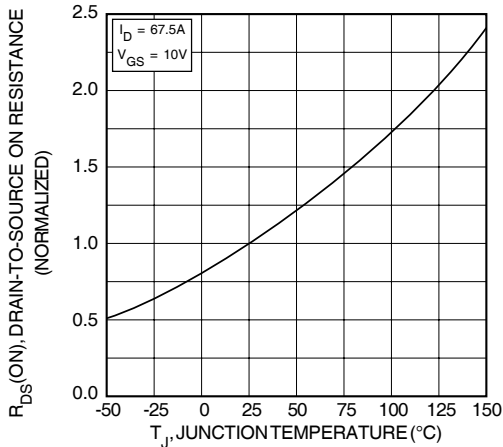

FIGURE 8, ON-RESISTANCE vs. TEMPERATURE

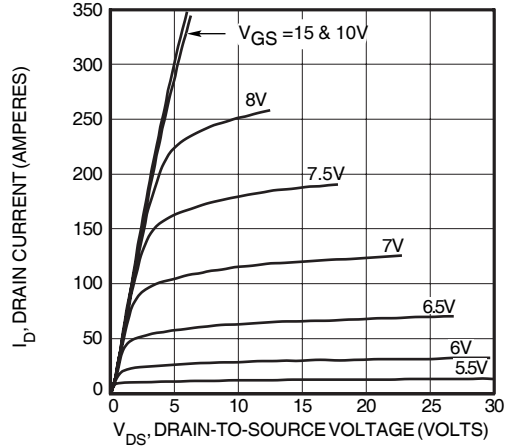

FIGURE 3, LOW VOLTAGE OUTPUT CHARACTERISTICS

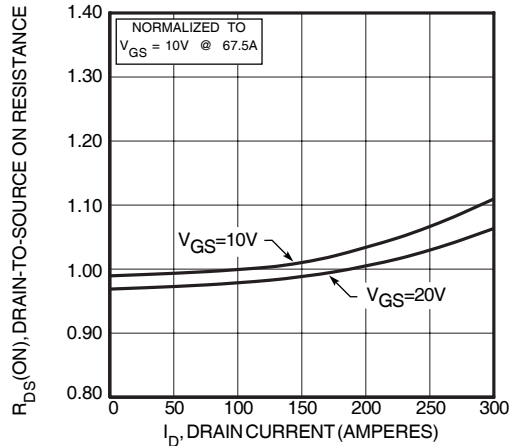

FIGURE 5,  $R_{DS}(ON)$  vs DRAIN CURRENT

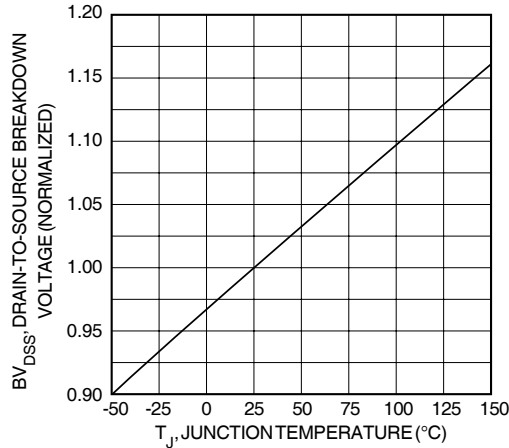

FIGURE 7, BREAKDOWN VOLTAGE vs TEMPERATURE

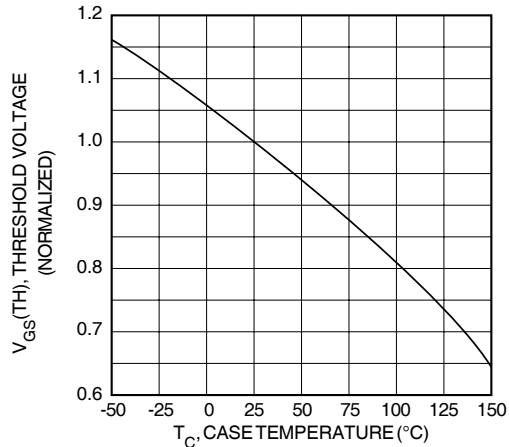

FIGURE 9, THRESHOLD VOLTAGE vs TEMPERATURE

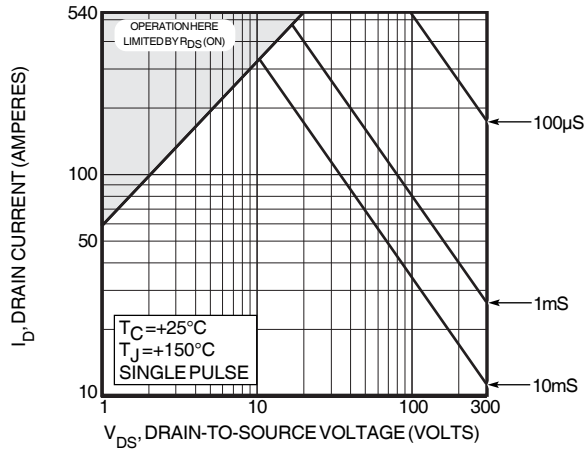

FIGURE 10, MAXIMUM SAFE OPERATING AREA

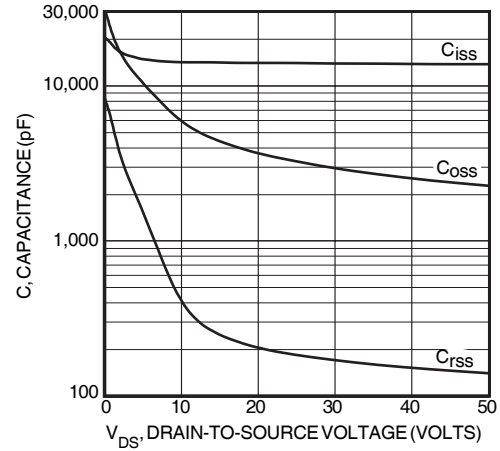

FIGURE 11, CAPACITANCE vs DRAIN-TO-SOURCE VOLTAGE

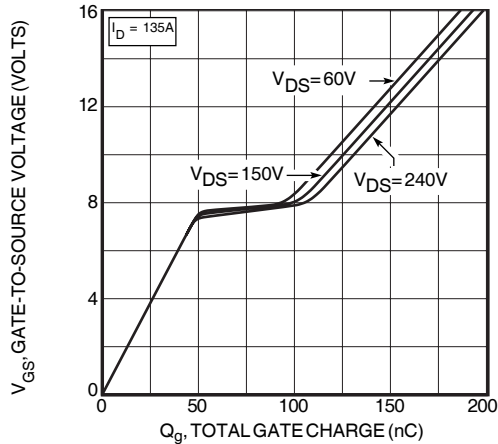

FIGURE 12, GATE CHARGES vs GATE-TO-SOURCE VOLTAGE

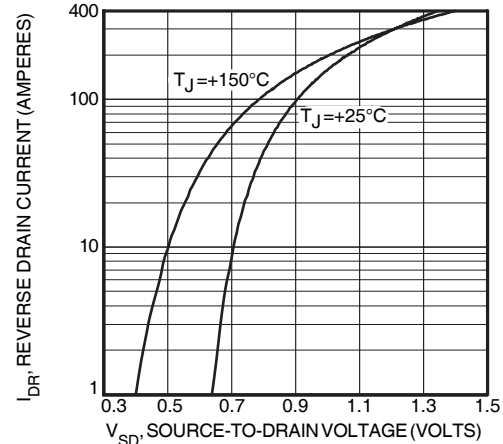

FIGURE 13, SOURCE-DRAIN DIODE FORWARD VOLTAGE

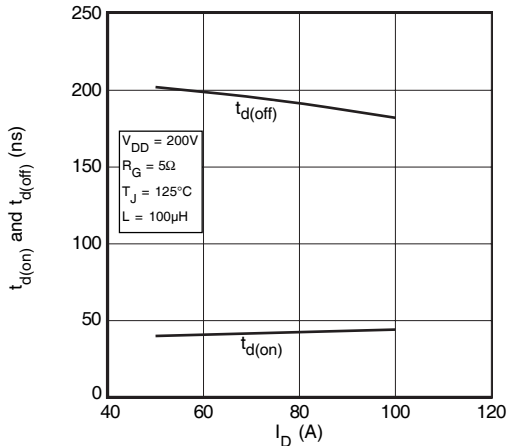

FIGURE 14, DELAY TIMES vs CURRENT

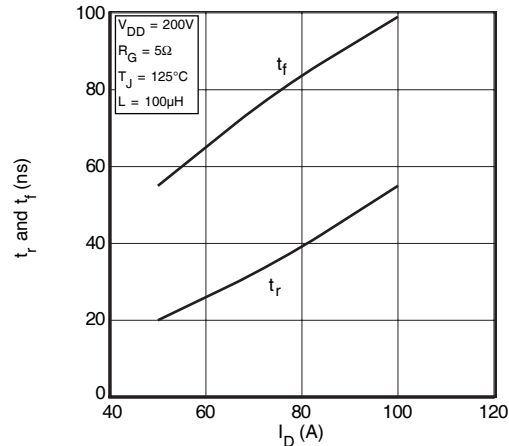

FIGURE 15, RISE AND FALL TIMES vs CURRENT

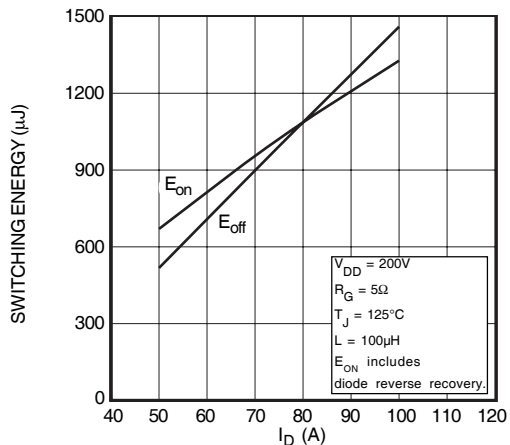

FIGURE 16, SWITCHING ENERGY vs CURRENT

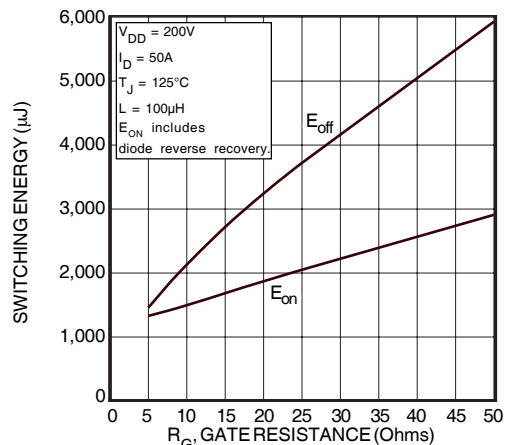

FIGURE 17, SWITCHING ENERGY vs. GATE RESISTANCE

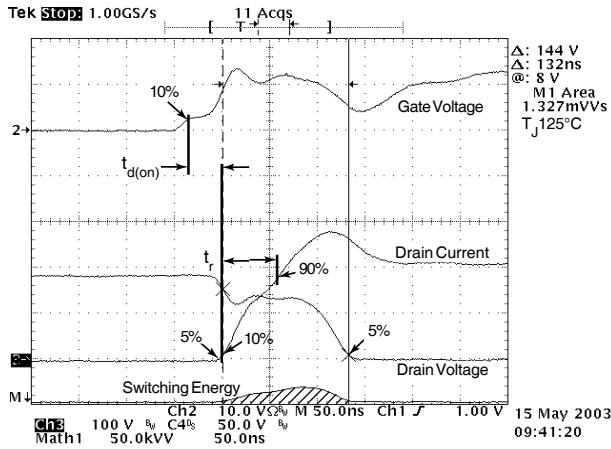

Figure 18, Turn-on Switching Waveforms and Definitions

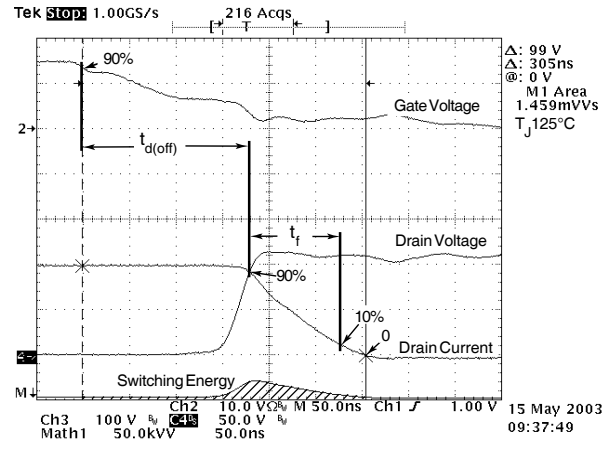

Figure 19, Turn-off Switching Waveforms and Definitions

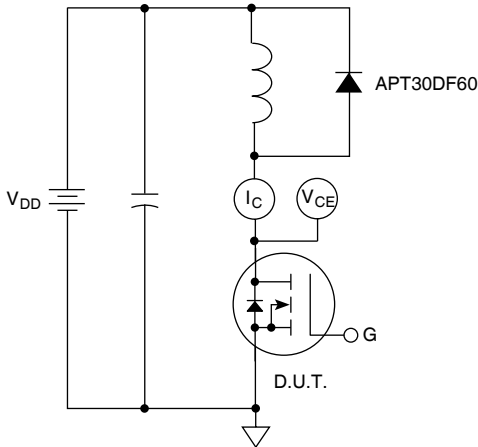
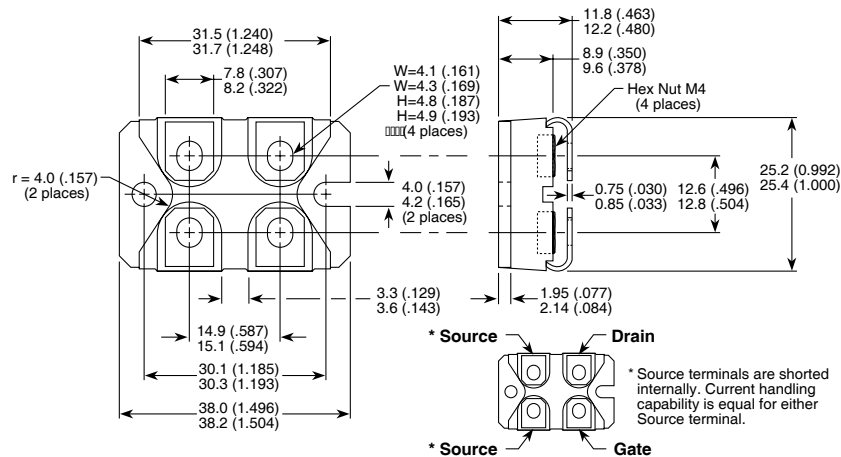

Figure 20, Inductive Switching Test Circuit

SOT-227 (ISOTOP®) Package Outline



Dimensions in Millimeters and (Inches)