

Full - Bridge MOSFET Power Module

$V_{DSS} = 200V$
 $R_{DSon} = 10m\Omega \text{ typ @ } T_j = 25^\circ C$
 $I_D = 175A \text{ @ } T_c = 25^\circ C$

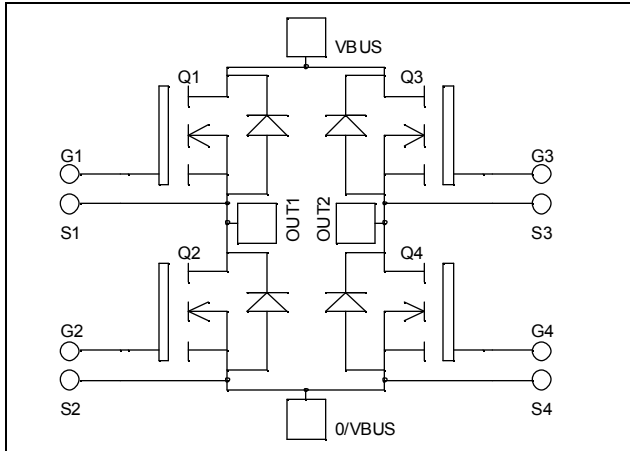

Application

- Welding converters
- Switched Mode Power Supplies
- Uninterruptible Power Supplies
- Motor control

Features

- Power MOS 7[®] FREDFETs
 - Low R_{DSon}
 - Low input and Miller capacitance
 - Low gate charge
 - Fast intrinsic reverse diode
 - Avalanche energy rated
 - Very rugged
- Kelvin source for easy drive
- Very low stray inductance
 - Symmetrical design
 - M5 power connectors
- High level of integration

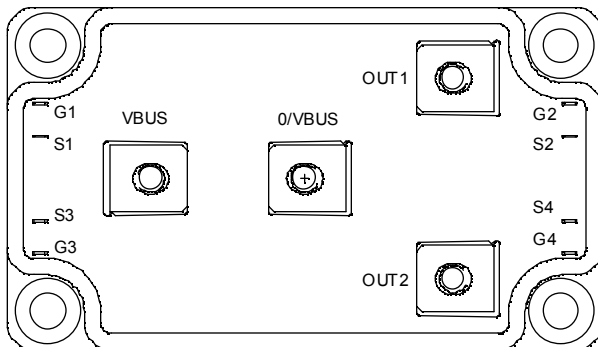

Benefits

- Outstanding performance at high frequency operation
- Direct mounting to heatsink (isolated package)
- Low junction to case thermal resistance
- Low profile
- RoHS Compliant

Absolute maximum ratings

Symbol	Parameter	Max ratings	Unit
V_{DSS}	Drain - Source Breakdown Voltage	200	V
I_D	Continuous Drain Current	$T_c = 25^\circ C$	175
		$T_c = 80^\circ C$	131
I_{DM}	Pulsed Drain current	700	
V_{GS}	Gate - Source Voltage	± 30	V
R_{DSon}	Drain - Source ON Resistance	12	$m\Omega$
P_D	Maximum Power Dissipation	$T_c = 25^\circ C$	694
I_{AR}	Avalanche current (repetitive and non repetitive)	89	A
E_{AR}	Repetitive Avalanche Energy	50	mJ
E_{AS}	Single Pulse Avalanche Energy	2500	

CAUTION: These Devices are sensitive to Electrostatic Discharge. Proper Handling Procedures Should Be Followed. See application note APT0502 on www.microsemi.com

All ratings @ $T_j = 25^\circ\text{C}$ unless otherwise specified

Electrical Characteristics

Symbol	Characteristic	Test Conditions	Min	Typ	Max	Unit
I_{DSS}	Zero Gate Voltage Drain Current	$V_{GS} = 0\text{V}, V_{DS} = 200\text{V}$			200	μA
		$V_{GS} = 0\text{V}, V_{DS} = 160\text{V}$			1000	
$R_{DS(on)}$	Drain – Source on Resistance	$V_{GS} = 10\text{V}, I_D = 87.5\text{A}$		10	12	$\text{m}\Omega$
$V_{GS(th)}$	Gate Threshold Voltage	$V_{GS} = V_{DS}, I_D = 5\text{mA}$	3		5	V
I_{GSS}	Gate – Source Leakage Current	$V_{GS} = \pm 30\text{V}, V_{DS} = 0\text{V}$			± 150	nA

Dynamic Characteristics

Symbol	Characteristic	Test Conditions	Min	Typ	Max	Unit
C_{iss}	Input Capacitance	$V_{GS} = 0\text{V}$		13.7		nF
C_{oss}	Output Capacitance	$V_{DS} = 25\text{V}$		4.36		
C_{rss}	Reverse Transfer Capacitance	$f = 1\text{MHz}$		0.19		
Q_g	Total gate Charge	$V_{GS} = 10\text{V}$		224		nC
Q_{gs}	Gate – Source Charge	$V_{Bus} = 100\text{V}$		86		
Q_{gd}	Gate – Drain Charge	$I_D = 150\text{A}$		94		
$T_{d(on)}$	Turn-on Delay Time	Inductive switching @ 125°C $V_{GS} = 15\text{V}$ $V_{Bus} = 133\text{V}$ $I_D = 150\text{A}$ $R_G = 2.5\Omega$		28		ns
T_r	Rise Time			56		
$T_{d(off)}$	Turn-off Delay Time			81		
T_f	Fall Time			99		
E_{on}	Turn-on Switching Energy	Inductive switching @ 25°C $V_{GS} = 15\text{V}, V_{Bus} = 133\text{V}$ $I_D = 150\text{A}, R_G = 2.5\Omega$		926		μJ
E_{off}	Turn-off Switching Energy			910		
E_{on}	Turn-on Switching Energy	Inductive switching @ 125°C $V_{GS} = 15\text{V}, V_{Bus} = 133\text{V}$ $I_D = 150\text{A}, R_G = 2.5\Omega$		1216		μJ
E_{off}	Turn-off Switching Energy			1062		

Source - Drain diode ratings and characteristics

Symbol	Characteristic	Test Conditions	Min	Typ	Max	Unit	
I_S	Continuous Source current (Body diode)	$T_c = 25^\circ\text{C}$			175	A	
		$T_c = 80^\circ\text{C}$			131		
V_{SD}	Diode Forward Voltage	$V_{GS} = 0\text{V}, I_S = -150\text{A}$			1.3	V	
dv/dt	Peak Diode Recovery ①				8	V/ns	
t_{rr}	Reverse Recovery Time	$I_S = -150\text{A}$ $V_R = 133\text{V}$ $di/dt = 200\text{A}/\mu\text{s}$	$T_j = 25^\circ\text{C}$			220	ns
			$T_j = 125^\circ\text{C}$			420	
Q_{rr}	Reverse Recovery Charge	$I_S = -150\text{A}$ $V_R = 133\text{V}$ $di/dt = 200\text{A}/\mu\text{s}$	$T_j = 25^\circ\text{C}$		2.14	μC	
			$T_j = 125^\circ\text{C}$		5.8		

 ① dv/dt numbers reflect the limitations of the circuit rather than the device itself.

$$I_S \leq -150\text{A} \quad di/dt \leq 700\text{A}/\mu\text{s} \quad V_R \leq V_{DSS} \quad T_j \leq 150^\circ\text{C}$$

Thermal and package characteristics

Symbol Characteristic

		<i>Min</i>	<i>Typ</i>	<i>Max</i>	<i>Unit</i>	
R_{thJC}	Junction to Case Thermal Resistance			0.18	°C/W	
V_{ISOL}	RMS Isolation Voltage, any terminal to case t = 1 min, I isol < 1mA, 50/60Hz	2500			V	
T_J	Operating junction temperature range	-40		150	°C	
T_{STG}	Storage Temperature Range	-40		125		
T_C	Operating Case Temperature	-40		100		
Torque	Mounting torque	To heatsink	M6	3	5	N.m
		For terminals	M5	2	3.5	
Wt	Package Weight			280	g	

SP6 Package outline (dimensions in mm)

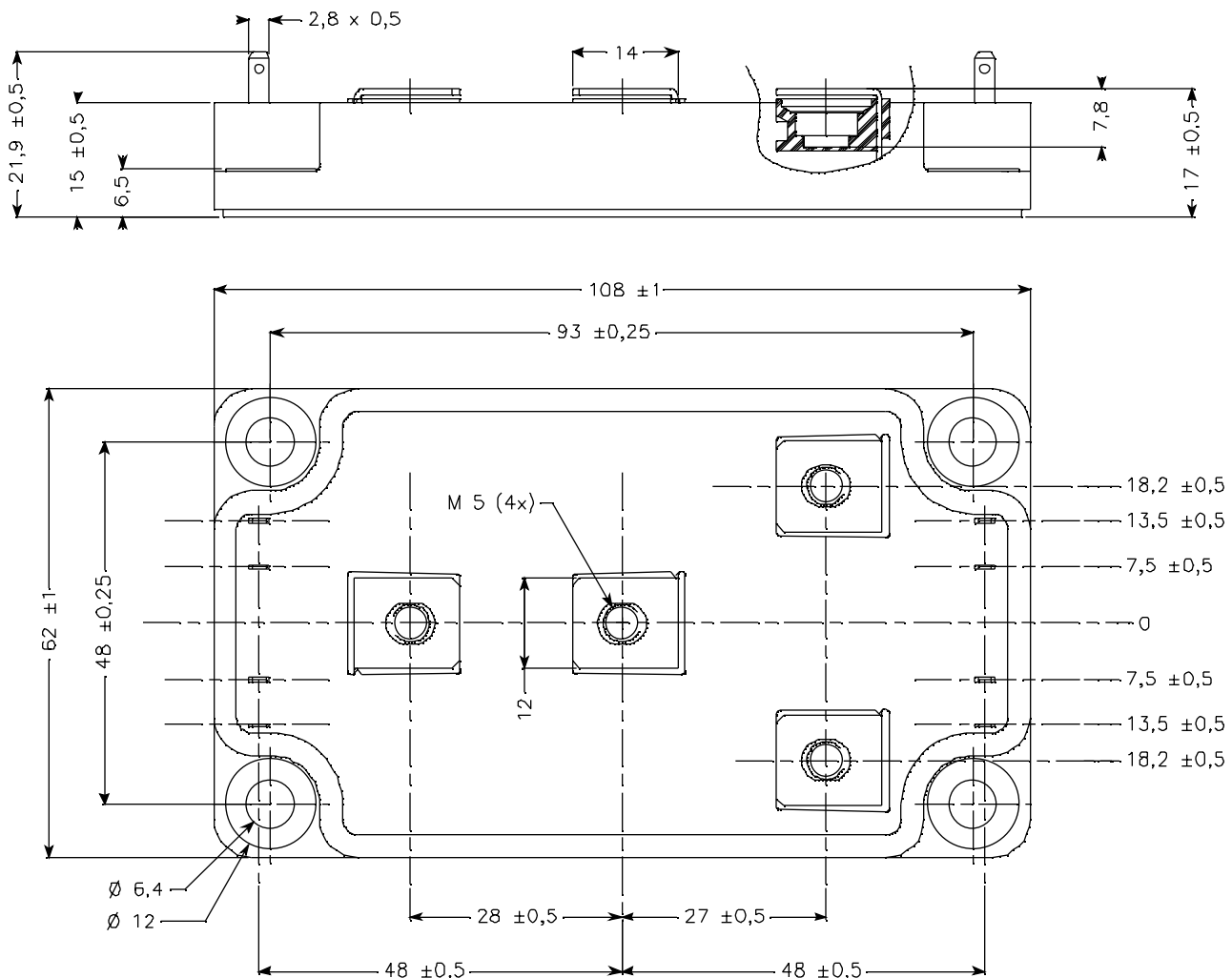

See application note APT0601 - Mounting Instructions for SP6 Power Modules on www.microsemi.com

Typical Performance Curve

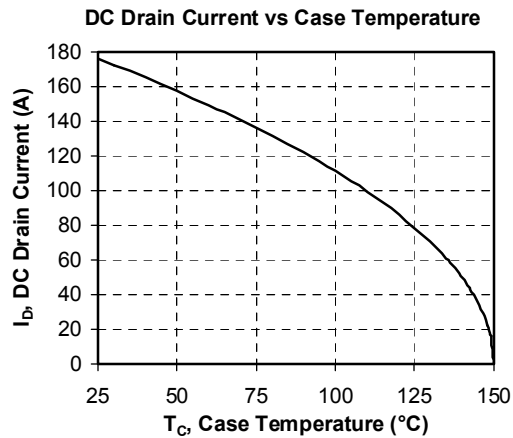
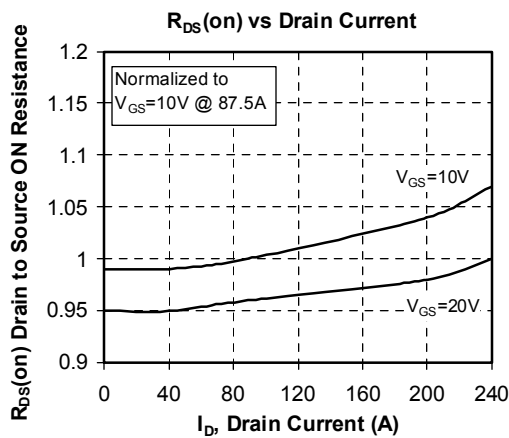
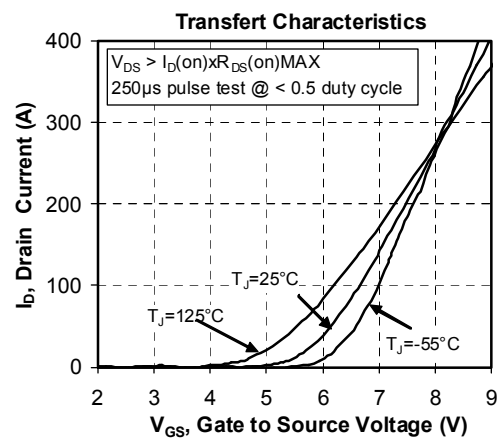
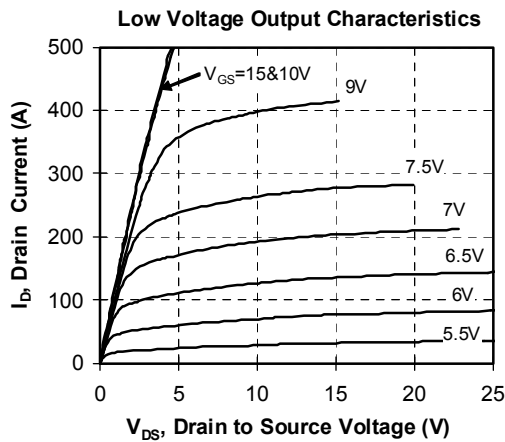
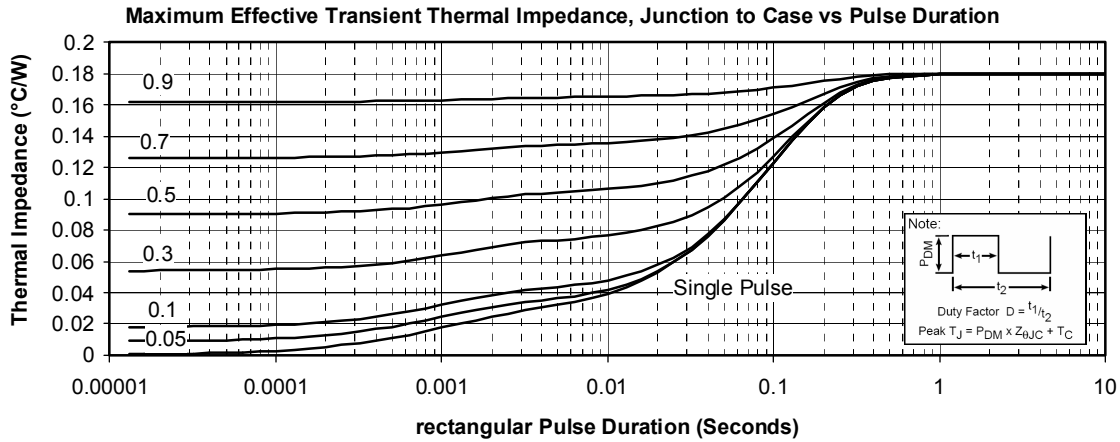

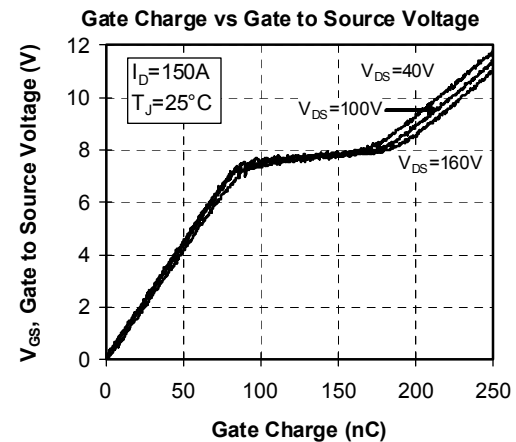
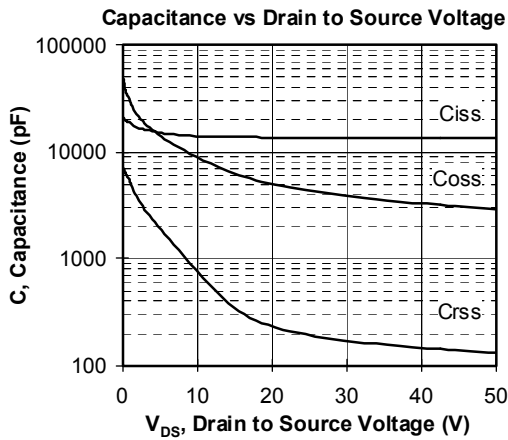
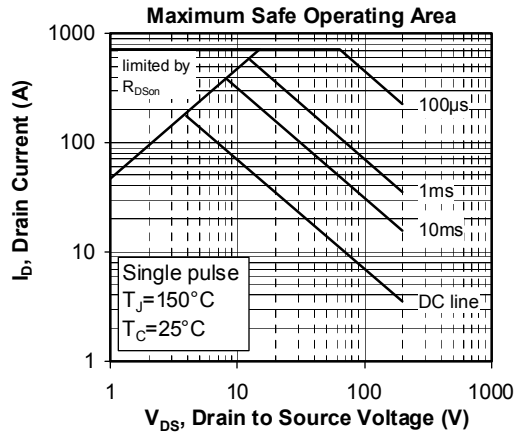
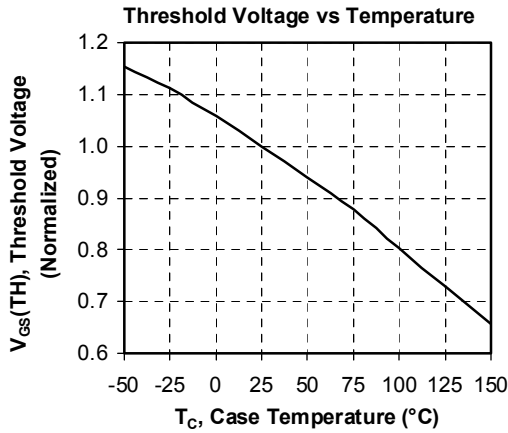
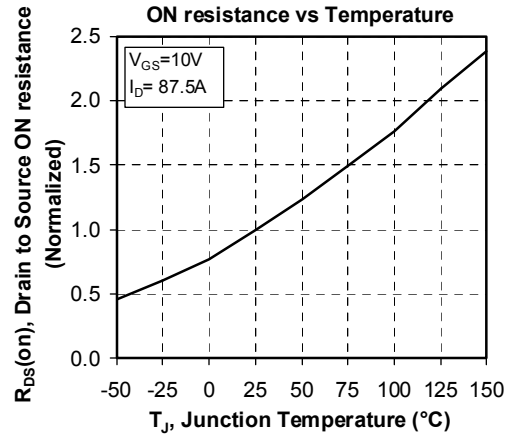
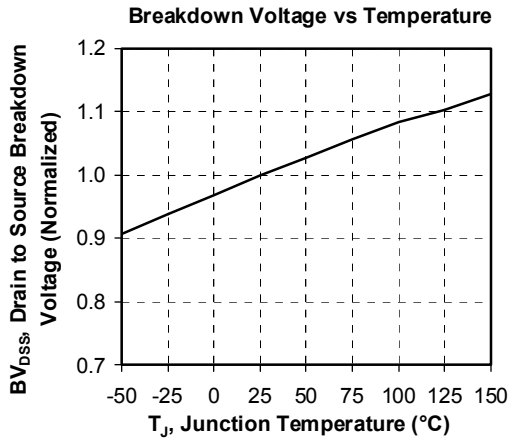

Delay Times vs Current

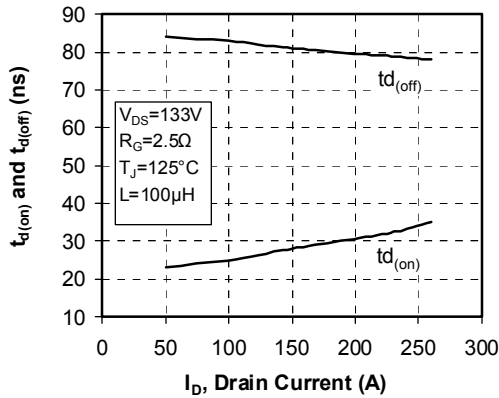

Rise and Fall times vs Current

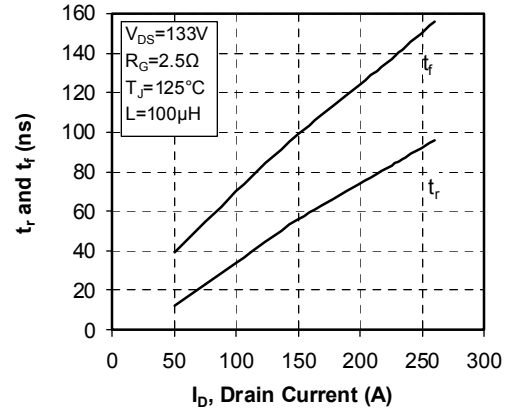

Switching Energy vs Current

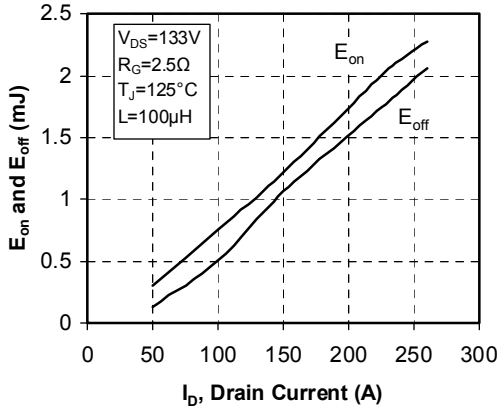

Switching Energy vs Gate Resistance

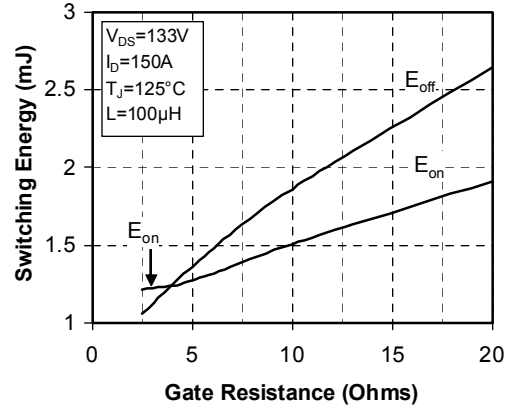

Operating Frequency vs Drain Current

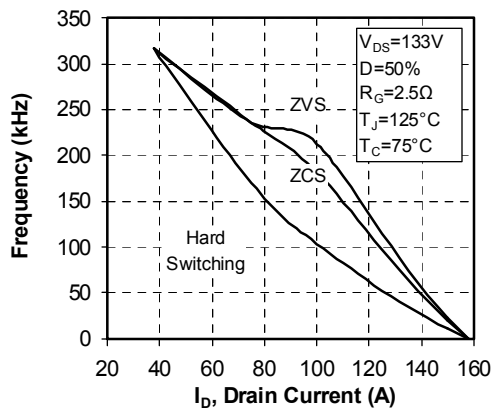

Source to Drain Diode Forward Voltage

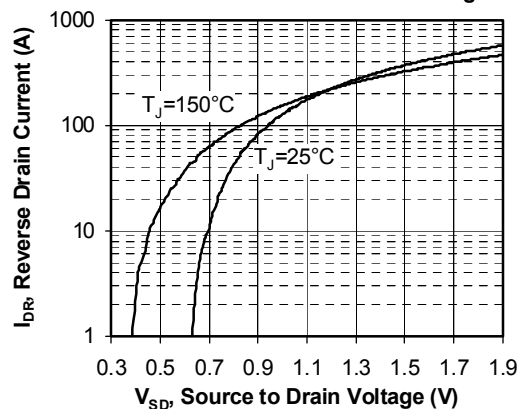

Microsemi reserves the right to change, without notice, the specifications and information contained herein

Microsemi's products are covered by one or more of U.S. patents 4,895,810 5,045,903 5,089,434 5,182,234 5,019,522 5,262,336 6,503,786 5,256,583 4,748,103 5,283,202 5,231,474 5,434,095 5,528,058 and foreign patents. U.S. and Foreign patents pending. All Rights Reserved.

