

**Boost chopper CoolMos™ + full bridge
NPT & Trench + Field Stop IGBT
Power module**

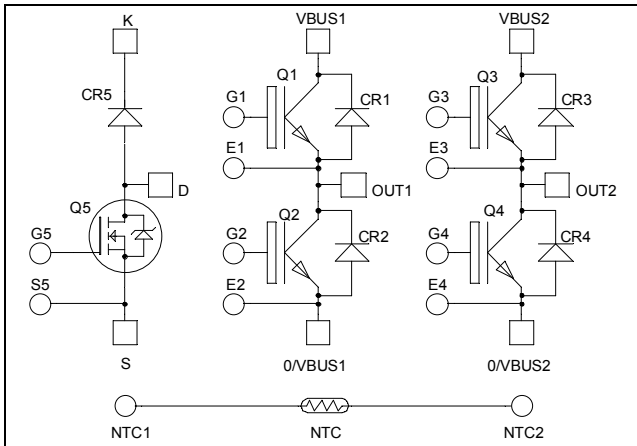

Full bridge top switches : Trench + Field Stop IGBT
Full bridge bottom switches : FAST NPT IGBT
Q5 boost chopper : CoolMOS™

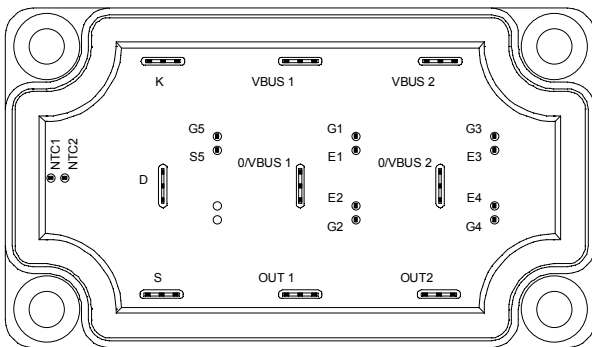

Trench & Field Stop IGBT Q1, Q3:
 $V_{CES} = 600V$; $I_C = 100A$ @ $T_c = 80^\circ C$

Fast NPT IGBT Q2, Q4:
 $V_{CES} = 600V$; $I_C = 100A$ @ $T_c = 80^\circ C$

CoolMOS™ Q5:
 $V_{CES} = 600V$; $I_C = 95A$ @ $T_c = 25^\circ C$

Application

- Solar converter

Features

- **Q2, Q4 (FAST Non Punch Through (NPT) IGBT)**
 - Switching frequency up to 100 kHz
 - RBSOA & SCSOA rated
 - Low tail current
- **Q1, Q3 (Trench & Field Stop IGBT)**
 - Low voltage drop
 - Switching frequency up to 20 kHz
 - RBSOA & SCSOA rated
 - Low tail current

Q5 (CoolMOS™)

- Ultra low R_{DSon}
- Low Miller capacitance
- Ultra low gate charge
- Avalanche energy rated

- Kelvin emitter for easy drive
- Very low stray inductance
- High level of integration
- Internal thermistor for temperature monitoring

Benefits

- Optimized conduction & switching losses
- Direct mounting to heatsink (isolated package)
- Low junction to case thermal resistance
- Solderable terminals both for power and signal for easy PCB mounting
- Low profile
- Easy paralleling due to positive T_c of V_{CEsat}
- RoHS Compliant

CAUTION: These Devices are sensitive to Electrostatic Discharge. Proper Handling Procedures Should Be Followed. See application note APT0502 on www.microsemi.com

All ratings @ $T_j = 25^\circ\text{C}$ unless otherwise specified

1. Full bridge top switches

1.1 Top Trench + Field Stop IGBT characteristics

Absolute maximum ratings

Symbol	Parameter	Max ratings	Unit
V_{CES}	Collector - Emitter Breakdown Voltage	600	V
I_C	Continuous Collector Current	$T_C = 25^\circ\text{C}$	150
		$T_C = 80^\circ\text{C}$	100
I_{CM}	Pulsed Collector Current	$T_C = 25^\circ\text{C}$	200
V_{GE}	Gate - Emitter Voltage	± 20	V
P_D	Maximum Power Dissipation	$T_C = 25^\circ\text{C}$	340
RBSOA	Reverse Bias Safe Operating Area	$T_j = 150^\circ\text{C}$	200A @ 550V

Electrical Characteristics

Symbol	Characteristic	Test Conditions	Min	Typ	Max	Unit
I_{CES}	Zero Gate Voltage Collector Current	$V_{GE} = 0\text{V}, V_{CE} = 600\text{V}$			250	μA
$V_{CE(sat)}$	Collector Emitter Saturation Voltage	$V_{GE} = 15\text{V}$ $I_C = 100\text{A}$	$T_j = 25^\circ\text{C}$	1.5	1.9	V
			$T_j = 150^\circ\text{C}$	1.7		
$V_{GE(th)}$	Gate Threshold Voltage	$V_{GE} = V_{CE}, I_C = 1.5\text{ mA}$	5.0	5.8	6.5	V
I_{GES}	Gate - Emitter Leakage Current	$V_{GE} = 20\text{V}, V_{CE} = 0\text{V}$			400	nA

Dynamic Characteristics

Symbol	Characteristic	Test Conditions	Min	Typ	Max	Unit
C_{ies}	Input Capacitance	$V_{GE} = 0\text{V}$ $V_{CE} = 25\text{V}$ $f = 1\text{MHz}$		6100		pF
C_{oes}	Output Capacitance			390		
C_{res}	Reverse Transfer Capacitance			190		
$T_{d(on)}$	Turn-on Delay Time	Inductive Switching (25°C) $V_{GE} = \pm 15\text{V}$ $V_{Bus} = 300\text{V}$ $I_C = 100\text{A}$ $R_G = 3.3\Omega$		115		ns
T_r	Rise Time			45		
$T_{d(off)}$	Turn-off Delay Time			225		
T_f	Fall Time			55		
$T_{d(on)}$	Turn-on Delay Time	Inductive Switching (150°C) $V_{GE} = \pm 15\text{V}$ $V_{Bus} = 300\text{V}$ $I_C = 100\text{A}$ $R_G = 3.3\Omega$		130		ns
T_r	Rise Time			50		
$T_{d(off)}$	Turn-off Delay Time			300		
T_f	Fall Time			70		
E_{on}	Turn on Energy	$V_{GE} = \pm 15\text{V}$ $V_{Bus} = 300\text{V}$ $I_C = 100\text{A}$ $R_G = 3.3\Omega$	$T_j = 25^\circ\text{C}$	0.4		mJ
			$T_j = 150^\circ\text{C}$	0.875		
E_{off}	Turn off Energy	$I_C = 100\text{A}$ $R_G = 3.3\Omega$	$T_j = 25^\circ\text{C}$	2.5		mJ
			$T_j = 150^\circ\text{C}$	3.5		
R_{thJC}	Junction to Case Thermal resistance				0.44	$^\circ\text{C/W}$

1.2 Top fast diode characteristics

<i>Symbol</i>	<i>Characteristic</i>	<i>Test Conditions</i>		<i>Min</i>	<i>Typ</i>	<i>Max</i>	<i>Unit</i>
V_{RRM}	Maximum Peak Repetitive Reverse Voltage			600			V
I_{RM}	Maximum Reverse Leakage Current	$V_R=600V$	$T_j = 25^\circ C$			100	μA
			$T_j = 125^\circ C$			500	
I_F	DC Forward Current		$T_c = 80^\circ C$		100		A
V_F	Diode Forward Voltage	$I_F = 100A$			1.6	2	V
		$I_F = 200A$			2		
		$I_F = 100A$	$T_j = 125^\circ C$		1.3		
t_{rr}	Reverse Recovery Time	$I_F = 100A$	$T_j = 25^\circ C$		160		ns
			$T_j = 125^\circ C$		220		
Q_{rr}	Reverse Recovery Charge	$V_R = 400V$ $di/dt = 200A/\mu s$	$T_j = 25^\circ C$		290		nC
			$T_j = 125^\circ C$		1530		
R_{thJC}	Junction to Case Thermal resistance					0.55	$^\circ C/W$

2. Full bridge bottom switches

2.1 Bottom Fast NPT IGBT characteristics

Absolute maximum ratings

<i>Symbol</i>	<i>Parameter</i>	<i>Max ratings</i>	<i>Unit</i>
V_{CES}	Collector - Emitter Breakdown Voltage	600	V
I_C	Continuous Collector Current	$T_c = 25^\circ C$	110
		$T_c = 80^\circ C$	90
I_{CM}	Pulsed Collector Current	$T_c = 25^\circ C$	315
V_{GE}	Gate - Emitter Voltage	± 20	V
P_D	Maximum Power Dissipation	$T_c = 25^\circ C$	416
RBSOA	Reverse Bias Safe Operating Area	$T_j = 150^\circ C$	200A @ 600V

Electrical Characteristics

<i>Symbol</i>	<i>Characteristic</i>	<i>Test Conditions</i>	<i>Min</i>	<i>Typ</i>	<i>Max</i>	<i>Unit</i>
I_{CES}	Zero Gate Voltage Collector Current	$V_{GE} = 0V$ $V_{CE} = 600V$	$T_j = 25^\circ C$		250	μA
			$T_j = 125^\circ C$		500	
$V_{CE(sat)}$	Collector Emitter saturation Voltage	$V_{GE} = 15V$ $I_C = 90A$	$T_j = 25^\circ C$	2.0	2.5	V
			$T_j = 125^\circ C$	2.2		
$V_{GE(th)}$	Gate Threshold Voltage	$V_{GE} = V_{CE}, I_C = 1mA$	3		5	V
I_{GES}	Gate - Emitter Leakage Current	$V_{GE} = 20V, V_{CE} = 0V$			± 150	nA

Dynamic Characteristics

<i>Symbol</i>	<i>Characteristic</i>	<i>Test Conditions</i>		<i>Min</i>	<i>Typ</i>	<i>Max</i>	<i>Unit</i>
C_{ies}	Input Capacitance	$V_{GE} = 0V$			4300		pF
C_{oes}	Output Capacitance	$V_{CE} = 25V$			470		
C_{res}	Reverse Transfer Capacitance	$f = 1MHz$			400		
Q_g	Total gate Charge	$V_{GE} = 15V$			330		nC
Q_{ge}	Gate – Emitter Charge	$V_{Bus} = 300V$			290		
Q_{gc}	Gate – Collector Charge	$I_C = 90A$			200		
$T_{d(on)}$	Turn-on Delay Time	Inductive Switching (25°C)			26		ns
T_r	Rise Time	$V_{GE} = 15V$			25		
$T_{d(off)}$	Turn-off Delay Time	$V_{Bus} = 400V$			150		
T_f	Fall Time	$I_C = 90A$ $R_G = 5 \Omega$			30		
$T_{d(on)}$	Turn-on Delay Time	Inductive Switching (125°C)			26		ns
T_r	Rise Time	$V_{GE} = 15V$			25		
$T_{d(off)}$	Turn-off Delay Time	$V_{Bus} = 400V$			170		
T_f	Fall Time	$I_C = 90A$ $R_G = 5 \Omega$			40		
E_{on}	Turn-on Switching Energy	$V_{GE} = 15V$ $V_{Bus} = 400V$	$T_j = 125^\circ C$		4.3		mJ
E_{off}	Turn-off Switching Energy	$I_C = 90A$ $R_G = 5 \Omega$	$T_j = 125^\circ C$		3.5		
R_{thJC}	Junction to Case Thermal resistance					0.3	°C/W

2.2 Bottom diode characteristics

<i>Symbol</i>	<i>Characteristic</i>	<i>Test Conditions</i>		<i>Min</i>	<i>Typ</i>	<i>Max</i>	<i>Unit</i>
V_{RRM}	Maximum Peak Repetitive Reverse Voltage			600			V
I_{RM}	Maximum Reverse Leakage Current	$V_R = 600V$	$T_j = 25^\circ C$			250	μA
			$T_j = 125^\circ C$			500	
I_F	DC Forward Current	$T_c = 80^\circ C$			30		A
V_F	Diode Forward Voltage	$I_F = 30A$			1.6	1.8	V
		$I_F = 60A$			1.9		
		$I_F = 30A$	$T_j = 125^\circ C$		1.4		
t_{rr}	Reverse Recovery Time	$I_F = 30A$	$T_j = 25^\circ C$		85		ns
			$T_j = 125^\circ C$		160		
Q_{rr}	Reverse Recovery Charge	$V_R = 400V$ $di/dt = 200A/\mu s$	$T_j = 25^\circ C$		130		nC
			$T_j = 125^\circ C$		700		
R_{thJC}	Junction to Case Thermal resistance					1.2	°C/W

3. Boost chopper switch

3.1 CoolMOS™ characteristics

Absolute maximum ratings

Symbol	Parameter	Max ratings	Unit
V _{DSS}	Drain - Source Breakdown Voltage	600	V
I _D	Continuous Drain Current	T _c = 25°C	95
		T _c = 80°C	70
I _{DM}	Pulsed Drain current	240	A
V _{GS}	Gate - Source Voltage	±20	V
R _{DS(on)}	Drain - Source ON Resistance	23	mΩ
P _D	Maximum Power Dissipation	T _c = 25°C	460
I _{AR}	Avalanche current (repetitive and non repetitive)	15	A
E _{AR}	Repetitive Avalanche Energy	3	mJ
E _{AS}	Single Pulse Avalanche Energy	1900	

Electrical Characteristics

Symbol	Characteristic	Test Conditions	Min	Typ	Max	Unit	
I _{DSS}	Zero Gate Voltage Drain Current	V _{GS} = 0V, V _{DS} = 600V	T _j = 25°C			350	μA
		V _{GS} = 0V, V _{DS} = 600V	T _j = 125°C			600	
R _{DS(on)}	Drain - Source on Resistance	V _{GS} = 10V, I _D = 47.5A		20	23	mΩ	
V _{GS(th)}	Gate Threshold Voltage	V _{GS} = V _{DS} , I _D = 6mA	2.1	3	3.9	V	
I _{GSS}	Gate - Source Leakage Current	V _{GS} = ±20 V, V _{DS} = 0V			200	nA	

Dynamic Characteristics

Symbol	Characteristic	Test Conditions	Min	Typ	Max	Unit
C _{iss}	Input Capacitance	V _{GS} = 0V ; V _{DS} = 25V f = 1MHz		14.4		nF
C _{rss}	Reverse Transfer Capacitance			0.58		
Q _g	Total gate Charge	V _{GS} = 10V V _{Bus} = 300V I _D = 95A		300		nC
Q _{gs}	Gate - Source Charge			68		
Q _{gd}	Gate - Drain Charge			102		
T _{d(on)}	Turn-on Delay Time	Inductive Switching (125°C) V _{GS} = 10V V _{Bus} = 400V I _D = 95A R _G = 2.5Ω		21		ns
T _r	Rise Time			30		
T _{d(off)}	Turn-off Delay Time			100		
T _f	Fall Time			45		
E _{on}	Turn-on Switching Energy	Inductive switching @ 25°C V _{GS} = 10V ; V _{Bus} = 400V I _D = 95A ; R _G = 2.5Ω		1350		μJ
E _{off}	Turn-off Switching Energy			1040		
E _{on}	Turn-on Switching Energy	Inductive switching @ 125°C V _{GS} = 10V ; V _{Bus} = 400V I _D = 95A ; R _G = 2.5Ω		2192		μJ
E _{off}	Turn-off Switching Energy			1270		
R _{thJC}	Junction to Case Thermal resistance				0.27	°C/W

3.2 Chopper diode characteristics

<i>Symbol</i>	<i>Characteristic</i>	<i>Test Conditions</i>		<i>Min</i>	<i>Typ</i>	<i>Max</i>	<i>Unit</i>
V _{RRM}	Maximum Peak Repetitive Reverse Voltage			600			V
I _{RM}	Maximum Reverse Leakage Current	V _R =600V	T _j = 25°C			100	μA
			T _j = 125°C			500	
I _F	DC Forward Current	T _c = 80°C			100		A
V _F	Diode Forward Voltage	I _F = 100A			1.6	2	V
		I _F = 200A			2		
		I _F = 100A	T _j = 125°C		1.3		
t _{rr}	Reverse Recovery Time	I _F = 100A	T _j = 25°C		160		ns
			T _j = 125°C		220		
Q _{rr}	Reverse Recovery Charge	V _R = 400V di/dt = 200A/μs	T _j = 25°C		290		nC
			T _j = 125°C		1530		
R _{thJC}	Junction to Case Thermal resistance					0.55	°C/W

4. Temperature sensor

NTC (see application note APT0406 on www.microsemi.com for more information).

<i>Symbol</i>	<i>Characteristic</i>	<i>Min</i>	<i>Typ</i>	<i>Max</i>	<i>Unit</i>
R ₂₅	Resistance @ 25°C		50		kΩ
B _{25/85}	T ₂₅ = 298.15 K		3952		K

$$R_T = \frac{R_{25}}{\exp\left[B_{25/85}\left(\frac{1}{T_{25}} - \frac{1}{T}\right)\right]}$$

T: Thermistor temperature
 R_T: Thermistor value at T

5. Package characteristics

Symbol	Characteristic	Min	Typ	Max	Unit	
V _{ISOL}	RMS Isolation Voltage, any terminal to case t=1 min, I _{isol} <1mA, 50/60Hz	2500			V	
T _J	Operating junction temperature range	-40		150*	°C	
T _{STG}	Storage Temperature Range	-40		125		
T _C	Operating Case Temperature	-40		100		
Torque	Mounting torque	To heatsink	M6	2.5	4.7	N.m
Wt	Package Weight				250	g

* T_J=175°C for Trench & Field Stop IGBT

6. SP6-P Package outline (dimensions in mm)

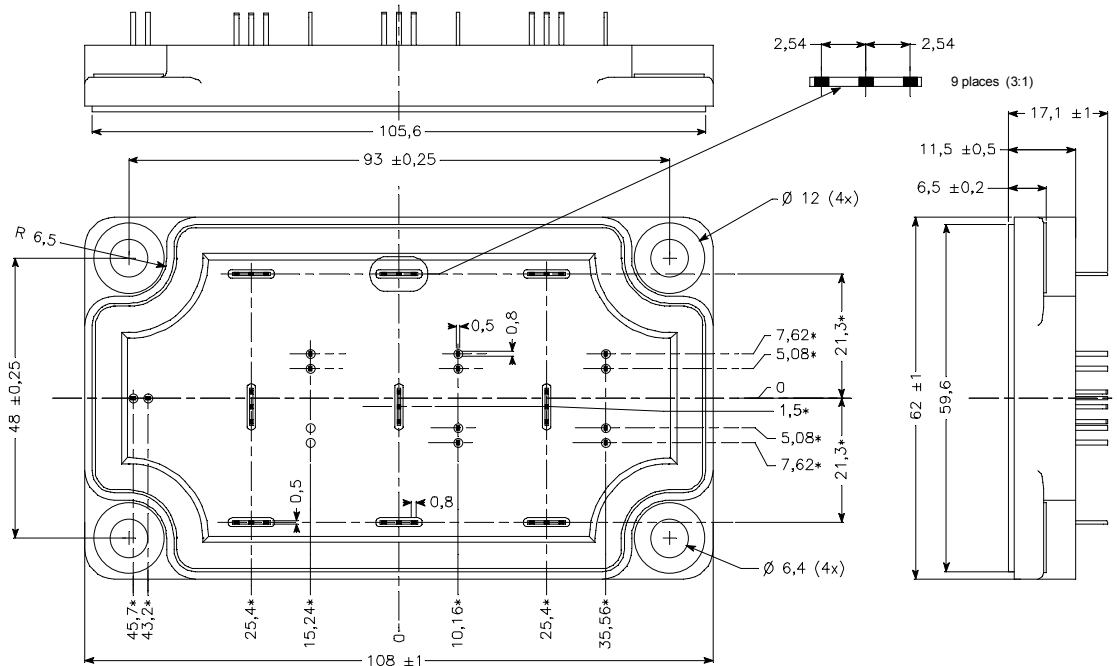

ALL DIMENSIONS MARKED "*" ARE TOLERANCED AS: $\pm 0,1$

See application note 1902 - Mounting Instructions for SP6-P (12mm) Power Modules on www.microsemi.com

7. Full bridge top switches curves

7.1 Top Trench + Field Stop IGBT typical performance curves

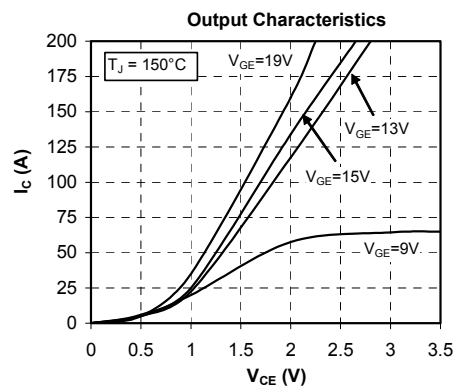
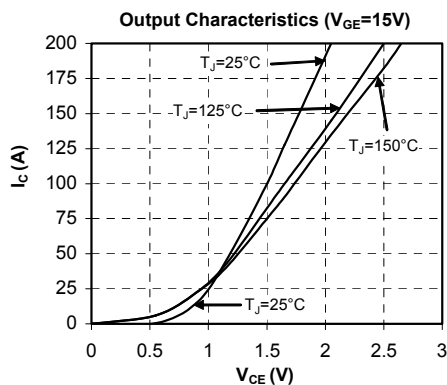

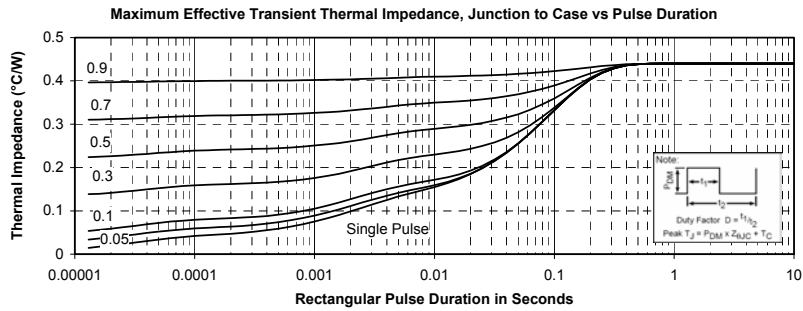
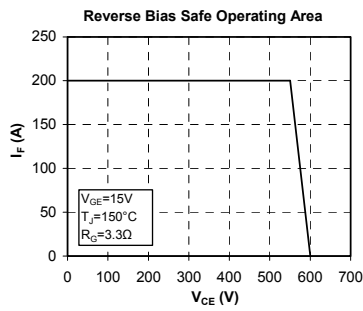
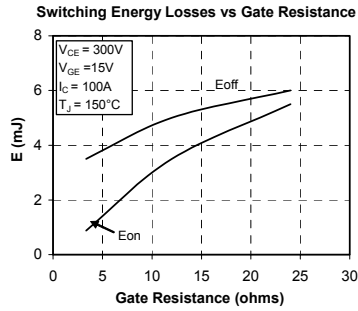
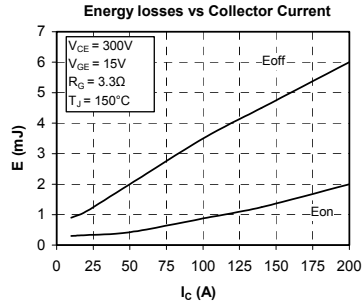
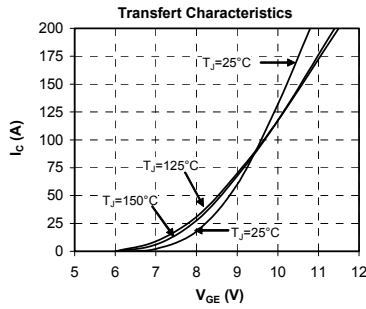

7.2 Top Fast diode typical performance curves

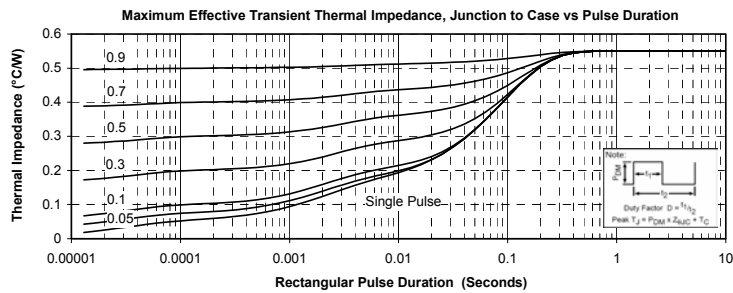
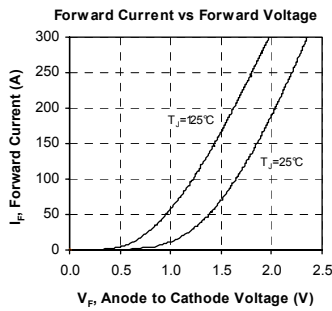

8. Full bridge bottom switches curves

8.1 Bottom fast NPT IGBT typical performance curves

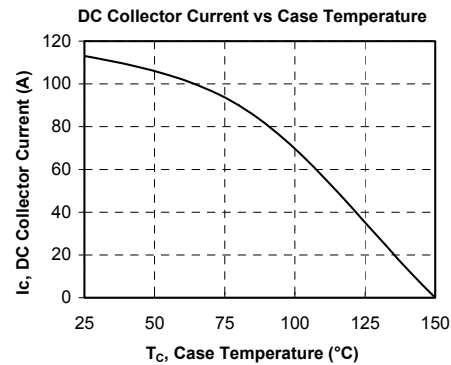
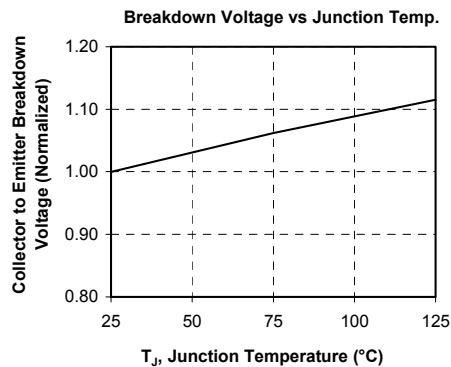
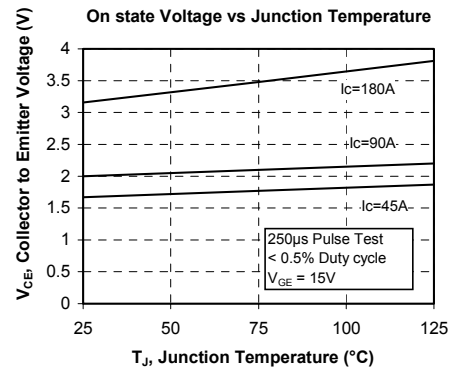
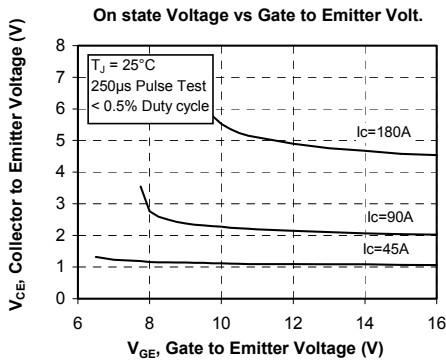
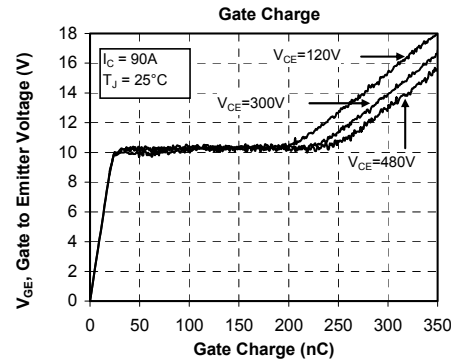
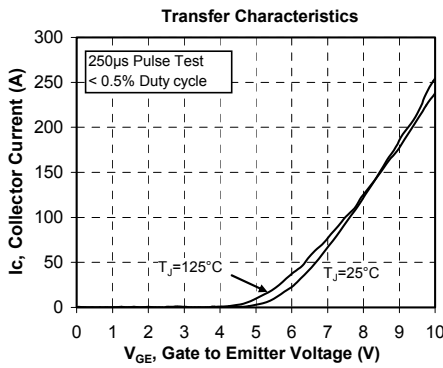
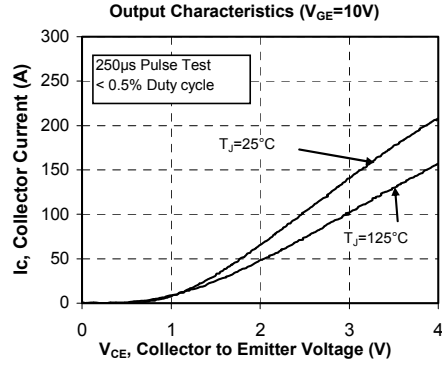
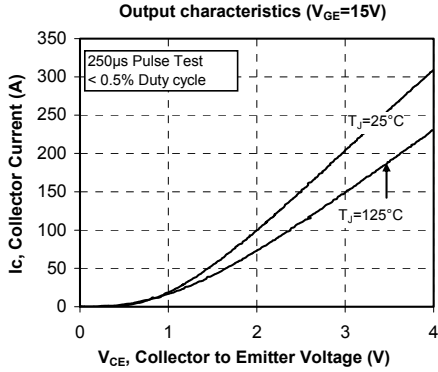

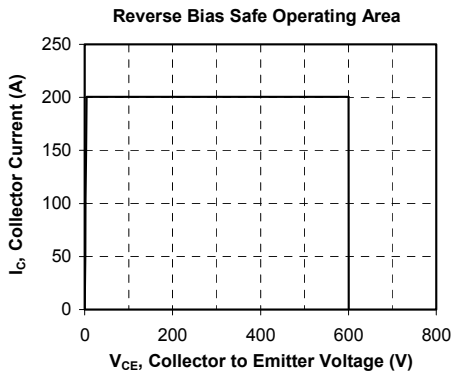
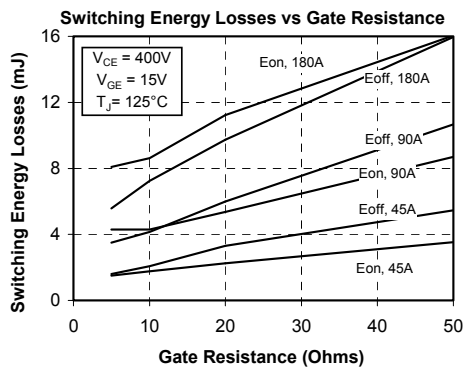
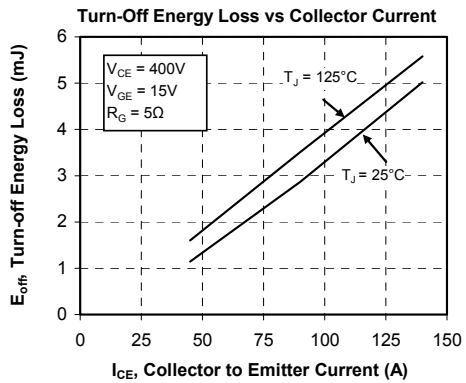
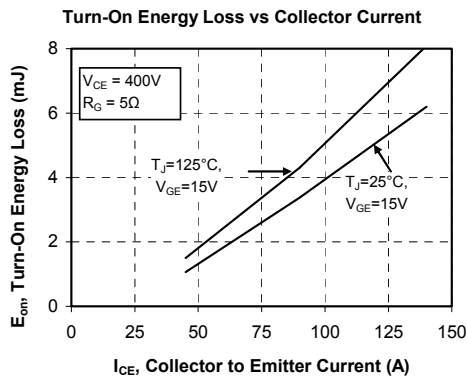
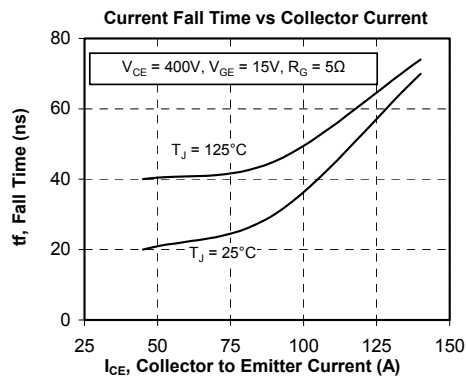
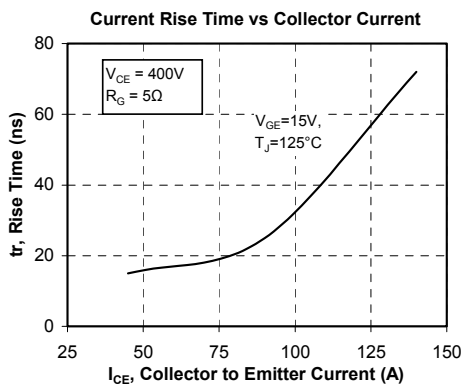
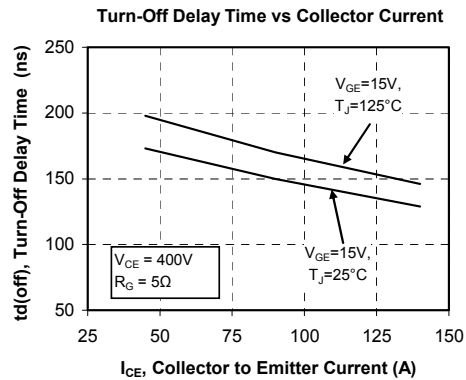
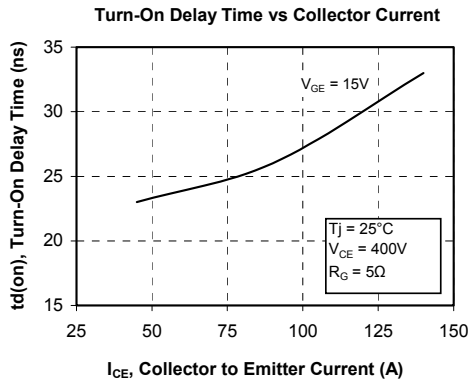

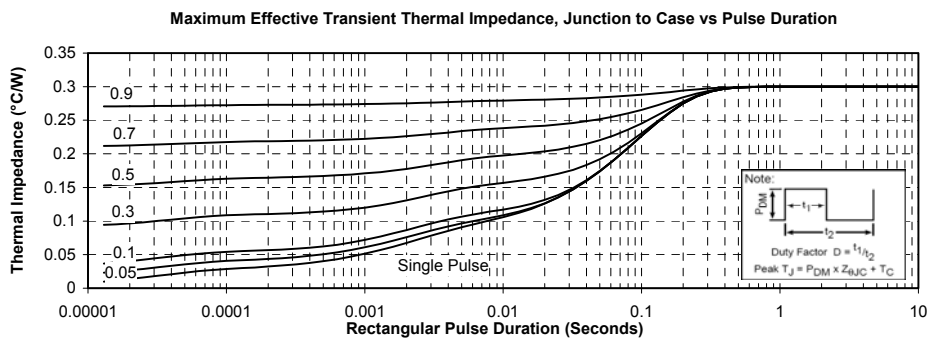
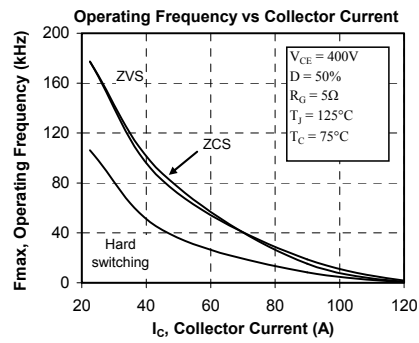
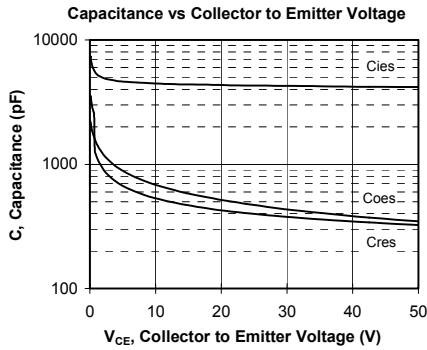

8.2 Bottom diode typical performance curves

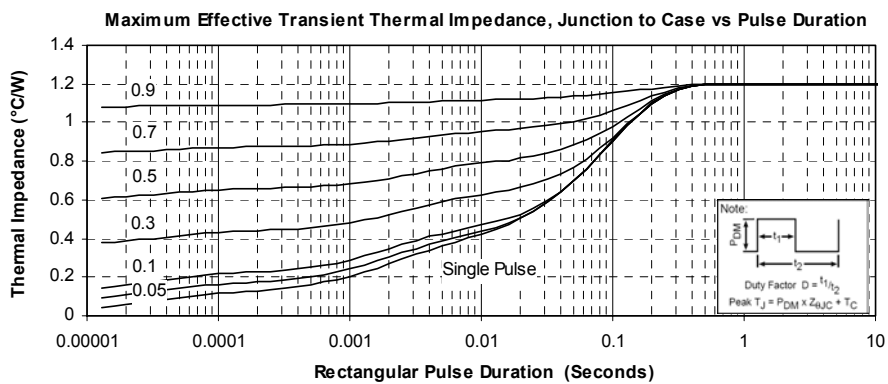
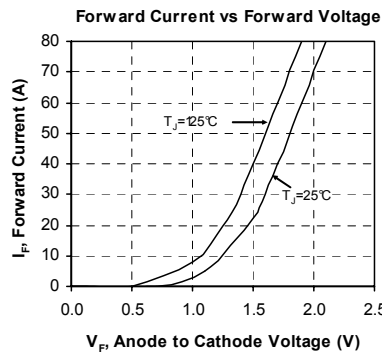

9. Boost chopper switch curves

9.1 CoolMOS™ typical performance curves

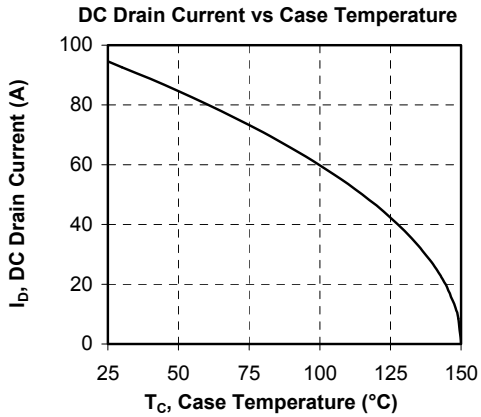
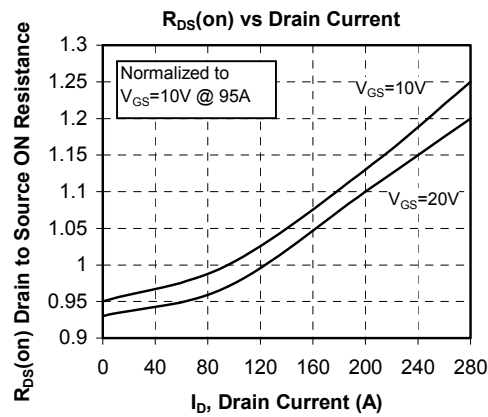
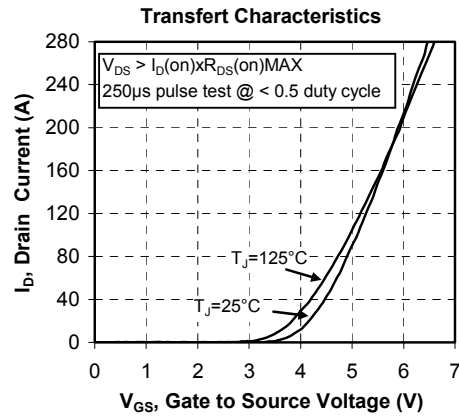
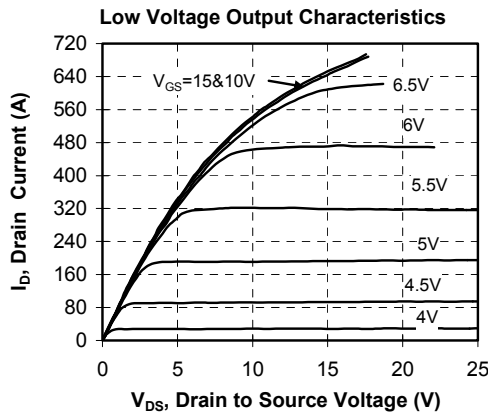
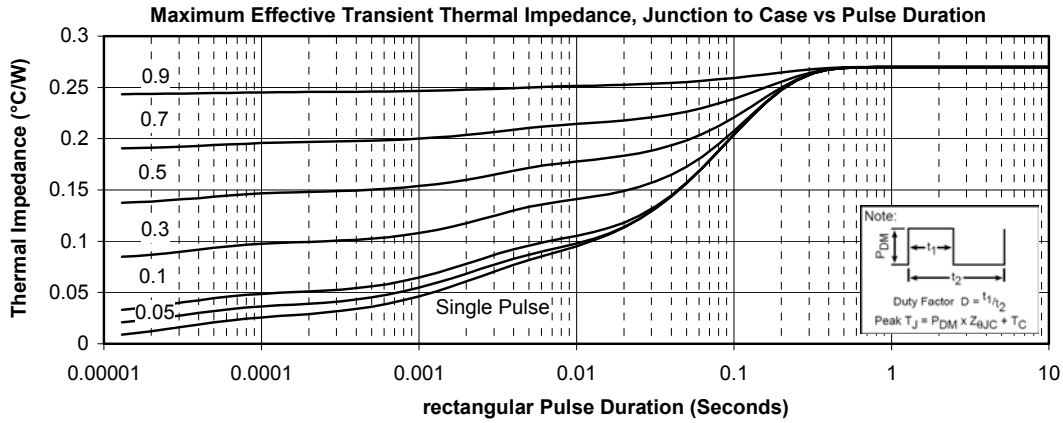

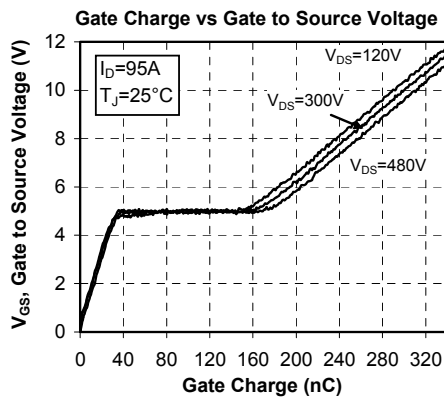
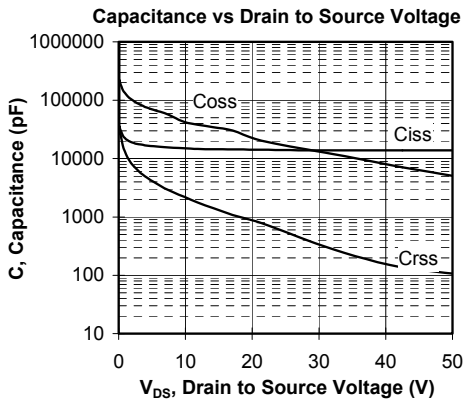
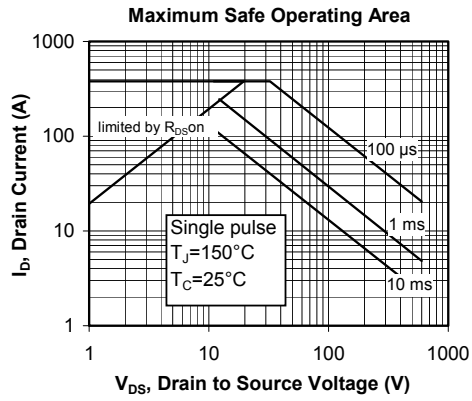
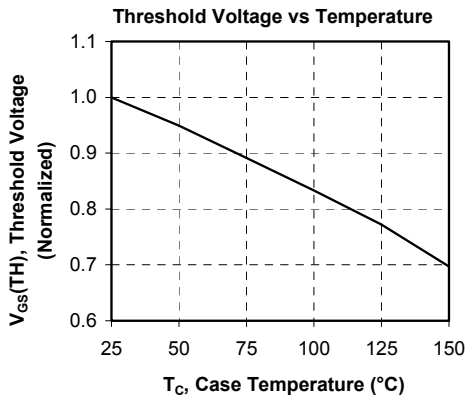
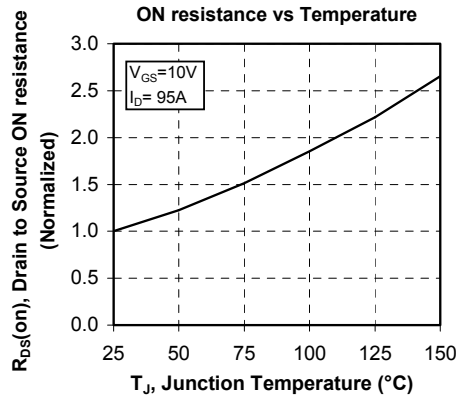
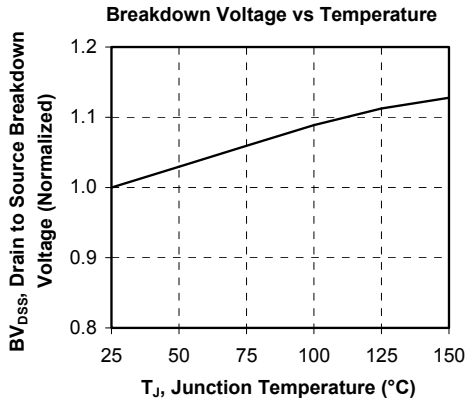

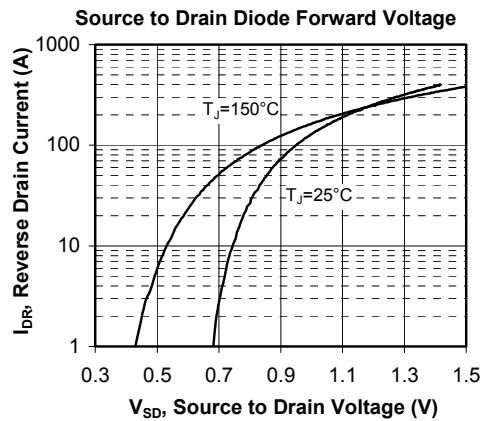
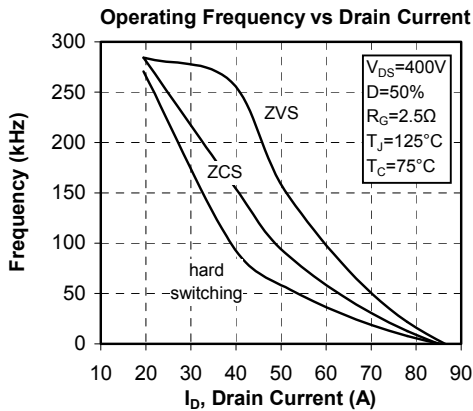
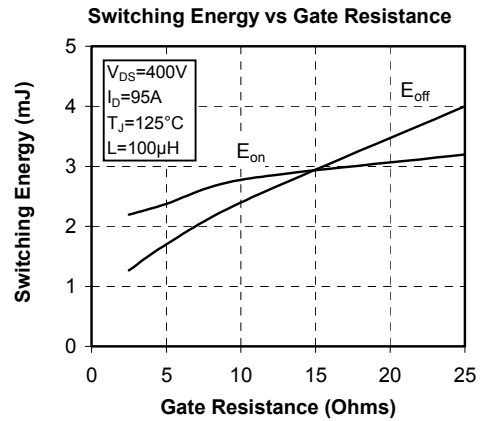
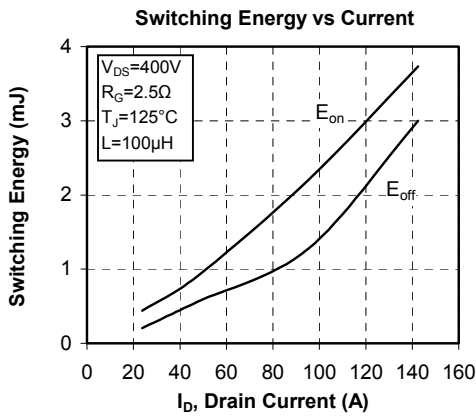
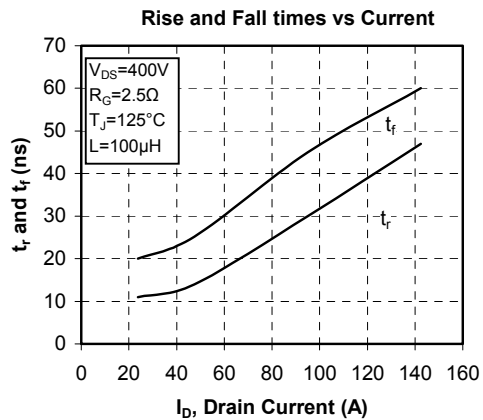
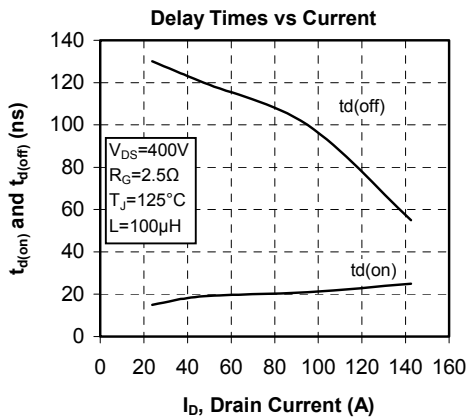

9.2 Chopper diode typical performance curves

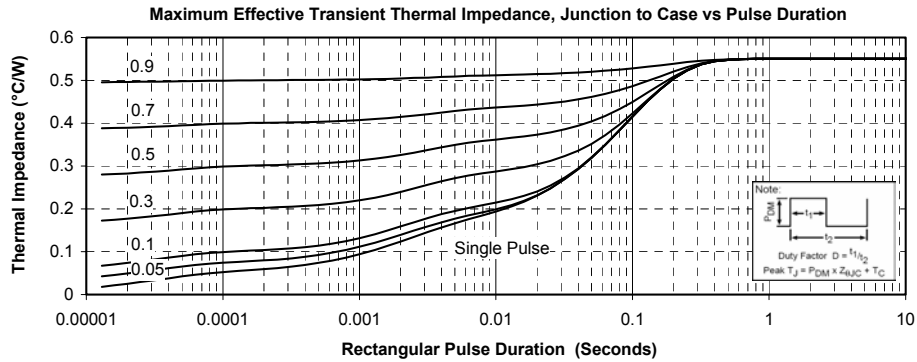
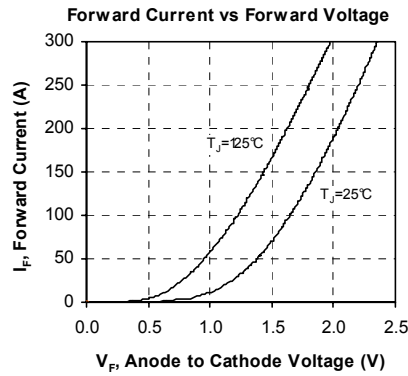

Microsemi reserves the right to change, without notice, the specifications and information contained herein

Microsemi's products are covered by one or more of U.S. patents 4,895,810 5,045,903 5,089,434 5,182,234 5,019,522 5,262,336 6,503,786 5,256,583 4,748,103 5,283,202 5,231,474 5,434,095 5,528,058 and foreign patents. U.S. and Foreign patents pending. All Rights Reserved.