

## Applications

- Military radar
- Civilian radar
- Land mobile and military radio communications
- Test instrumentation
- Wideband or narrowband amplifiers
- Jammers

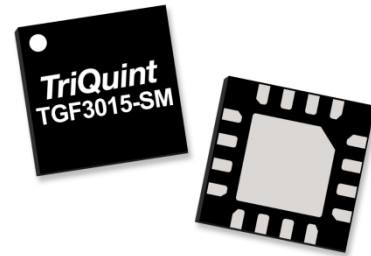

## Product Features

- Frequency: 30 MHz to 3.0 GHz
- Output Power ( $P_{3dB}$ ): 11 W at 2.4 GHz
- Linear Gain: 17.1 dB at 2.4 GHz
- Typical  $PAE_{3dB}$ : 62.7% at 2.4 GHz
- Operating Voltage: 32 V
- Low thermal resistance package
- CW and Pulse capable
- 3 x 3 mm package

## Functional Block Diagram

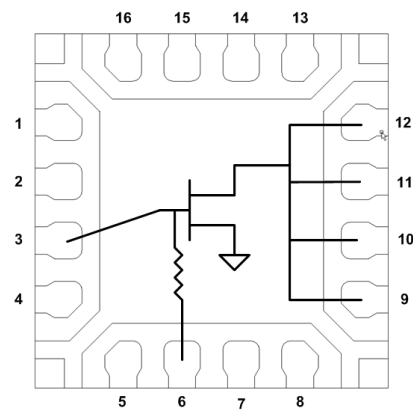

## General Description

The TriQuint TGF3015-SM is a 10W ( $P_{3dB}$ ), 50 $\Omega$ -input matched discrete GaN on SiC HEMT which operates from 30MHz to 3.0 GHz. The integrated input matching network enables wideband gain and power performance, while the output can be matched on board to optimize power and efficiency for any region within the band.

The device is housed in an industry-standard 3 x 3 mm package that saves real estate of already space-constrained handheld radios.

Lead-free and ROHS compliant

Evaluation boards are available upon request.

## Pin Configuration

Pin No.	Label
9 - 12	$V_D$ / RF OUT
3	$V_G$ / RF IN
6	Off-chip Shunt Cap for Low-Frequency Gain
Back side	Source

## Ordering Information

Part	ECCN	Description
TGF3015-SM	EAR99	QFN Packaged Part
TGF3015-SM-EVB1	EAR99	0.5 – 3 GHz EVB

## Absolute Maximum Ratings

Parameter	Value
Breakdown Voltage ( $V_{DG}$ )	100 V min.
Gate Voltage Range ( $V_G$ )	-50 to 0 V
Drain Current ( $I_D$ )	1.5 A
Gate Current ( $I_G$ )	-2.5 to 4.2 mA
Power Dissipation ( $P_D$ )	15 W
RF Input Power, CW, $T = 25^\circ\text{C}$ ( $P_{IN}$ )	27.5 dBm
Channel Temperature ( $T_{CH}$ )	275 °C
Mounting Temperature (30 Seconds)	320 °C
Storage Temperature	-40 to 150 °C

Operation of this device outside the parameter ranges given above may cause permanent damage. These are stress ratings only, and functional operation of the device at these conditions is not implied.

## Recommended Operating Conditions

Parameter <sup>1</sup>	Value
Drain Voltage ( $V_D$ )	32 V (Typ.)
Drain Quiescent Current ( $I_{DQ}$ )	50 mA (Typ.)
Peak Drain Current ( $I_D$ )	557 mA (Typ.)
Gate Voltage ( $V_G$ )	-2.7 V (Typ.)
Channel Temperature ( $T_{CH}$ )	225 °C (Max)
Power Dissipation, CW ( $P_D$ )	9.9 W (Max)
Power Dissipation, Pulse ( $P_D$ ) <sup>2</sup>	15.3 W (Max)

<sup>1</sup> Electrical specifications are measured at specified test conditions. Specifications are not guaranteed over all recommended operating conditions.

<sup>2</sup> 100uS Pulse Width, 20% Duty Cycle

## RF Characterization – Load Pull Performance at 1.0 GHz

Test conditions unless otherwise noted:  $T_A = 25^\circ\text{C}$ ,  $V_D = 32\text{ V}$ ,  $I_{DQ} = 50\text{ mA}$ , Pulse: 100uS Pulse Width, 20% Duty Cycle

Symbol	Parameter	Min	Typical	Max	Units
$G_{LIN}$	Linear Gain, Power Tuned		16.2		dB
$P_{3dB}$	Output Power at 3 dB Gain Compression, Power Tuned		40.2		dBm
$PAE_{3dB}$	Power-Added Efficiency at 3 dB Gain Compression, Efficiency Tuned		70.9		%
$G_{3dB}$	Gain at 3 dB Compression, Power Tuned		13.2		dB

## RF Characterization – Load Pull Performance at 2.0 GHz

Test conditions unless otherwise noted:  $T_A = 25^\circ\text{C}$ ,  $V_D = 32\text{ V}$ ,  $I_{DQ} = 50\text{ mA}$ , Pulse: 100uS Pulse Width, 20% Duty Cycle

Symbol	Parameter	Min	Typical	Max	Units
$G_{LIN}$	Linear Gain, Power Tuned		16.5		dB
$P_{3dB}$	Output Power at 3 dB Gain Compression, Power Tuned		40.6		dBm
$PAE_{3dB}$	Power-Added Efficiency at 3 dB Gain Compression, Efficiency Tuned		61.7		%
$G_{3dB}$	Gain at 3 dB Compression, Power Tuned		13.5		dB

## RF Characterization – Load Pull Performance at 2.4 GHz

Test conditions unless otherwise noted:  $T_A = 25\text{ }^\circ\text{C}$ ,  $V_D = 32\text{ V}$ ,  $I_{DQ} = 50\text{ mA}$ , Pulse: 100uS Pulse Width, 20% Duty Cycle

Symbol	Parameter	Min	Typical	Max	Units
$G_{LIN}$	Linear Gain, Power Tuned		17.1		dB
$P_{3dB}$	Output Power at 3 dB Gain Compression, Power Tuned		40.4		dBm
$PAE_{3dB}$	Power-Added Efficiency at 3 dB Gain Compression, Efficiency Tuned		62.7		%
$G_{3dB}$	Gain at 3 dB Compression, Power Tuned		14.1		dB

## RF Characterization – Load Pull Performance at 2.7 GHz

Test conditions unless otherwise noted:  $T_A = 25\text{ }^\circ\text{C}$ ,  $V_D = 32\text{ V}$ ,  $I_{DQ} = 50\text{ mA}$ , Pulse: 100uS Pulse Width, 20% Duty Cycle

Symbol	Parameter	Min	Typical	Max	Units
$G_{LIN}$	Linear Gain, Power Tuned		16.3		dB
$P_{3dB}$	Output Power at 3 dB Gain Compression, Power Tuned		40.5		dBm
$PAE_{3dB}$	Power-Added Efficiency at 3 dB Gain Compression, Efficiency Tuned		63.7		%
$G_{3dB}$	Gain at 3 dB Compression, Power Tuned		13.3		dB

## RF Characterization – Load Pull Performance at 3.0 GHz

Test conditions unless otherwise noted:  $T_A = 25\text{ }^\circ\text{C}$ ,  $V_D = 32\text{ V}$ ,  $I_{DQ} = 50\text{ mA}$ , Pulse: 100uS Pulse Width, 20% Duty Cycle

Symbol	Parameter	Min	Typical	Max	Units
$G_{LIN}$	Linear Gain, Power Tuned		15.4		dB
$P_{3dB}$	Output Power at 3 dB Gain Compression, Power Tuned		40.5		dBm
$PAE_{3dB}$	Power-Added Efficiency at 3 dB Gain Compression, Efficiency Tuned		58.6		%
$G_{3dB}$	Gain at 3 dB Compression, Power Tuned		12.4		dB

### RF Characterization – EVB Performance at 2.4 GHz

Test conditions unless otherwise noted:  $T_A = 25\text{ }^\circ\text{C}$ ,  $V_D = 32\text{ V}$ ,  $I_{DQ} = 50\text{ mA}$ , Pulse: 100uS Pulse Width, 20% Duty Cycle

Symbol	Parameter	Min	Typical	Max	Units
$G_{LIN}$	Linear Gain		17.0		dB
$P_{3dB}$	Output Power at 3 dB Gain Compression		9.3		W
$DE_{3dB}$	Drain Efficiency at 3 dB Gain Compression		50.7		%
$G_{3dB}$	Gain at 3 dB Compression		14.0		dB

### RF Characterization – Mismatch Ruggedness at 3.0 GHz

Test conditions unless otherwise noted:  $T_A = 25\text{ }^\circ\text{C}$ ,  $V_D = 32\text{ V}$ ,  $I_{DQ} = 50\text{ mA}$

Driving input power is determined at 3dB Pulsed compression under matched condition at EVB output connector.

Symbol	Parameter	Typical
VSWR	Impedance Mismatch Ruggedness	10:1

## Thermal and Reliability Information - CW <sup>1</sup>

Parameter	Test Conditions	Value	Units
Thermal Resistance ( $\theta_{JC}$ )	Vds = 32V, Idq = 50mA	11.6	$^{\circ}\text{C}/\text{W}$
Channel Temperature ( $T_{CH}$ )	85 $^{\circ}\text{C}$ Case	114	$^{\circ}\text{C}$
Median Lifetime ( $T_M$ )	2.5 W Pdiss, CW	2.15E11	Hrs
Thermal Resistance ( $\theta_{JC}$ )	Vds = 32V, Idq = 50mA	12.2	$^{\circ}\text{C}/\text{W}$
Channel Temperature ( $T_{CH}$ )	85 $^{\circ}\text{C}$ Case	146	$^{\circ}\text{C}$
Median Lifetime ( $T_M$ )	5 W Pdiss, CW	3.89E9	Hrs
Thermal Resistance ( $\theta_{JC}$ )	Vds = 32V, Idq = 50mA	13.1	$^{\circ}\text{C}/\text{W}$
Channel Temperature ( $T_{CH}$ )	85 $^{\circ}\text{C}$ Case	183	$^{\circ}\text{C}$
Median Lifetime ( $T_M$ )	7.5 W Pdiss, CW	7.82E7	Hrs
Thermal Resistance ( $\theta_{JC}$ )	Vds = 32V, Idq = 50mA	14.2	$^{\circ}\text{C}/\text{W}$
Channel Temperature ( $T_{CH}$ )	85 $^{\circ}\text{C}$ Case	227	$^{\circ}\text{C}$
Median Lifetime ( $T_M$ )	10 W Pdiss, CW	1.54E6	Hrs
Thermal Resistance ( $\theta_{JC}$ )	Vds = 32V, Idq = 50mA	15.5	$^{\circ}\text{C}/\text{W}$
Channel Temperature ( $T_{CH}$ )	85 $^{\circ}\text{C}$ Case	279	$^{\circ}\text{C}$
Median Lifetime ( $T_M$ )	12.5 W Pdiss, CW	3.35E4	Hrs

Notes:

1. Thermal resistance measured to bottom of package.

## Thermal and Reliability Information - Pulsed <sup>1</sup>

Parameter	Test Conditions	Value	Units
Thermal Resistance ( $\theta_{JC}$ )	Vds = 32V, Idq = 50mA	8.4	$^{\circ}\text{C}/\text{W}$
Channel Temperature ( $T_{CH}$ )	85 $^{\circ}\text{C}$ Case	169	$^{\circ}\text{C}$
Median Lifetime ( $T_M$ )	10 W Pdiss, 100uS PW, 20%	3.18E8	Hrs
Thermal Resistance ( $\theta_{JC}$ )	Vds = 32V, Idq = 50mA	8.7	$^{\circ}\text{C}/\text{W}$
Channel Temperature ( $T_{CH}$ )	85 $^{\circ}\text{C}$ Case	194	$^{\circ}\text{C}$
Median Lifetime ( $T_M$ )	12.5 W Pdiss, 100uS PW, 20%	2.73E7	Hrs
Thermal Resistance ( $\theta_{JC}$ )	Vds = 32V, Idq = 50mA	9.1	$^{\circ}\text{C}/\text{W}$
Channel Temperature ( $T_{CH}$ )	85 $^{\circ}\text{C}$ Case	221	$^{\circ}\text{C}$
Median Lifetime ( $T_M$ )	15 W Pdiss, 100uS PW, 20%	2.54E6	Hrs

Notes:

1. Thermal resistance measured to bottom of package.

**Median Lifetime**

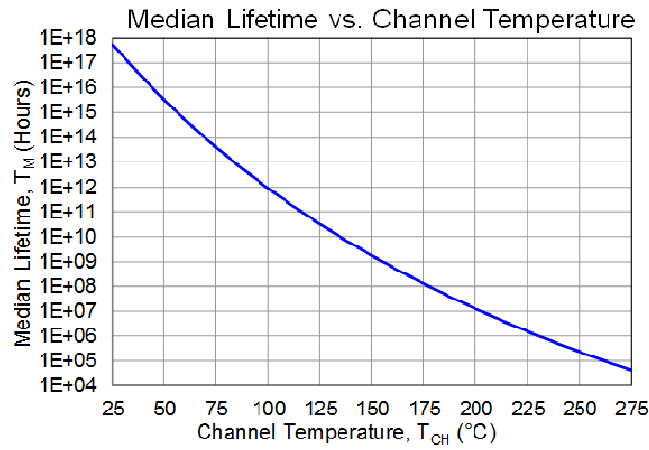

**Maximum Channel Temperature**

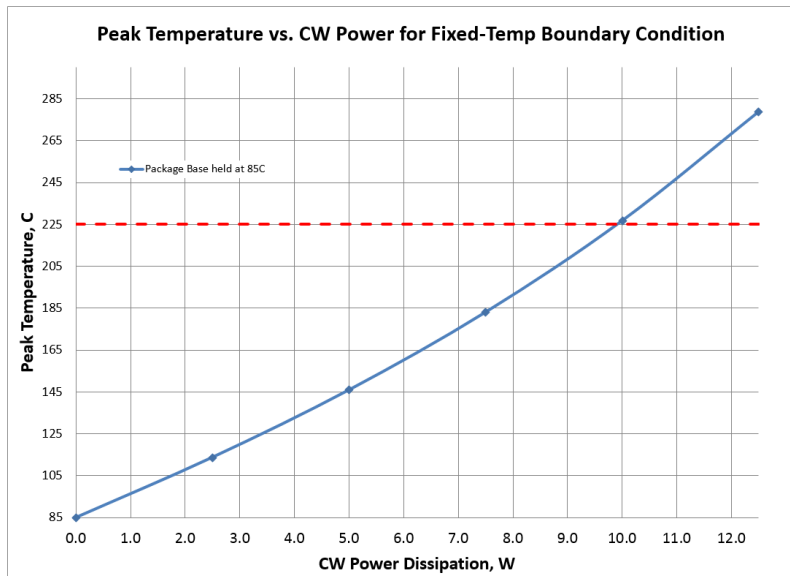

**Load Pull Smith Charts <sup>(1, 2)</sup>**

RF performance that the device typically exhibits when placed in the specified impedance environment. The impedances are not the impedances of the device, they are the impedances presented to the device via an RF circuit or load-pull system. The impedances listed follow an optimized trajectory to maintain high power and high efficiency.

Notes:

1. 32V, 50mA, Pulsed signal with 100uS pulse width and 20% duty cycle. 3dB compression referenced at peak gain.
2. See page 18 for load pull and source pull reference planes.



**1GHz, Load-pull**

$Z_s(f_0) = 50.18 - 2.82i\Omega$   
 $Z_s(2f_0) = 38.17 - 12.93i\Omega$   
 $Z_s(3f_0) = 33.86 + 8.44i\Omega$   
 $Z_l(2f_0) = 26.76 - 50.31i\Omega$   
 $Z_l(3f_0) = 26.14 - 39.51i\Omega$

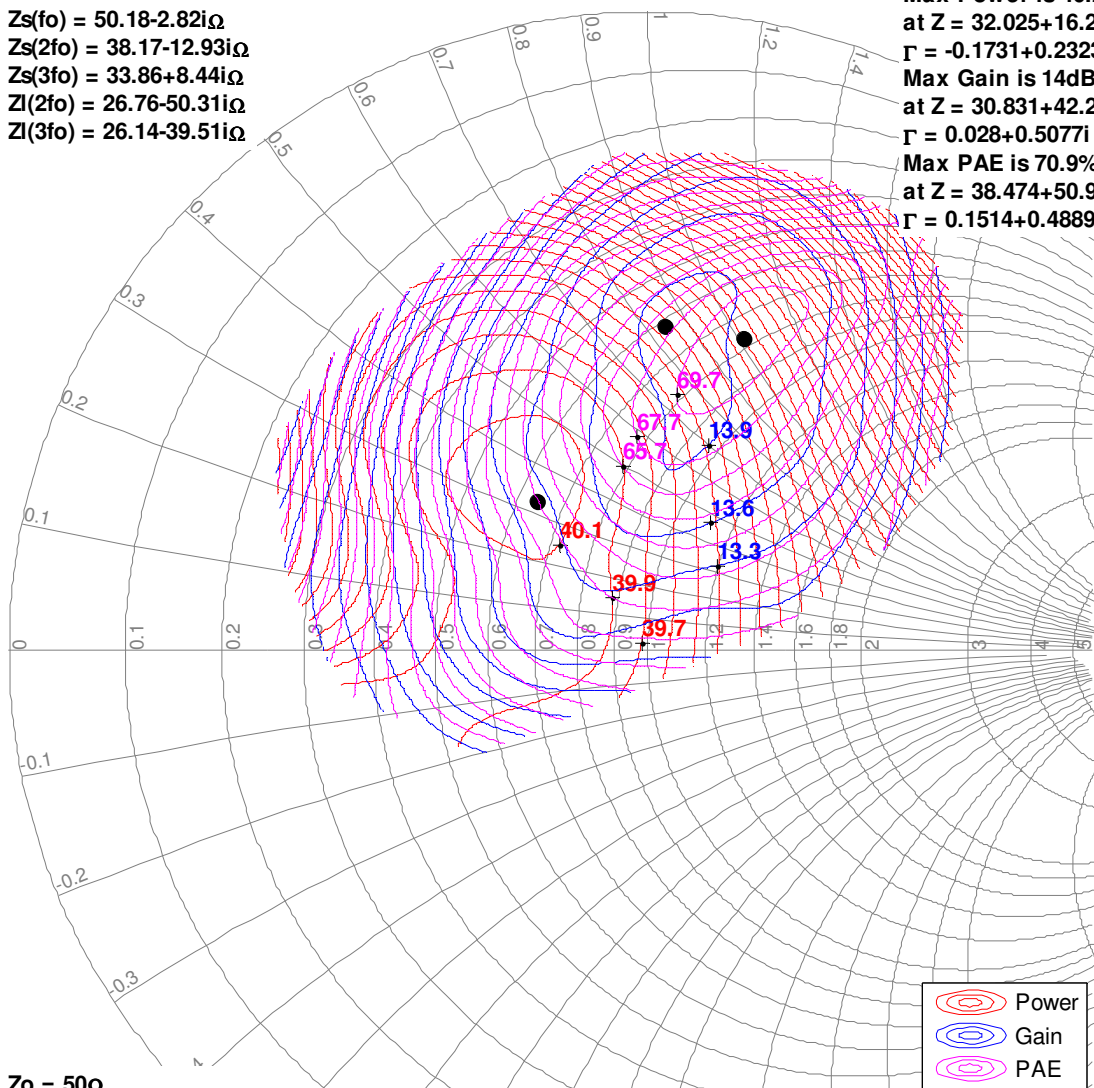
Max Power is 40.2dBm  
 at  $Z = 32.025 + 16.241i\Omega$   
 $\Gamma = -0.1731 + 0.2323i$   
 Max Gain is 14dB  
 at  $Z = 30.831 + 42.221i\Omega$   
 $\Gamma = 0.028 + 0.5077i$   
 Max PAE is 70.9%  
 at  $Z = 38.474 + 50.971i\Omega$   
 $\Gamma = 0.1514 + 0.4889i$



$Z_0 = 50\Omega$   
 Peak-gain referenced

	Power
	Gain
	PAE

**Load Pull Smith Charts <sup>(1, 2)</sup>**

RF performance that the device typically exhibits when placed in the specified impedance environment. The impedances are not the impedances of the device, they are the impedances presented to the device via an RF circuit or load-pull system. The impedances listed follow an optimized trajectory to maintain high power and high efficiency.

Notes:

1. 32V, 50mA, Pulsed signal with 100uS pulse width and 20% duty cycle. 3dB compression referenced at peak gain.
2. See page 18 for load pull and source pull reference planes.

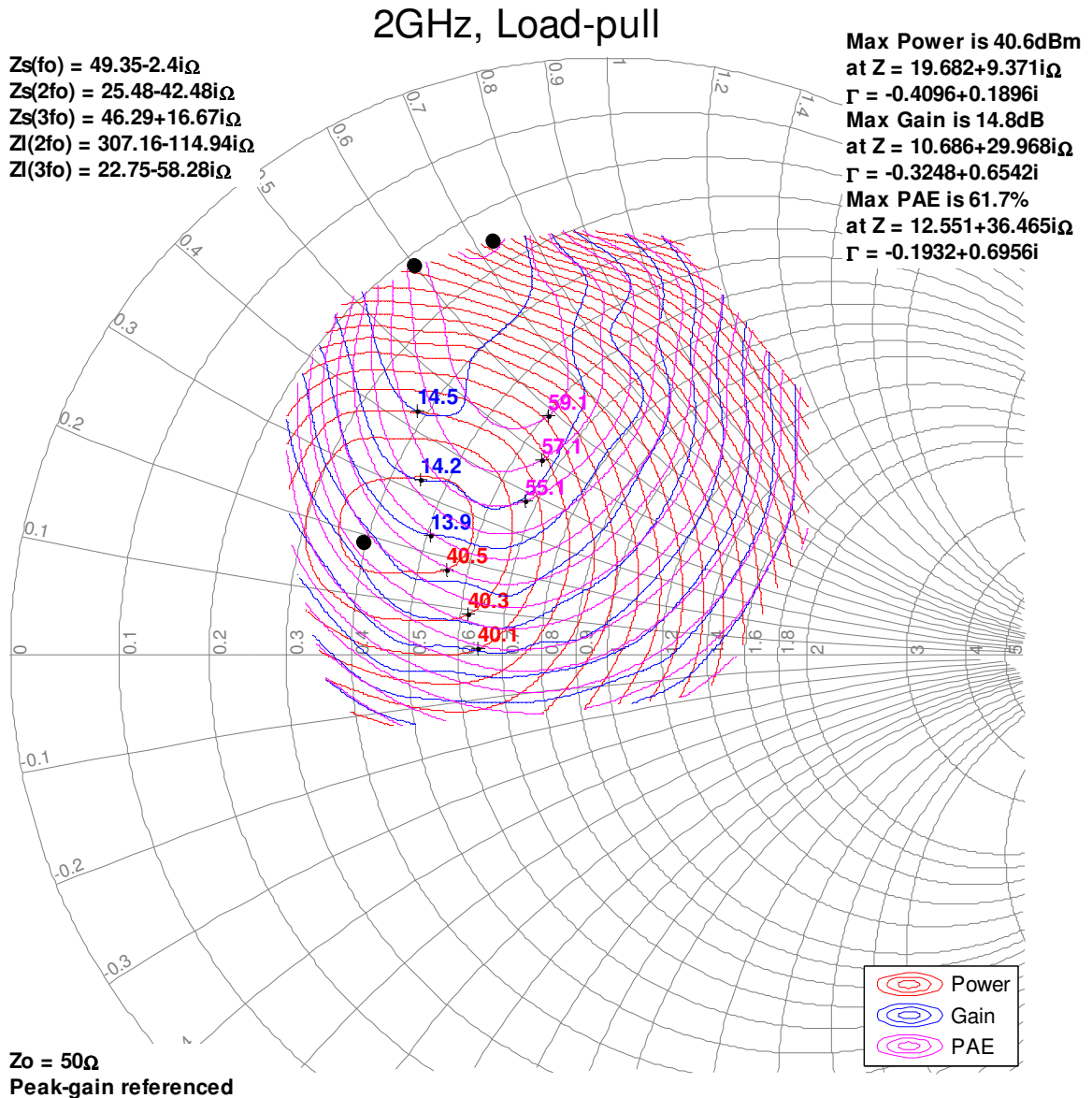



**Load Pull Smith Charts <sup>(1, 2)</sup>**

RF performance that the device typically exhibits when placed in the specified impedance environment. The impedances are not the impedances of the device, they are the impedances presented to the device via an RF circuit or load-pull system. The impedances listed follow an optimized trajectory to maintain high power and high efficiency.

Notes:

1. 32V, 50mA, Pulsed signal with 100uS pulse width and 20% duty cycle. 3dB compression referenced at peak gain.
2. See page 18 for load pull and source pull reference planes.

**2.4GHz, Load-pull**

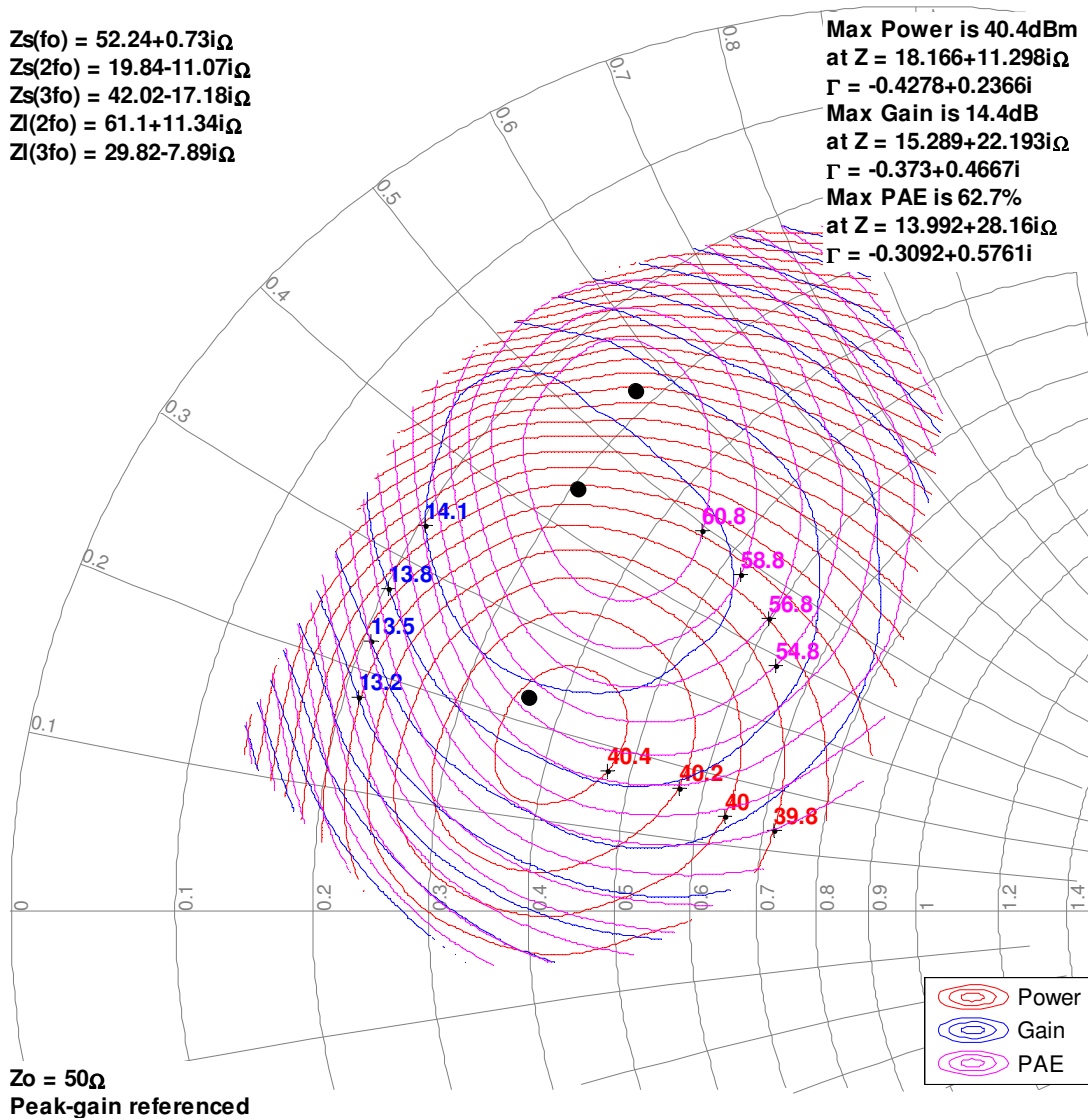

**Load Pull Smith Charts <sup>(1, 2)</sup>**

RF performance that the device typically exhibits when placed in the specified impedance environment. The impedances are not the impedances of the device, they are the impedances presented to the device via an RF circuit or load-pull system. The impedances listed follow an optimized trajectory to maintain high power and high efficiency.

Notes:

1. 32V, 50mA, Pulsed signal with 100uS pulse width and 20% duty cycle. 3dB compression referenced at peak gain.
2. See page 18 for load pull and source pull reference planes.

**2.7GHz, Load-pull**

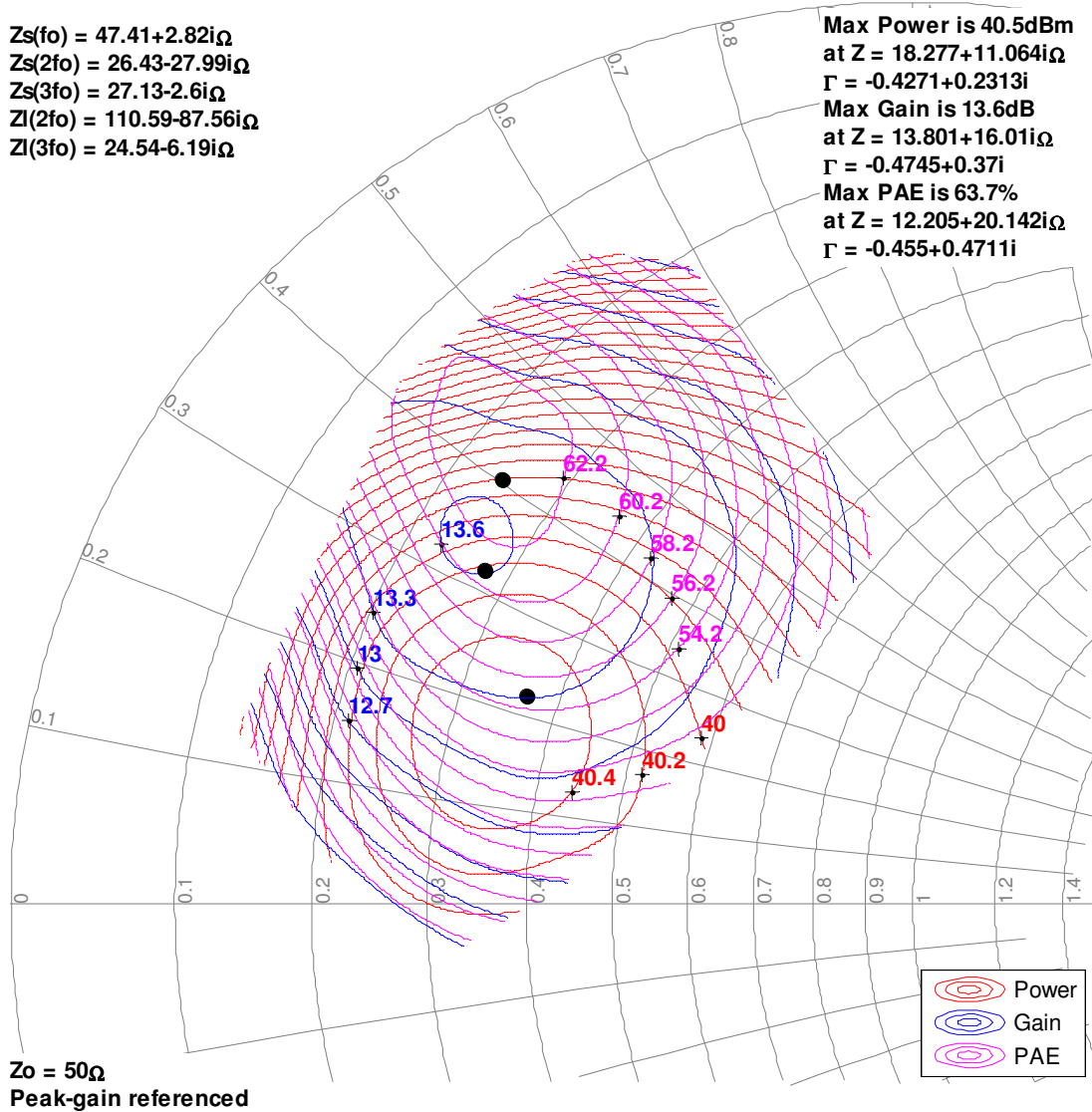

**Load Pull Smith Charts <sup>(1, 2)</sup>**

RF performance that the device typically exhibits when placed in the specified impedance environment. The impedances are not the impedances of the device, they are the impedances presented to the device via an RF circuit or load-pull system. The impedances listed follow an optimized trajectory to maintain high power and high efficiency.

Notes:

1. 32V, 50mA, Pulsed signal with 100uS pulse width and 20% duty cycle. 3dB compression referenced at peak gain.
2. See page 18 for load pull and source pull reference planes.

**3GHz, Load-pull**

$Z_s(f_0) = 49.59 - 1.28i\Omega$   
 $Z_s(2f_0) = 44 + 10.41i\Omega$   
 $Z_s(3f_0) = 25.67 - 8.3i\Omega$   
 $Z_l(2f_0) = 65.18 + 44.62i\Omega$   
 $Z_l(3f_0) = 38.87 - 26.64i\Omega$

**Max Power is 40.5dBm**  
 at  $Z = 18.327 + 11.73i\Omega$   
 $\Gamma = -0.4216 + 0.2441i$   
**Max Gain is 12.4dB**  
 at  $Z = 12.252 + 20.075i\Omega$   
 $\Gamma = -0.4551 + 0.4692i$   
**Max PAE is 58.6%**  
 at  $Z = 10.574 + 22.744i\Omega$   
 $\Gamma = -0.4469 + 0.5433i$

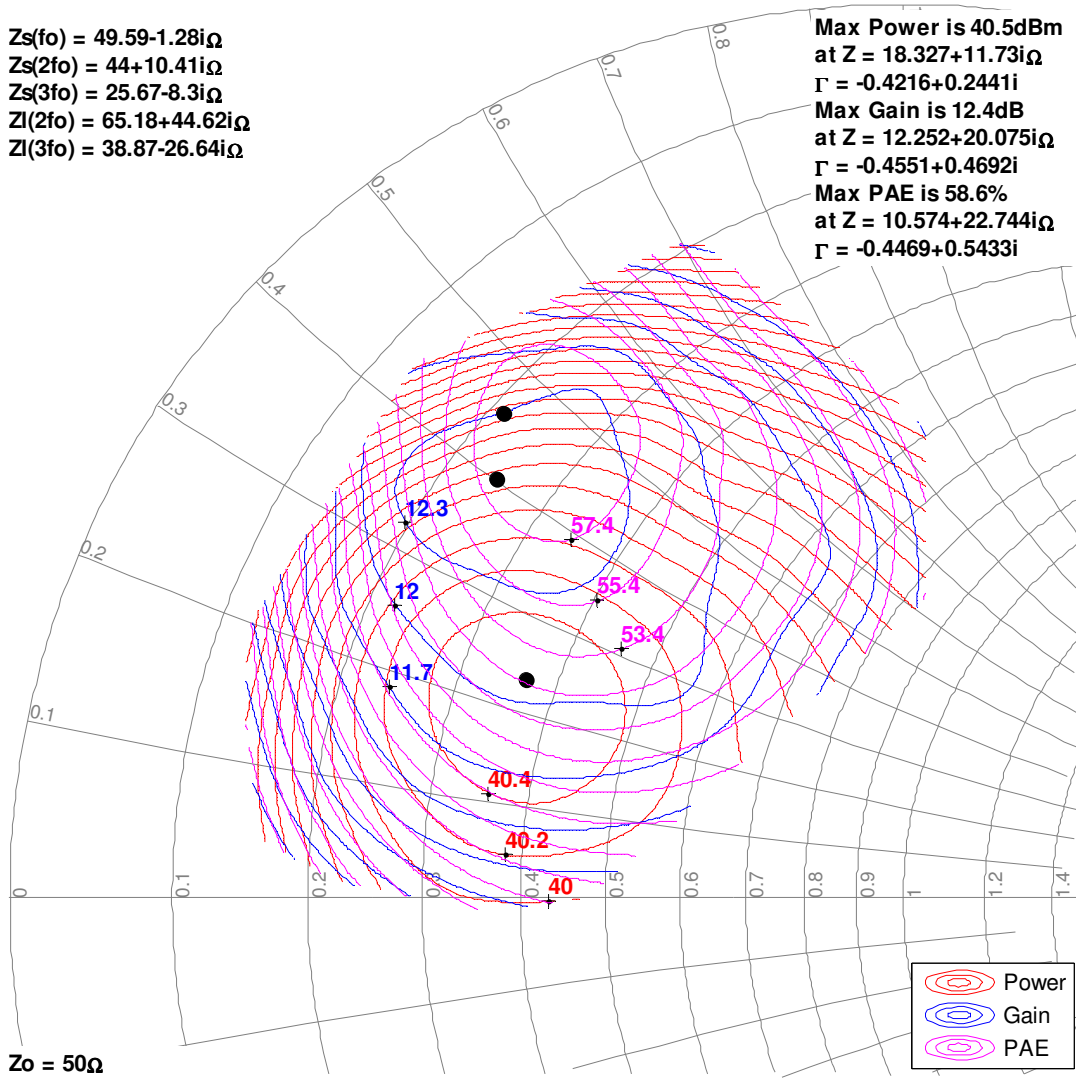

$Z_0 = 50\Omega$   
 Peak-gain referenced

	Power
	Gain
	PAE

**Typical Performance – Power Tuned<sup>(1,2,3)</sup>**

Notes:

1. Pulsed signal with 100uS pulse width and 20% duty cycle
2. See page 18 for load pull and source pull reference planes.
3. Performance is measured at device reference planes.

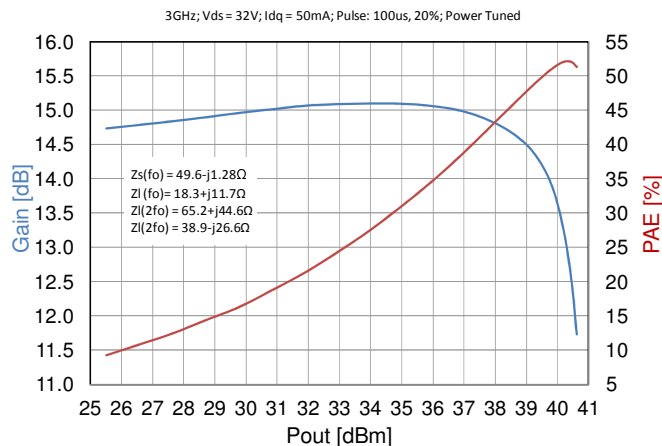
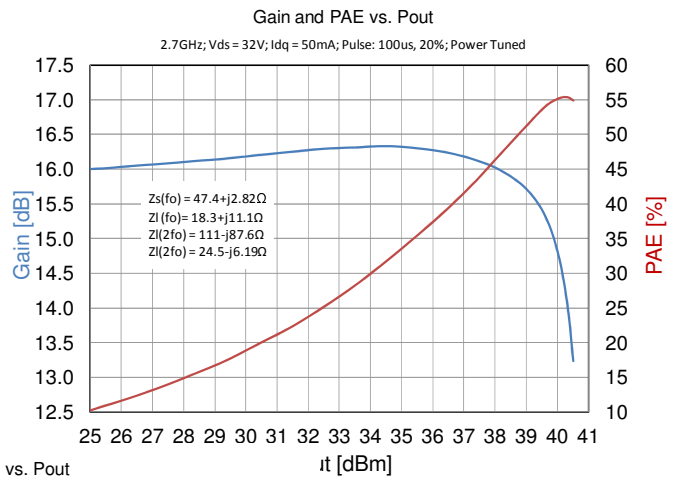
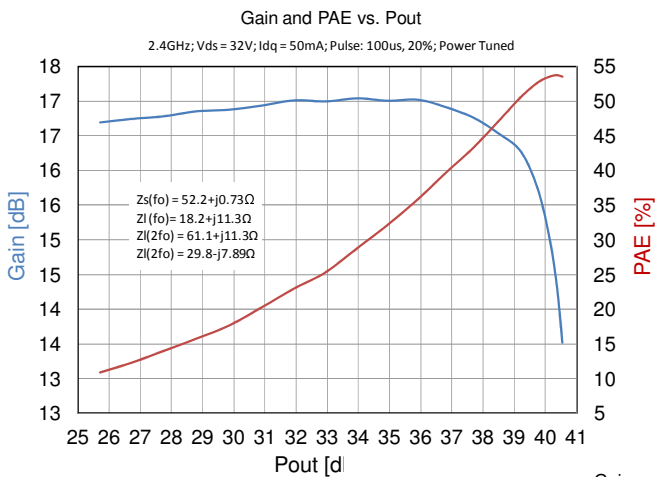
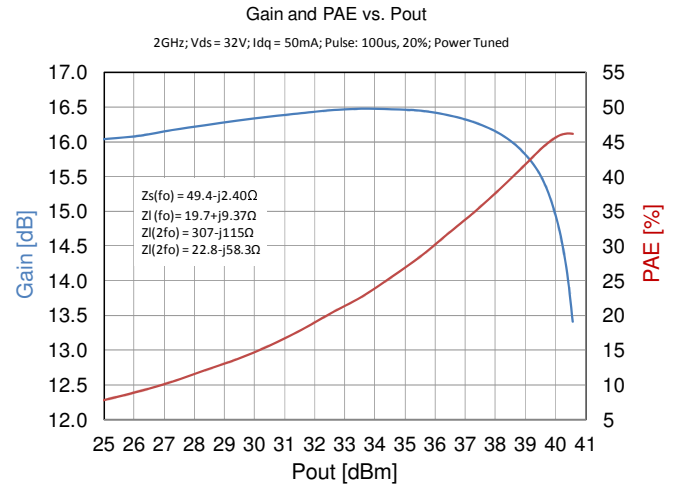
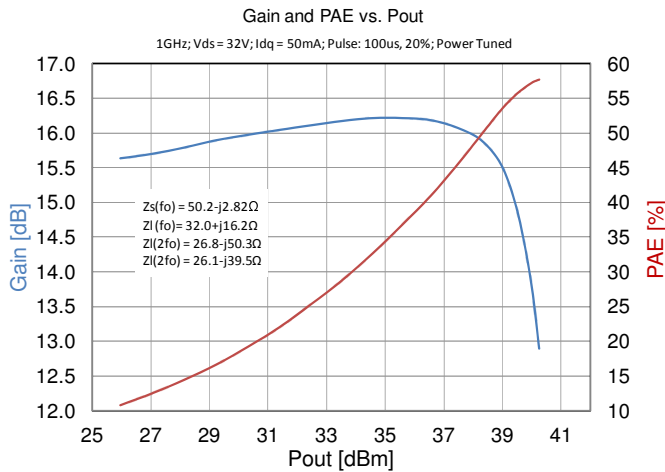

**Typical Performance – Efficiency Tuned<sup>(1,2,3)</sup>**

Notes:

1. Pulsed signal with 100µs pulse width and 20% duty cycle
2. See page 18 for load pull and source pull reference planes.

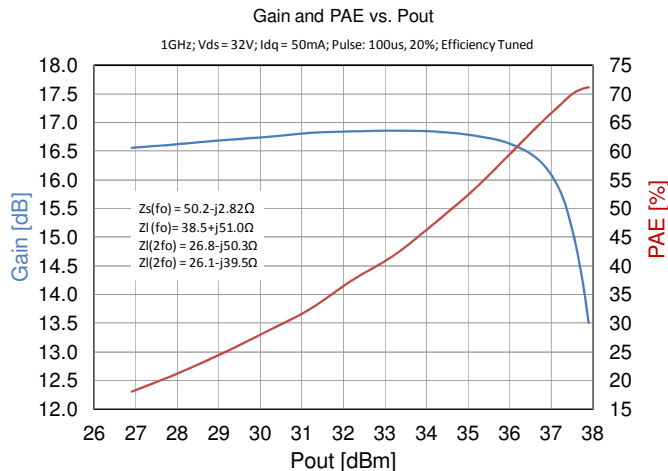
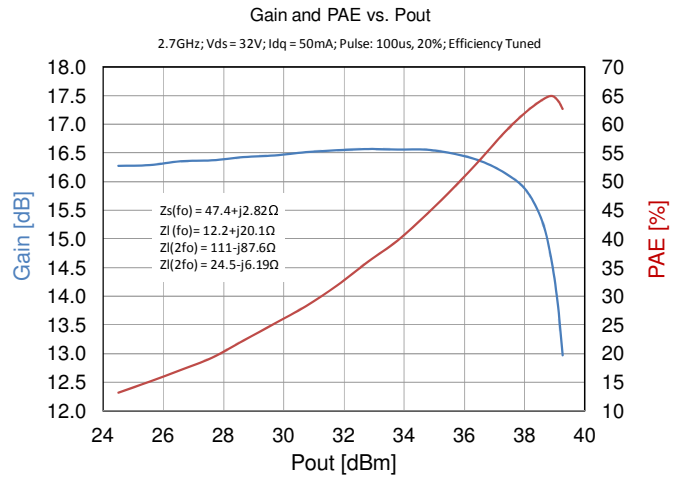
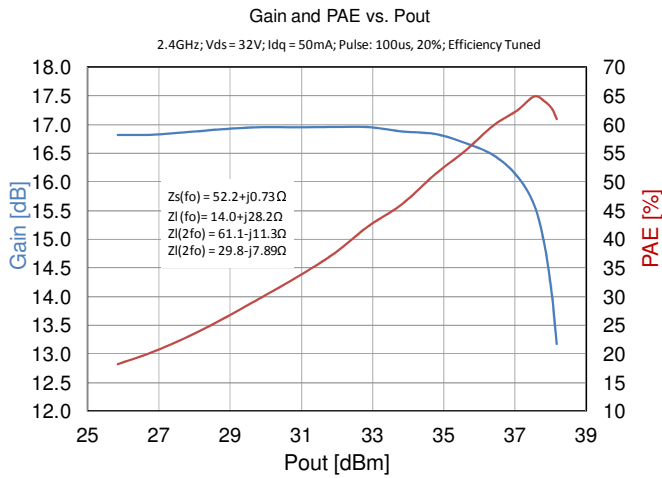
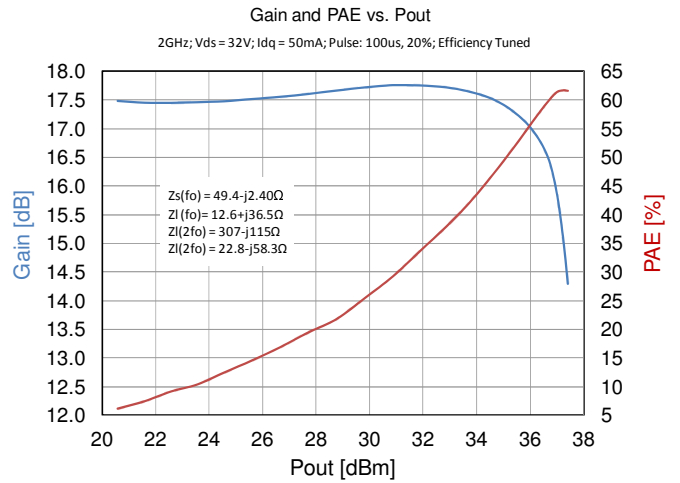
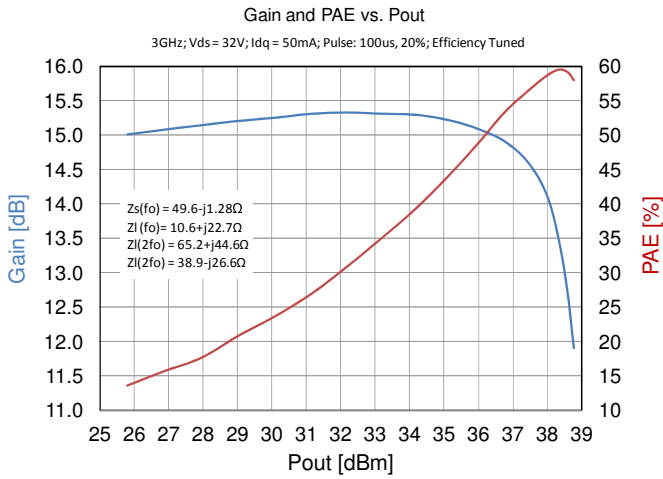

**Evaluation Board Performance Over Temperature (1, 2)**

Performance measured on TriQuint's 0.5 GHz to 3 GHz Evaluation Board

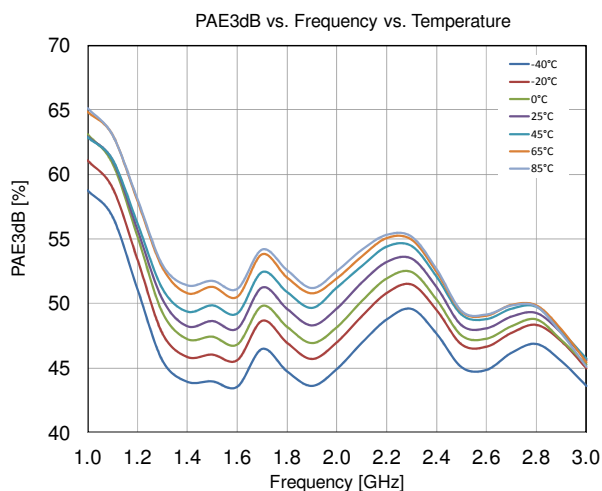
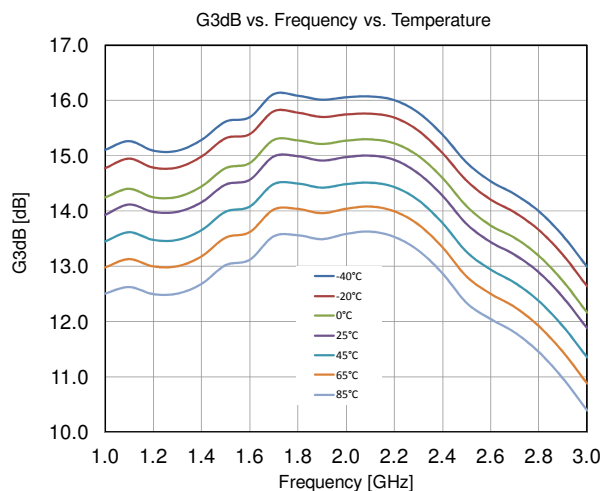
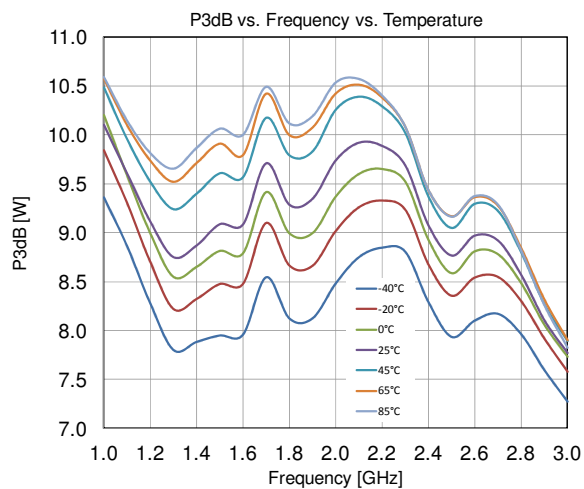

**Notes:**

1. Test Conditions:  $V_{DS} = 32\text{ V}$ ,  $I_{DQ} = 50\text{ mA}$
2. Test Signal: Pulse Width = 100  $\mu\text{s}$ , Duty Cycle = 20%

**Evaluation Board Performance At 25 °C<sup>(1, 2)</sup>**

Performance measured on TriQuint's 0.5 GHz to 3.0 GHz Evaluation Board

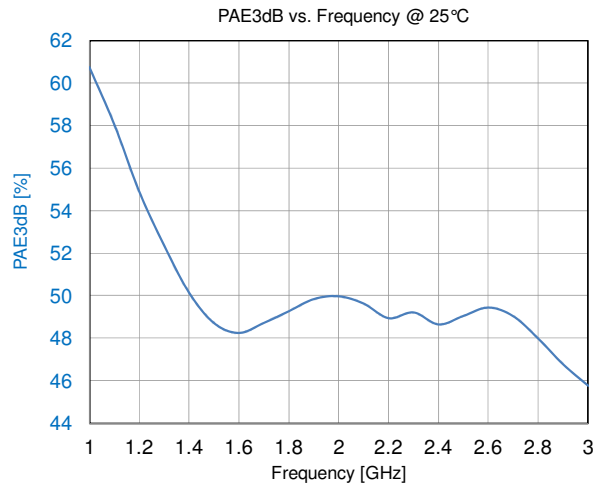
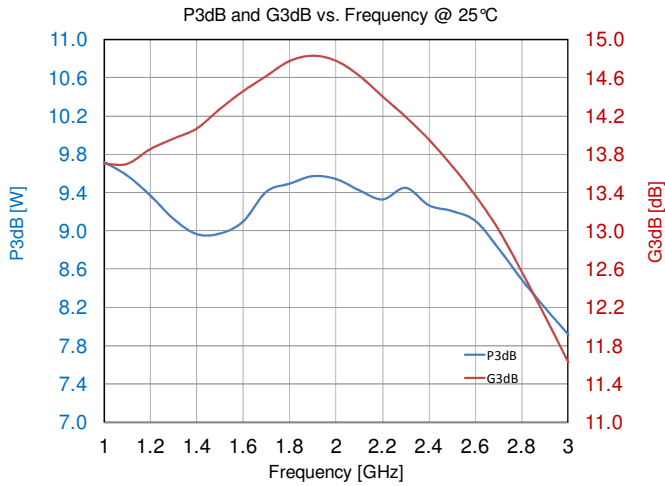

Notes:

1. Test Conditions:  $V_{DS} = 32\text{ V}$ ,  $I_{DQ} = 50\text{ mA}$ ,  $25\text{ °C}$
2. Test Signal: Pulse Width =  $100\text{ }\mu\text{s}$ , Duty Cycle = 20 %

**Application Circuit**

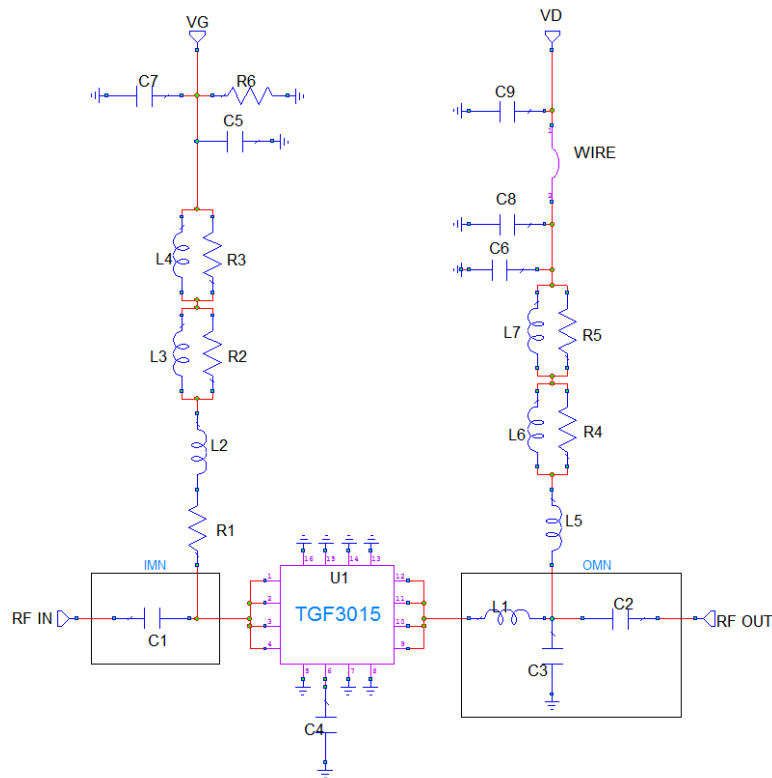

**Bias-up Procedure**

- Set gate voltage ( $V_G$ ) to -5.0V
- Set drain voltage ( $V_D$ ) to 32 V
- Slowly increase  $V_G$  until quiescent  $I_D$  is 50 mA.
- Apply RF signal

**Bias-down Procedure**

- Turn off RF signal
- Turn off  $V_D$  and wait 1 second to allow drain capacitor dissipation
- Turn off  $V_G$



## Evaluation Board Layout

Top RF layer is 0.020" thick Rogers RO4350B,  $\epsilon_r = 3.48$ . The pad pattern shown has been developed and tested for optimized assembly at TriQuint Semiconductor. The PCB land pattern has been developed to accommodate lead and package tolerances.

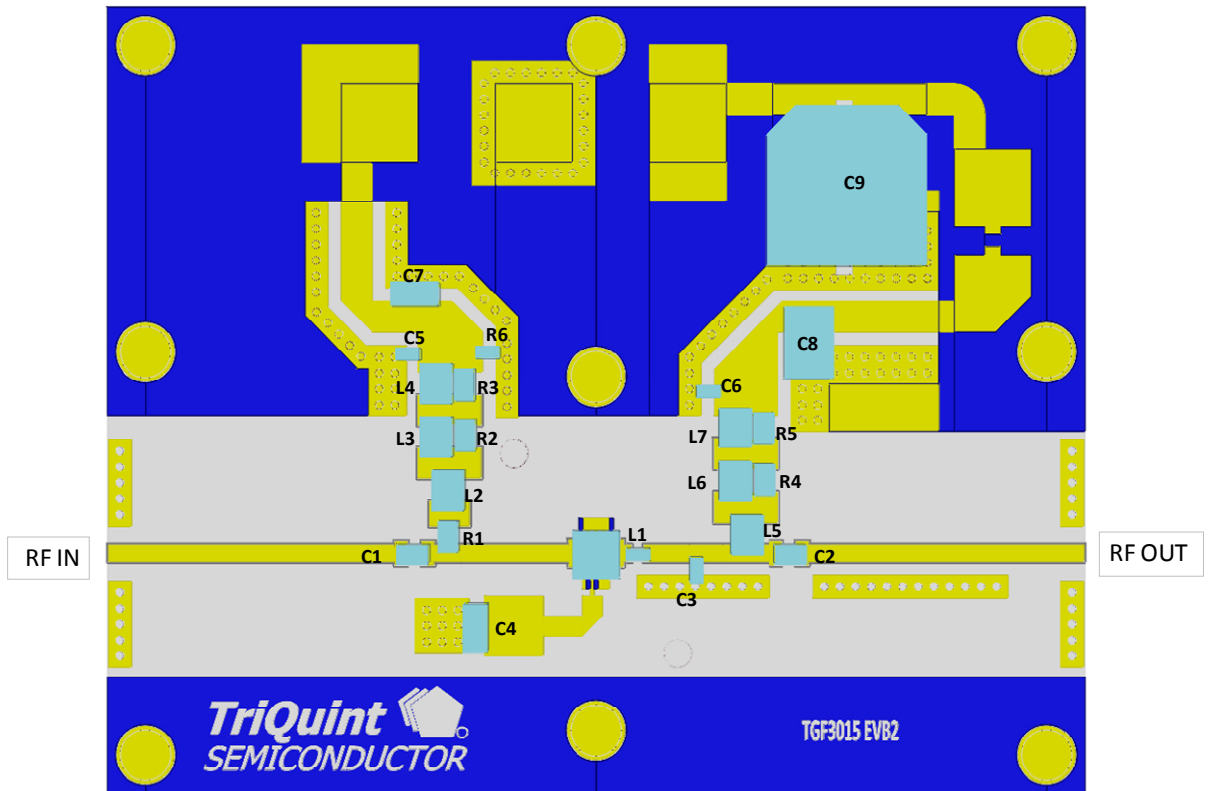

## Bill of Materials

Reference Design	Value	Qty	Manufacturer	Part Number
R1	500Ω	1		Generic 0603
R2, R3, R4, R5	400Ω	4		Generic 0603
R6	1kΩ	1		Generic 0603
C1, C2, C5, C6	2400pF	4	Dielectric Labs	C08BL242X-5UN-X0B
C3	0.5pF	1	ATC	600S005BT250XT
C4, C7	10uF	2	TDK	C1632X5R0J106M130AC
C8	1uF	1	AVX	18121C105KAT2A
C9	220uF		United Chemicon	EMVY500ADA221MJA0G
L1	1.6nH	1	CoilCraft	0603HC-1N6XJLU
L2, L5	82nH	2	CoilCraft	1008CS-820XGLB
L3, L6	100nH	2	CoilCraft	1008CS-101XGLB
L4, L7	900nH	2	CoilCraft	1008AF-901XJLB

## Pin Layout

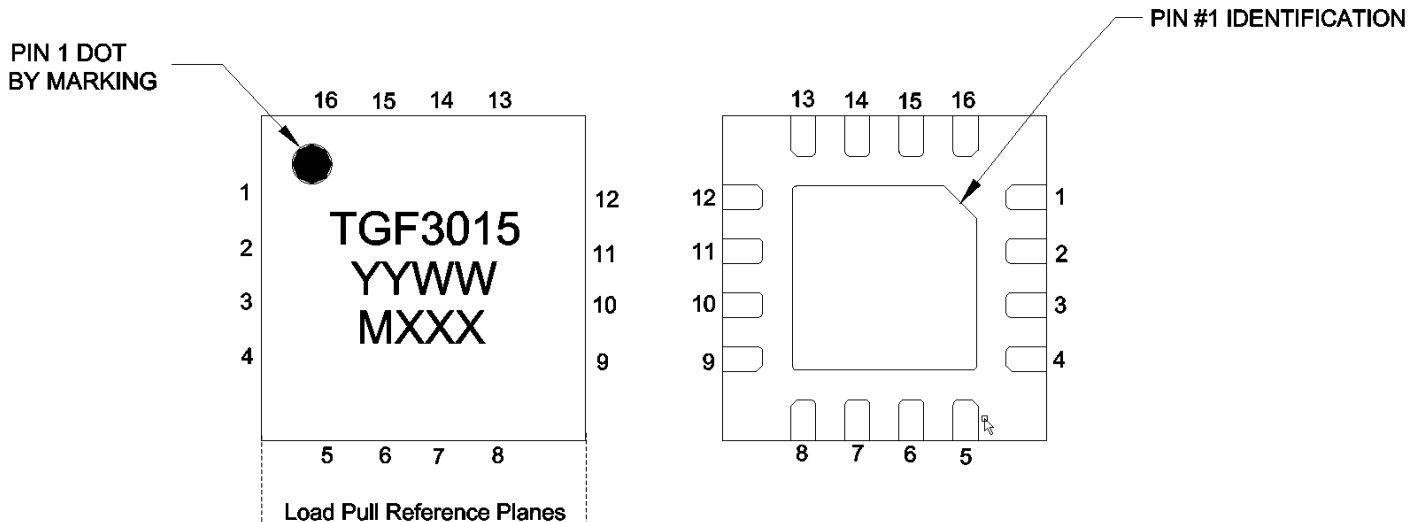

## Pin Description

Pin	Symbol	Description
9, 10, 11, 12	$V_D$ / RF OUT	Drain voltage / RF Output to be matched to 50 ohms; see EVB Layout on page 17 as an example.
3	$V_G$ / RF IN	Gate voltage / RF Input to be matched to 50 ohms; see EVB Layout on page 17 as an example.
6	Off-Chip Cap	Off-chip cap to extend low frequency gain.
Back side	Source	Source connected to ground

Notes:

Thermal resistance measured to back side of package

The TGF3015-SM will be marked with the "TGF3015" designator and a lot code marked below the part designator. The "YY" represents the last two digits of the calendar year the part was manufactured, the "WW" is the work week of the assembly lot start, and the "MXXX" is the production lot number.

**Mechanical Information**

All dimensions are in millimeters.

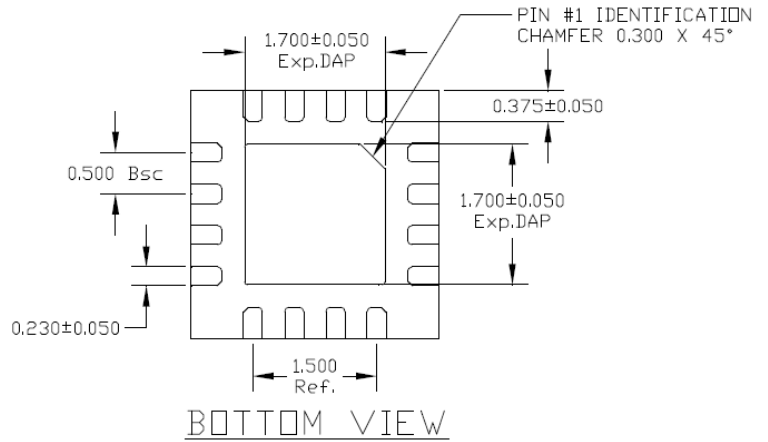
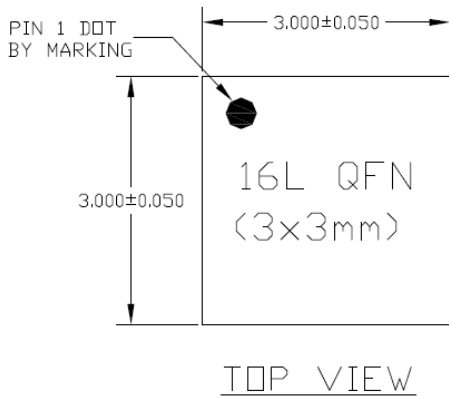

		QFN
A	MAX.	0.900
	NOM.	0.850
	MIN.	0.800

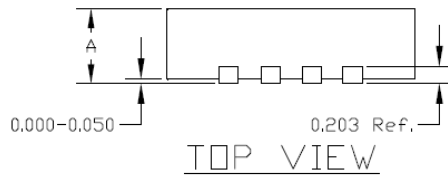

**Note:**

Unless otherwise noted, all dimension tolerances are +/-0.127 mm.  
 This package is lead-free/RoHS-compliant. The plating material on the leads is NiAu. It is compatible with both lead-free (maximum 260 °C reflow temperature) and tin-lead (maximum 245 °C reflow temperature) soldering processes.

**Product Compliance Information**

**ESD Sensitivity Ratings**



Caution! ESD-Sensitive Device

ESD Rating: TBD  
 Value: Passes  $\geq$  TBD V min.  
 Test: Human Body Model (HBM)  
 Standard: JEDEC Standard JESD22-A114

**MSL Rating**

The part is rated Moisture Sensitivity Level 3 at 260°C per JEDEC standard IPC/JEDEC J-STD-020.

**ECCN**

US Department of Commerce EAR99

**Solderability**

Compatible with the latest version of J-STD-020, Lead free solder, 260° C

**RoHs Compliance**

This part is compliant with EU 2002/95/EC RoHS directive (Restrictions on the Use of Certain Hazardous Substances in Electrical and Electronic Equipment).

This product also has the following attributes:

- Lead Free
- Halogen Free (Chlorine, Bromine)
- Antimony Free
- TBBP-A (C<sub>15</sub>H<sub>12</sub>Br<sub>4</sub>O<sub>2</sub>) Free
- PFOS Free
- SVHC Free

**Recommended Soldering Temperature Profile**

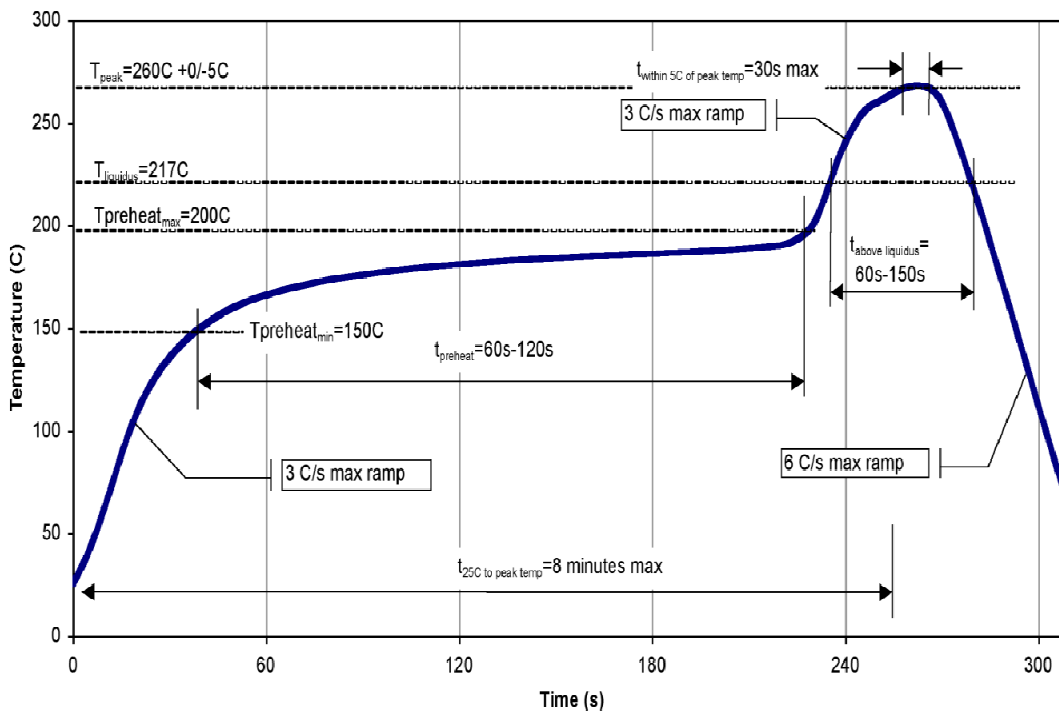

## Contact Information

For the latest specifications, additional product information, worldwide sales and distribution locations, and information about TriQuint:

**Web:** [www.triquint.com](http://www.triquint.com)

**Tel:** +1.972.994.8465

**Email:** [info-sales@triquint.com](mailto:info-sales@triquint.com)

**Fax:** +1.972.994.8504

For technical questions and application information:

**Email:** [info-products@triquint.com](mailto:info-products@triquint.com)

## Important Notice

The information contained herein is believed to be reliable. TriQuint makes no warranties regarding the information contained herein. TriQuint assumes no responsibility or liability whatsoever for any of the information contained herein. TriQuint assumes no responsibility or liability whatsoever for the use of the information contained herein. The information contained herein is provided "AS IS, WHERE IS" and with all faults, and the entire risk associated with such information is entirely with the user. All information contained herein is subject to change without notice. Customers should obtain and verify the latest relevant information before placing orders for TriQuint products. The information contained herein or any use of such information does not grant, explicitly or implicitly, to any party any patent rights, licenses, or any other intellectual property rights, whether with regard to such information itself or anything described by such information.

TriQuint products are not warranted or authorized for use as critical components in medical, life-saving, or life-sustaining applications, or other applications where a failure would reasonably be expected to cause severe personal injury or death.