

RF Power MOSFET Transistor 5W, 100-500 MHz, 28V

M/A-COM Products
Released; RoHS Compliant

Features

- N-channel enhancement mode device
- DMOS structure
- Lower capacitances for broadband operation
- Common source configuration
- Lower noise floor
- 100 MHz to 500 MHz operation

ABSOLUTE MAXIMUM RATINGS AT 25° C

Parameter	Symbol	Rating	Units
Drain-Source Voltage	V_{DS}	65	V
Gate-Source Voltage	V_{GS}	20	V
Drain-Source Current	I_{DS}	1.4	A
Power Dissipation	P_D	14.4	W
Junction Temperature	T_J	200	°C
Storage Temperature	T_{STG}	-55 to +150	°C
Thermal Resistance	θ_{JC}	12.1	°C/W

TYPICAL DEVICE IMPEDANCES

F (MHz)	Z_{IN} (Ω)	Z_{LOAD} (Ω)
100	15.0-j8.0	35.0+j55.0
300	8.0-j43.0	29.0+j40.0
500	4.0-j29.0	28.0-j29.0
$V_{DD}=28V, I_{DQ}=50\text{ Ma}, P_{OUT}=100.0\text{ W}$		

Z_{IN} is the series equivalent input impedance of the device from gate to source.

Z_{LOAD} is the optimum series equivalent load impedance as measured from drain to drain.

ELECTRICAL CHARACTERISTICS AT 25°C

Parameter	Symbol	Min	Max	Units	Test Conditions
Drain-Source Breakdown Voltage	BV_{DSS}	65	-	V	$V_{GS} = 0.0\text{ V}, I_{DS} = 2.0\text{ mA}$
Drain-Source Leakage Current	I_{DSS}	-	1.0	mA	$V_{GS} = 28.0\text{ V}, V_{DS} = 0.0\text{ V}$
Gate-Source Leakage Current	I_{GSS}	-	1.0	μA	$V_{GS} = 20.0\text{ V}, V_{DS} = 0.0\text{ V}$
Gate Threshold Voltage	$V_{GS(TH)}$	2.0	6.0	V	$V_{DS} = 10.0\text{ V}, I_{DS} = 10.0\text{ mA}$
Forward Transconductance	G_M	80	-	S	$V_{DS} = 10.0\text{ V}, I_{DS} = 1.0\text{ mA}, \Delta V_{GS} = 1.0V, 80\ \mu\text{s Pulse}$
Input Capacitance	C_{ISS}	-	7.0	pF	$V_{DS} = 28.0\text{ V}, F = 1.0\text{ MHz}$
Output Capacitance	C_{OSS}	-	5	pF	$V_{DS} = 28.0\text{ V}, F = 1.0\text{ MHz}$
Reverse Capacitance	C_{RSS}	-	2.4	pF	$V_{DS} = 28.0\text{ V}, F = 1.0\text{ MHz}$
Power Gain	G_P	10	-	dB	$V_{DD} = 28.0\text{ V}, I_{DQ} = 50\text{ mA}, P_{OUT} = 5.0\text{ W } F = 500\text{ MHz}$
Drain Efficiency	η_D	50	-	%	$V_{DD} = 28.0\text{ V}, I_{DQ} = 50\text{ mA}, P_{OUT} = 5.0\text{ W } F = 500\text{ MHz}$
Load Mismatch Tolerance	VSWR-T	-	20:1	-	$V_{DD} = 28.0\text{ V}, I_{DQ} = 50\text{ mA}, P_{OUT} = 5.0\text{ W } F = 500\text{ MHz}$

Package Outline

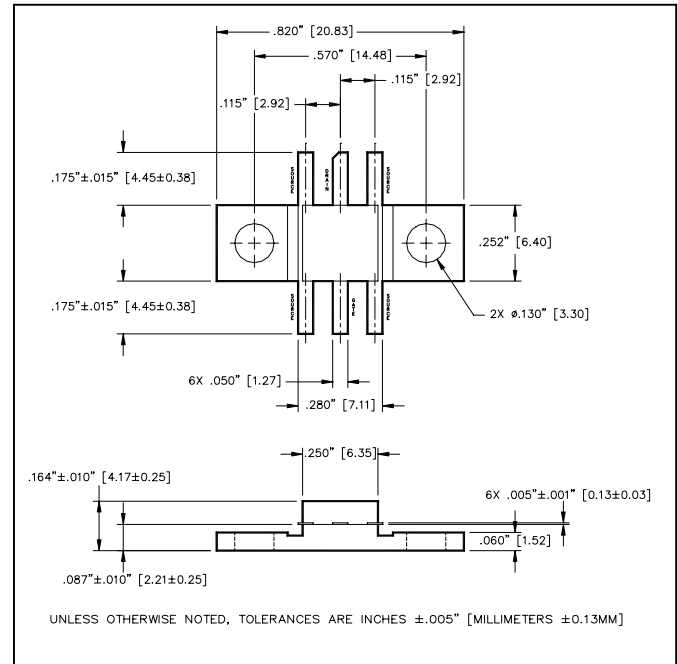

Typical Broadband Performance Curves

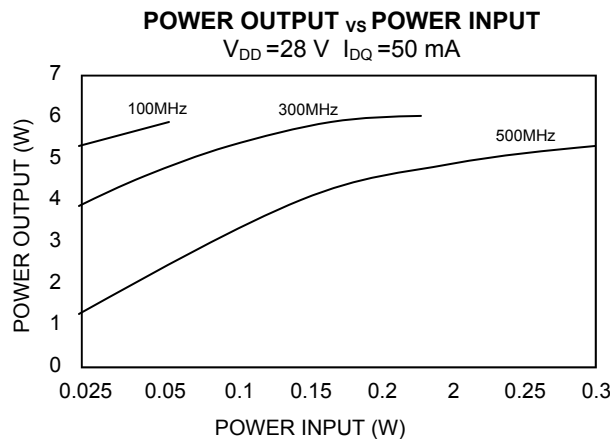
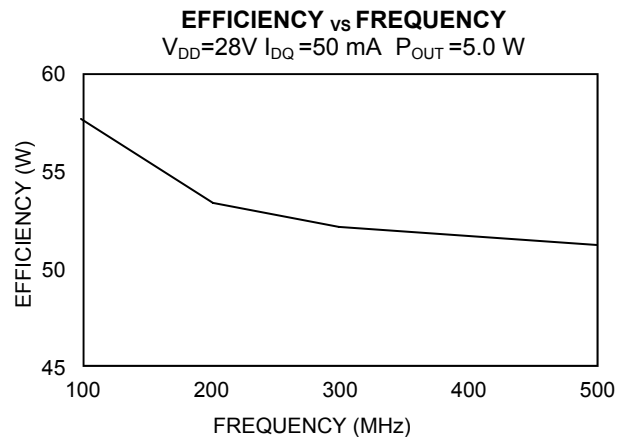
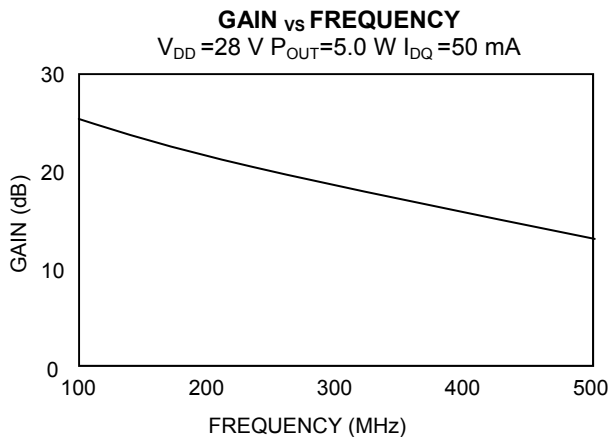
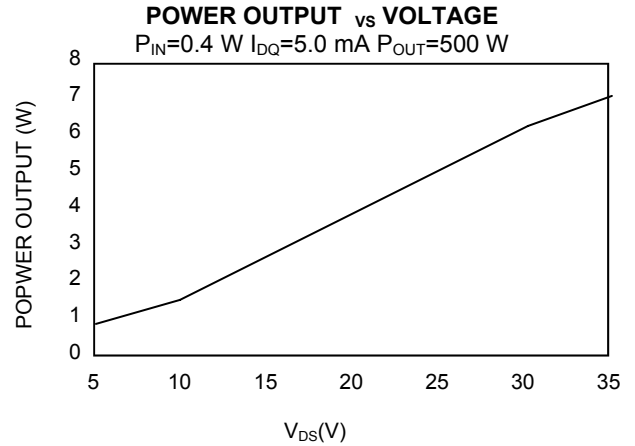
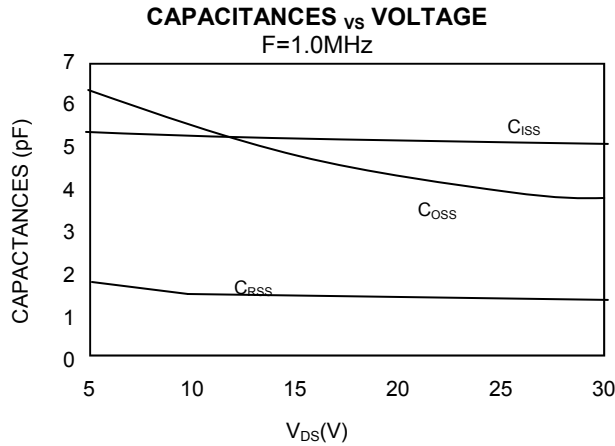

UF2805B

RF Power MOSFET Transistor
5W, 100-500 MHz, 28V

M/A-COM Products
Released; RoHS Compliant

TEST FIXTURE SCHEMATIC

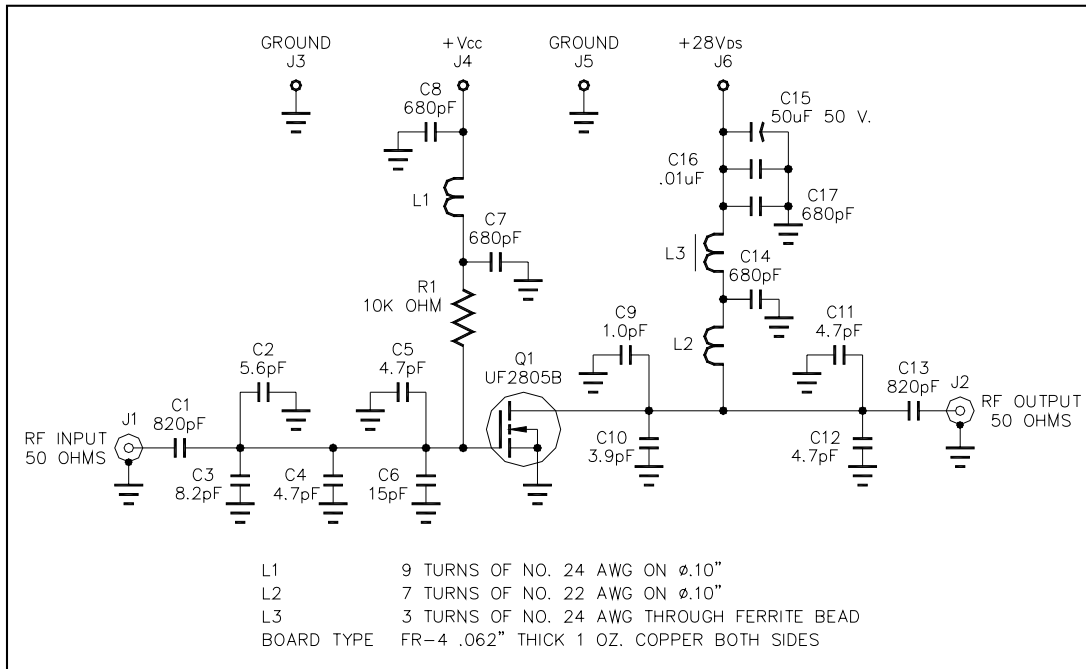

TEST FIXTURE ASSEMBLY

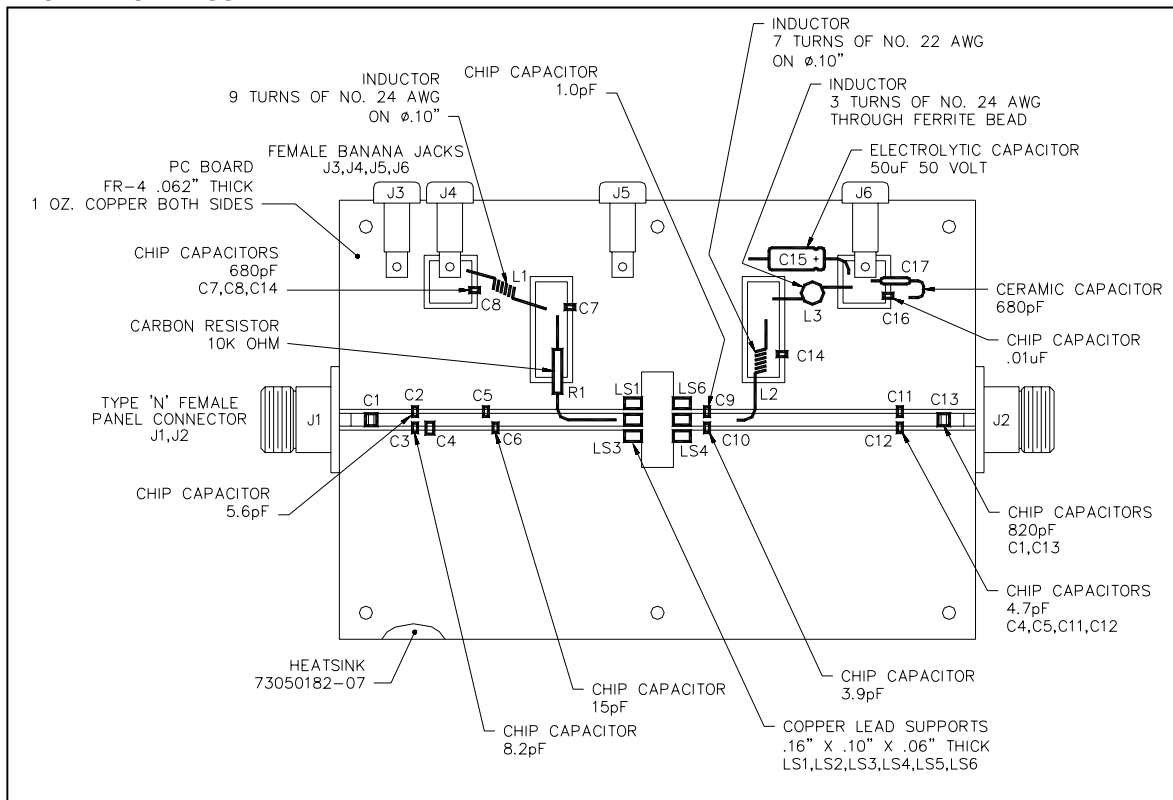

ADVANCED: Data Sheets contain information regarding a product M/A-COM Technology Solutions is considering for development. Performance is based on target specifications, simulated results, and/or prototype measurements. Commitment to develop is not guaranteed.
PRELIMINARY: Data Sheets contain information regarding a product M/A-COM Technology Solutions has under development. Performance is based on engineering tests. Specifications are typical. Mechanical outline has been fixed. Engineering samples and/or test data may be available. Commitment to produce in volume is not guaranteed.

- **North America** Tel: 800.366.2266 / Fax: 978.366.2266
 - **Europe** Tel: 44.1908.574.200 / Fax: 44.1908.574.300
 - **Asia/Pacific** Tel: 81.44.844.8296 / Fax: 81.44.844.8298
- Visit www.macomtech.com for additional data sheets and product information.

M/A-COM Technology Solutions Inc. and its affiliates reserve the right to make changes to the product(s) or information contained herein without notice.