

# 4.5-10.5 GHz GaAs MMIC Receiver

## Features

- ✕ Integrated LNA, Mixer and LO Buffer Amp
- ✕ 1.6 dB Noise Figure
- ✕ 14.0 dB Conversion Gain
- ✕ BCB Coated Die
- ✕ 100% RF, DC and NF Testing
- ✕ 100% Commercial-Level Visual Inspection Using Mil-Std-883 Method 2010

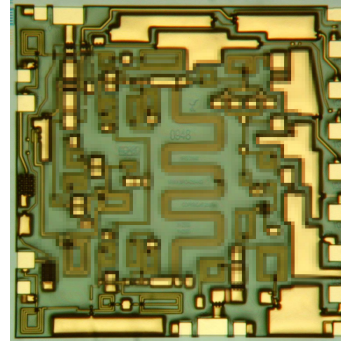

## General Description

Mimix Broadband's 4.5-10.5 GHz receiver has a noise figure of 1.6 dB and 14.0 dB conversion gain across the band. The device integrates an LNA, image reject mixer and LO buffer amplifier within a single, compact MMIC. The image reject mixer eliminates the need for a bandpass filter after the LNA to remove thermal noise at the image frequency. I and Q mixer outputs are provided and an external 90 degree hybrid is required to select the desired sideband. This device uses Mimix Broadband's GaAs PHEMT device model technology, and is based upon electron beam lithography to ensure high repeatability and uniformity. This device is well suited for Point-to-Point Radio, LMDS, SATCOM and VSAT applications.

## Absolute Maximum Ratings<sup>1</sup>

Supply Voltage (Vdd)	+5.0 VDC
Supply Current (Idd)	180 mA
Gate Voltage (Vgg)	-3 V
Max Power Dissipation (Pdiss)	750 mW
RF Input Power (Pin)	+14 dBm
LO Input Power (Pin)	+15 dBm
Operating Temperature (Ta)	-55 to +85 °C
Storage Temperature (Tstg)	-65 to +150 °C
Channel Temperature (Tch)	-40 to MTTF Graph <sup>2</sup>

(1) Operation of this device above any one of these parameters may cause permanent damage

(2) Channel temperature directly affects a device's MTTF. Channel temperature should be kept as low as possible to maximize lifetime

## Electrical Characteristics (Ambient Temperature T = 25 °C)

Parameter	Units	Min.	Typ.	Max.
Frequency Range (RF/LO)	GHz	4.5	-	10.5
Frequency Range (IF)	GHz	DC	-	3.5
Conversion Gain (CG)	dB		14.0	
Noise Figure (NF)	dB		1.6	
Input Third Order Intercept (IIP3)	dBm		2.0	
Image Rejection	dBc	15.0	20.0	
LO Input Drive	dBm		5.0	
LO/RF Isolation	dB		50.0	
RF Input Return Loss	dB		10.0	
LO Input Return Loss	dB		10.0	
IF Input Return Loss	dB		10.0	
Drain Bias Voltage (Vd1,2,3)	VDC		4.0	4.5
Gate Bias Voltage (Vg1,2,3)*	VDC	-1.2	-0.3	0.2
Gate Bias Voltage (Vg4)**	VDC		-2.0	
Supply Current (Id1)	mA		25.0	
Supply Current (Id2)	mA		45.0	
Supply Current (Id3)	mA		60.0	
Supply Current (Ig4)	mA		2.0	

\*Vg1,2 and 3 are adjusted to achieve constant drain current regulation.

\*\*Vg4 provides mixer bias and is fixed at -2.0V.

# 4.5-10.5 GHz GaAs MMIC Receiver

## Receiver Measurements

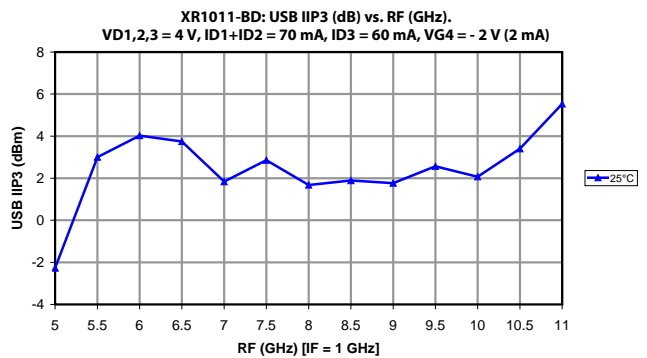
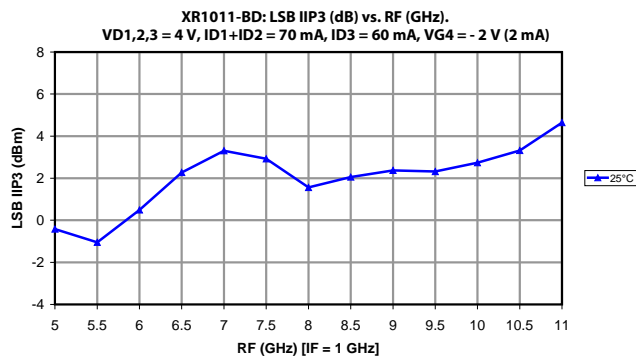
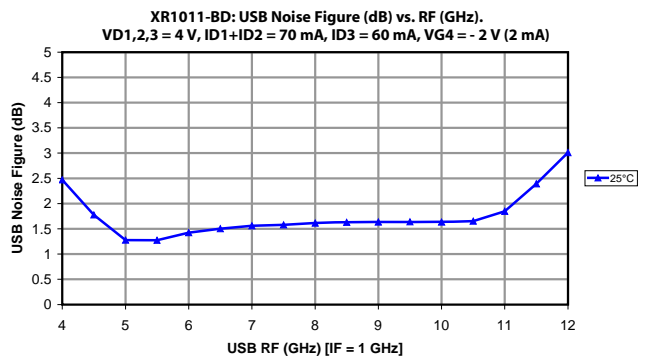
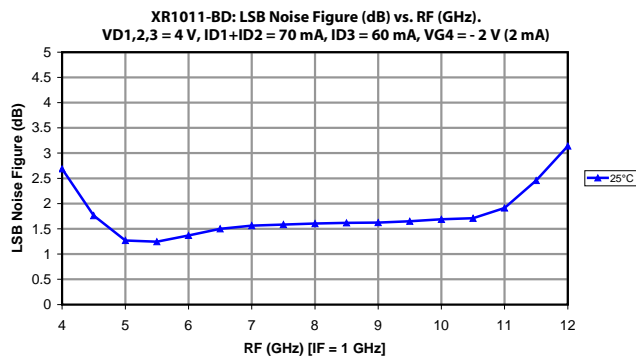
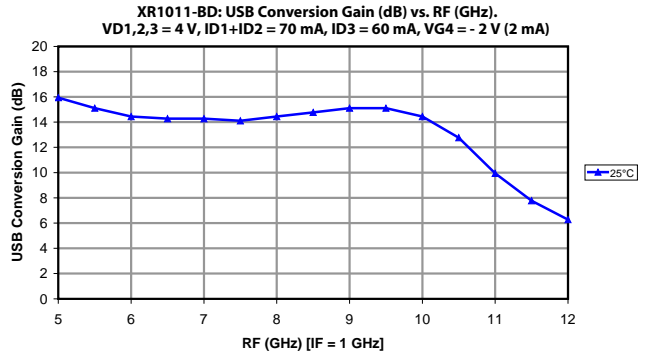
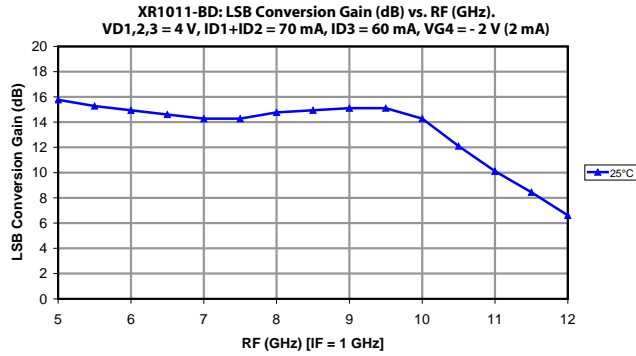

# 4.5-10.5 GHz GaAs MMIC Receiver

## Receiver Measurements (cont.)

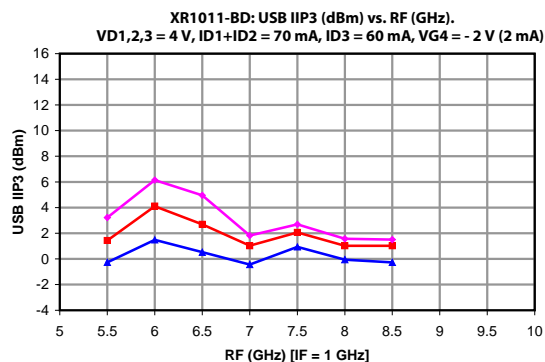
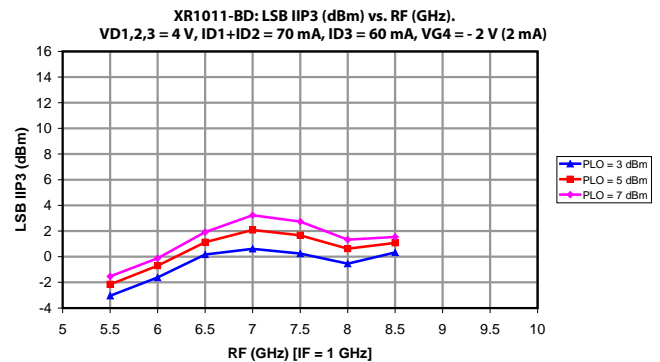
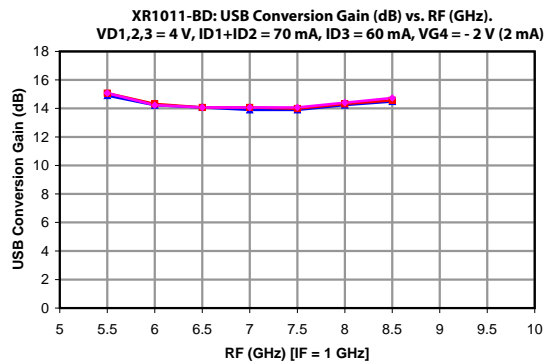
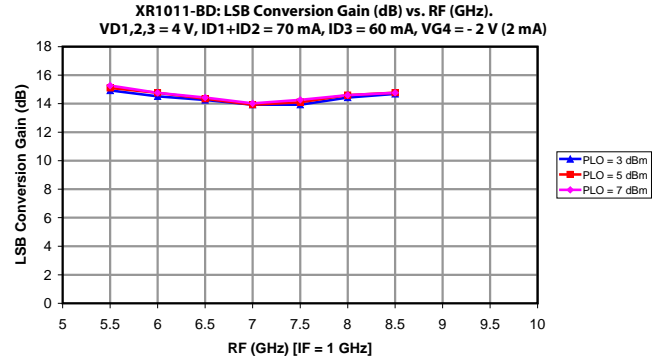
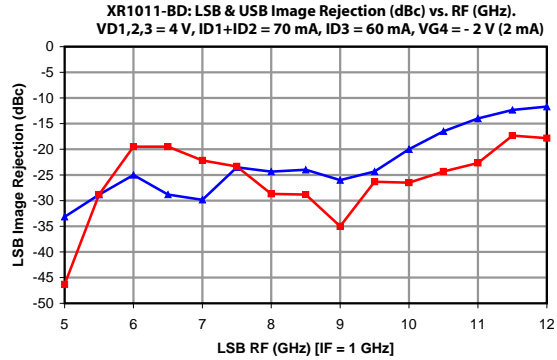

# 4.5-10.5 GHz GaAs MMIC Receiver

October 2008 - Rev 16-Oct-08

**App Note [1] Biasing** - The device is operated by biasing VD1,2,3 at 4.0V with 25, 45, 60mA respectively. Additionally, a fixed voltage bias of -2V is required for mixer bias. It is recommended to use active bias to keep the currents constant in order to maintain the best performance over temperature. Depending on the supply voltage available and the power dissipation constraints, the bias circuit may be a single transistor or a low power operational amplifier, with a low value resistor in series with the drain supply used to sense the current. The gate of the pHEMT is controlled to maintain correct drain current and thus drain voltage. The typical gate voltage needed to do this is -0.3V. Make sure to sequence the applied voltage to ensure negative gate bias is available before applying the positive drain supply.

**App Note [2] Board Layout** - It is recommended to provide 100pF decoupling caps as close to the bias pads as possible, with additional 10µF decoupling caps.

## Functional Schematic

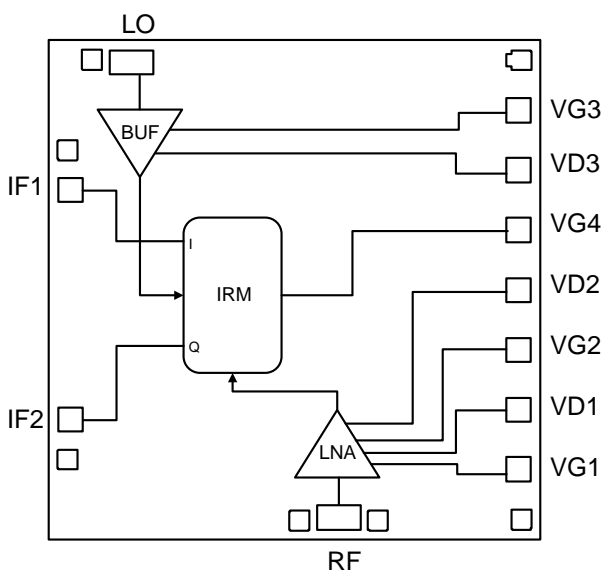

## Pad Designation

Pad Number	Pin Name	Pin Function	Nominal Value
1	IF2	IF2 Output	To Hybrid 90° (LSB) To Hybrid 0° (USB)
2	IF1	IF1 Output	To Hybrid 90° (LSB) To Hybrid 0° (USB)
3	LO	LO Input	+5.0 dBm
4	VG3	Gate 3 Bias	-0.3V
5	VD3	Drain 3 Bias	4.0V, 60 mA
6	VG4	Gate 4 Bias	-2.0V, 2 mA
7	VD2	Drain 2 Bias	4.0V, 45 mA
8	VG2	Gate 2 Bias	-0.3V
9	VD1	Drain 1 Bias	4.0V, 25 mA
10	VG1	Gate 1 Bias	-0.3V
11	RF	RF Input	

## Mechanical Dimensions

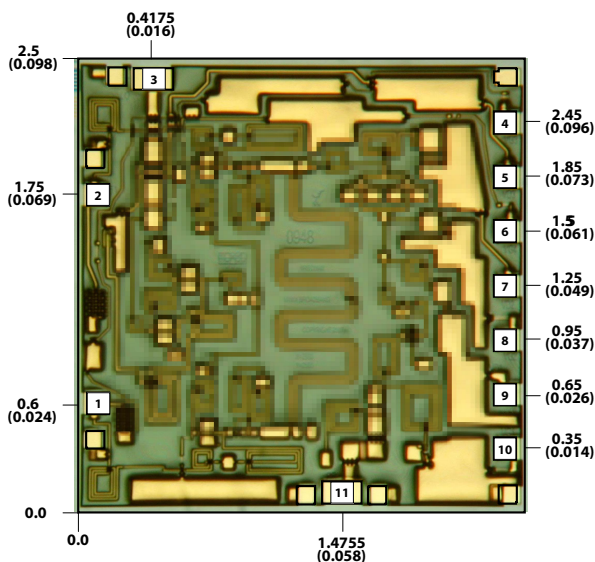

# 4.5-10.5 GHz GaAs MMIC Receiver

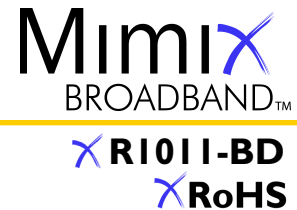

October 2008 - Rev 16-Oct-08

## Handling and Assembly Information

**CAUTION!** - Mimix Broadband MMIC Products contain gallium arsenide (GaAs) which can be hazardous to the human body and the environment. For safety, observe the following procedures:

- Do not ingest.
- Do not alter the form of this product into a gas, powder, or liquid through burning, crushing, or chemical processing as these by-products are dangerous to the human body if inhaled, ingested, or swallowed.
- Observe government laws and company regulations when discarding this product. This product must be discarded in accordance with methods specified by applicable hazardous waste procedures.

**Life Support Policy** - Mimix Broadband's products are not authorized for use as critical components in life support devices or systems without the express written approval of the President and General Counsel of Mimix Broadband. As used herein: (1) Life support devices or systems are devices or systems which, (a) are intended for surgical implant into the body, or (b) support or sustain life, and whose failure to perform when properly used in accordance with instructions for use provided in the labeling, can be reasonably expected to result in a significant injury to the user. (2) A critical component is any component of a life support device or system whose failure to perform can be reasonably expected to cause the failure of the life support device or system, or to affect its safety or effectiveness.

**ESD** - Gallium Arsenide (GaAs) devices are susceptible to electrostatic and mechanical damage. Die are supplied in antistatic containers, which should be opened in cleanroom conditions at an appropriately grounded anti-static workstation. Devices need careful handling using correctly designed collets, vacuum pickups or, with care, sharp tweezers.

**Die Attachment** - GaAs Products from Mimix Broadband are 0.100 mm (0.004") thick and have vias through to the backside to enable grounding to the circuit. Microstrip substrates should be brought as close to the die as possible. The mounting surface should be clean and flat. If using conductive epoxy, recommended epoxies are Tanaka TS3332LD, Die Mat DM6030HK or DM6030HK-Pt cured in a nitrogen atmosphere per manufacturer's cure schedule. Apply epoxy sparingly to avoid getting any on to the top surface of the die. An epoxy fillet should be visible around the total die periphery. For additional information please see the Mimix "Epoxy Specifications for Bare Die" application note. If eutectic mounting is preferred, then a fluxless gold-tin (AuSn) preform, approximately 0.001" thick, placed between the die and the attachment surface should be used. A die bonder that utilizes a heated collet and provides scrubbing action to ensure total wetting to prevent void formation in a nitrogen atmosphere is recommended. The gold-tin eutectic (80% Au 20% Sn) has a melting point of approximately 280° C (Note: Gold Germanium should be avoided). The work station temperature should be 310° C +/- 10° C. Exposure to these extreme temperatures should be kept to minimum. The collet should be heated, and the die pre-heated to avoid excessive thermal shock. Avoidance of air bridges and force impact are critical during placement.

**Wire Bonding** - Windows in the surface passivation above the bond pads are provided to allow wire bonding to the die's gold bond pads. The recommended wire bonding procedure uses 0.076 mm x 0.013 mm (0.003" x 0.0005") 99.99% pure gold ribbon with 0.5-2% elongation to minimize RF port bond inductance. Gold 0.025 mm (0.001") diameter wedge or ball bonds are acceptable for DC Bias connections. Aluminum wire should be avoided. Thermo-compression bonding is recommended though thermosonic bonding may be used providing the ultrasonic content of the bond is minimized. Bond force, time and ultrasonics are all critical parameters. Bonds should be made from the bond pads on the die to the package or substrate. All bonds should be as short as possible.

## Ordering Information

Part Number for Ordering	Description
XR1011-BD-000V	"V" - vacuum release gel paks
XR1011-BD-EV1	XR1011 die evaluation module



Proper ESD procedures should be followed when handling this device.

Mimix Broadband, Inc., 10795 Rockley Rd., Houston, Texas 77099  
Tel: 281.988.4600 Fax: 281.988.4615 mimixbroadband.com

Page 5 of 5

Characteristic Data and Specifications are subject to change without notice. ©2008 Mimix Broadband, Inc.  
Export of this item may require appropriate export licensing from the U.S. Government. In purchasing these parts, U.S. Domestic customers accept their obligation to be compliant with U.S. Export Laws.