

# TGV2529-SM

12.5 – 13.5 GHz VCO with Divide by 2



## Applications

- Point to Point Radio / VSAT
- Millimeter-wave Communications
- Test Equipment

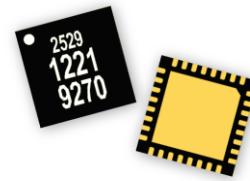

32-pin 5x5mm package

## Product Features

- Frequency range: 12.5 – 13.5 GHz
- Tune Voltage: 1 – 13 V
- Output power: 7 dBm Typical
- Phase Noise: -110 dBc/Hz@100 KHz Typical  
-133 dBc/Hz@1 MHz Typical
- RFout/2 Frequency Range: 6.25 – 6.75 GHz
- RFout/2 Output Power: 6 dBm Typical
- Bias: Vcc = 5V, Icc = 165 mA Typical
- Technology: TriQuint HBT
- Dimension: 5 x 5 x 0.85 mm SLP

## Functional Block Diagram

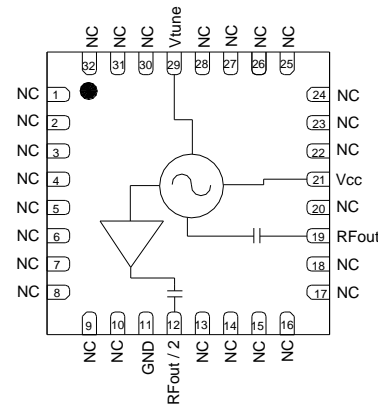

## General Description

The TriQuint TGV2529-SM is a monolithic voltage controlled oscillator (VCO) designed to operate at frequencies that target the Point to Point, VSAT, and millimeter-wave communication markets.

The TGV2529-SM is manufactured on TriQuint's GaAs InGaP production process and typically provides 7 dBm output power at 13GHz with a -110dBc/Hz phase noise at 100 KHz offset. A divide-by-2 output is provided for the PLL function.

Lead-free and RoHS compliant.

Evaluation Boards are available upon request.

## Pin Configuration

Pin #	Function Label
11	GND
12	RFout/2
19	RFout
21	Vcc
29	Vtune
1, 2, 3, 4, 5, 6, 7, 8, 9, 10, 13, 14, 15, 16, 17, 18, 20, 22, 23, 24, 25, 26, 27, 28, 30, 31, 32	NC

## Ordering Information

Part No.	ECCN	Description
TGV2529-SM	EAR99	12.5 – 13.5 GHz VCO with Divide by 2

Standard T/R size = 500 pieces on a 7.0" reel.

# TGV2529-SM

12.5 – 13.5 GHz VCO with Divide by 2



## Specifications

### Absolute Maximum Ratings

Parameter	Rating
Supply Voltage, Vcc	+5.5V
Tuning Voltage, Vtune	+14V
Power Dissipation, Pdiss	1.1W
Junction Temperature	200°C
Storage Temperature	-65 to 125°C

Operation of this device outside the parameter ranges given above may cause permanent damage.

### Recommended Operating Conditions

Parameter	Min	Typ	Max	Units
Operating Temp. Range	-40	+25	+85	°C
Supply Voltage, Vcc	4.8	5.0	5.2	V
Supply Current, Icc		165		mA
Tuning Voltage, Vtune	1		12	V

Electrical specifications are measured at specified test conditions. Specifications are not guaranteed over all recommended operating conditions.

### Electrical Specifications

Test conditions unless otherwise noted: 25 °C, Vcc = 5 V, Icc = 165mA

Parameter	Conditions	Min	Typ	Max	Units
Operational Frequency		12.5		13.5	GHz
RFout/2 Output Frequency		6.25		6.75	GHz
Supply Voltage, Vcc		4.8	5	5.2	V
Supply Current, Icc		140	165	190	mA
Output Power		4	7	12	dBm
RFout/2 Output Power		2	6	10	dBm
Tuning Sensitivity	Vtune = 5V		175		MHz/V
Output Return Loss			7		dB
RFout/2 Output Return Loss			5		dB
Tuning Voltage		1		13	V
Pushing	Vtune = 5V		10		MHz/V
Pulling	VSWR 2:1		5		MHz (p-p)
Harmonics					
Freq/2			21		dBc
3*Freq/2			30		
2*Freq			49		
Phase Noise @ 10KHz Offset	Vtune = 5V		-80		dBc/Hz
Phase Noise @ 100KHz Offset	Vtune = 5V		-110		dBc/Hz
Phase Noise @ 1MHz Offset	Vtune = 5V		-133		dBc/Hz
Frequency Drift Rate			1.1		MHz/°C
Vtune Leakage	Vtune = 12V		5		µA

### Specifications

#### Thermal and Reliability Information

Parameter	Condition	Rating
Thermal Resistance, $\theta_{JC}$ , measured to back of package	Tbase = 85 °C	$\theta_{JC}$ = 48 °C/W
Junction Temperature (Tj), and Median Lifetime (Tm)	Tbase = 85 °C Vd = 5V Id = 165mA	Tch = 125 °C Tm = 8.4 E+7 Hours

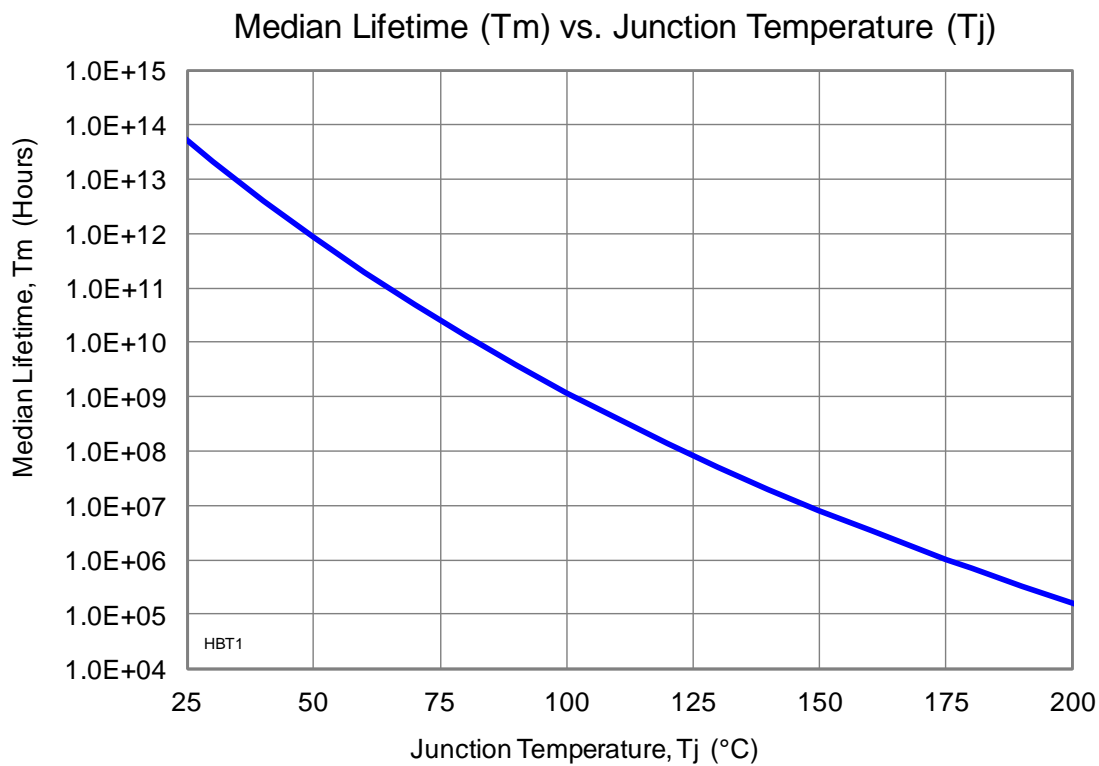

### Typical Performance

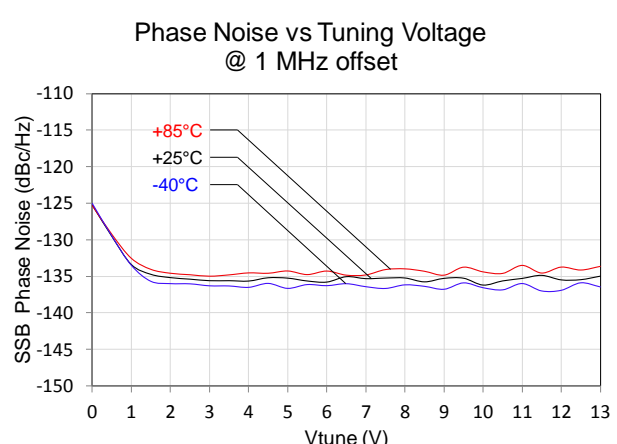
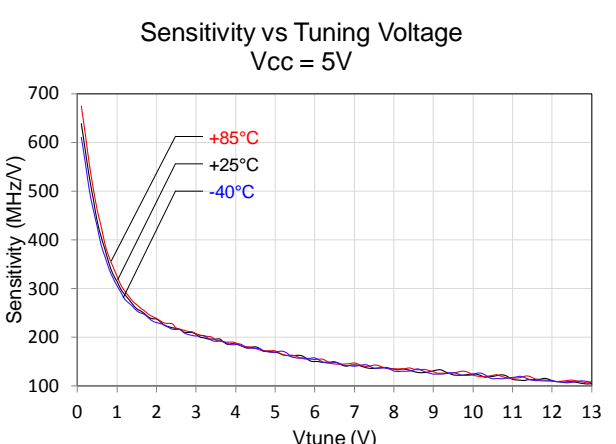
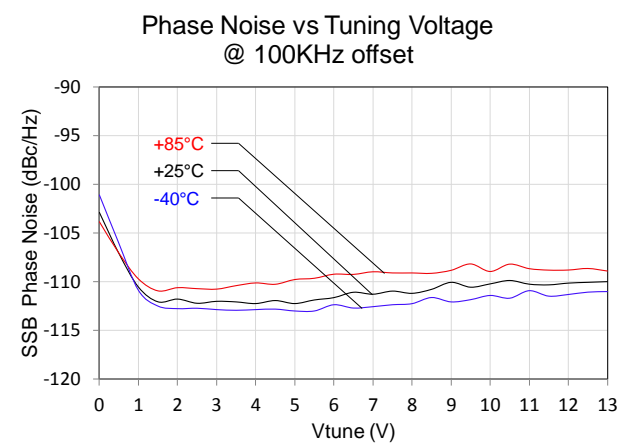
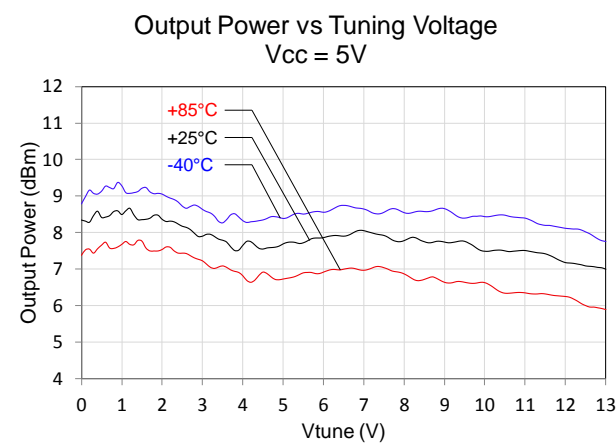
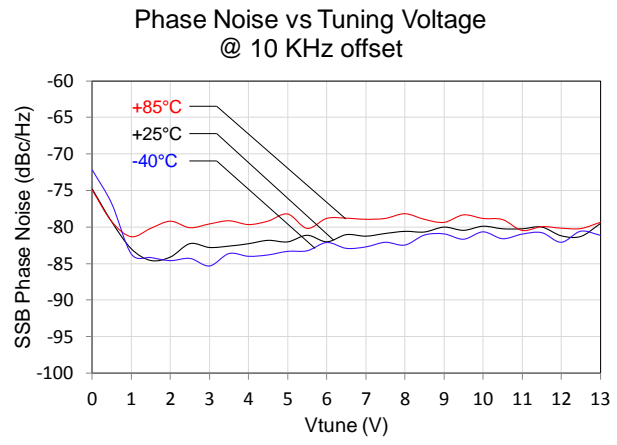
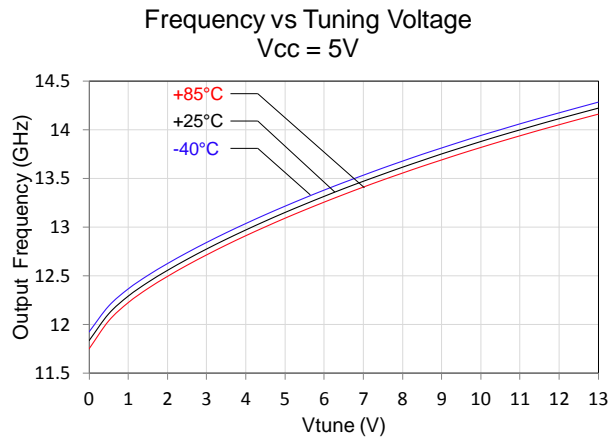

### Typical Performance

RFout/2 Frequency vs Tuning Voltage  
Vcc = 5V

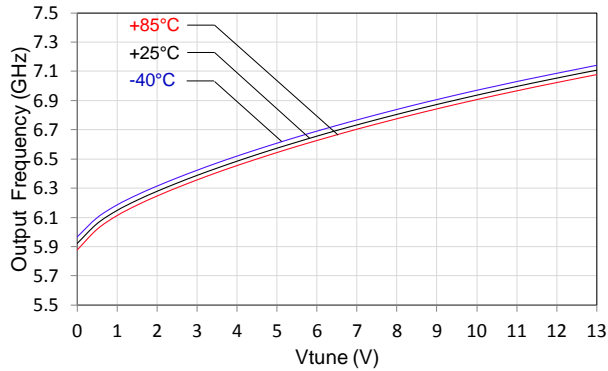

RFout/2 Phase Noise vs Tuning Voltage  
@ 10 KHz offset

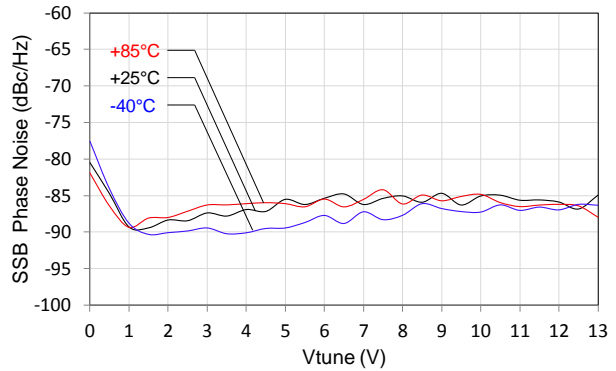

RFout/2 Output Power vs Tuning Voltage  
Vcc = 5V

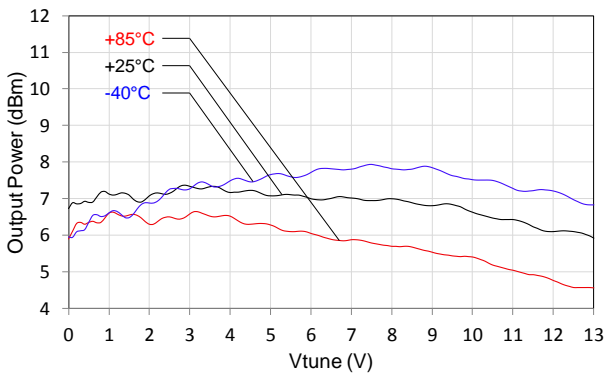

RFout/2 Phase Noise vs Tuning Voltage  
@ 100 KHz offset

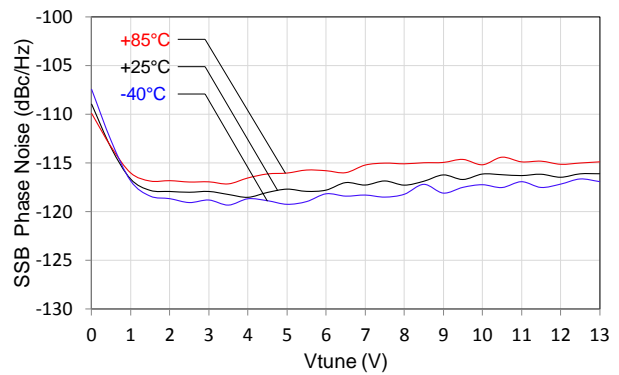

RFout/2 Sensitivity vs Tuning Voltage  
Vcc = 5V

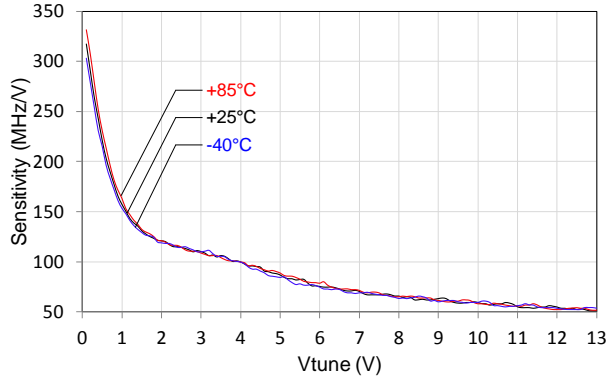

RFout/2 Phase Noise vs Tuning Voltage  
@ 1 MHz offset

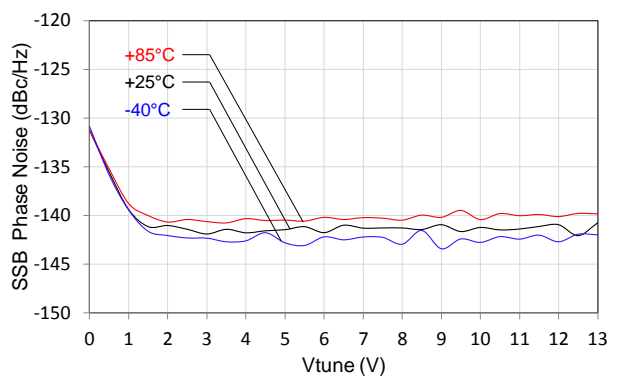

### Typical Performance

Phase Noise vs Tuning Voltage  
 $V_{CC} = 5V$

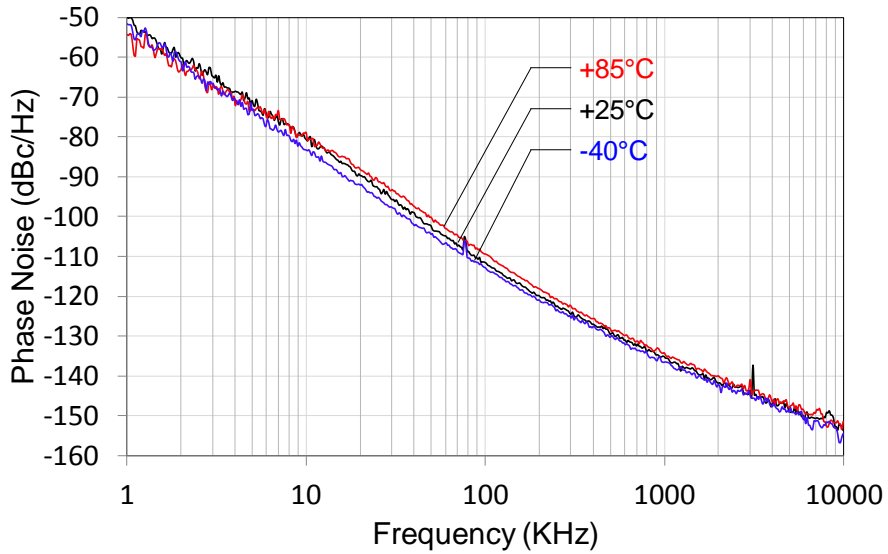

Pushing vs Tuning Voltage

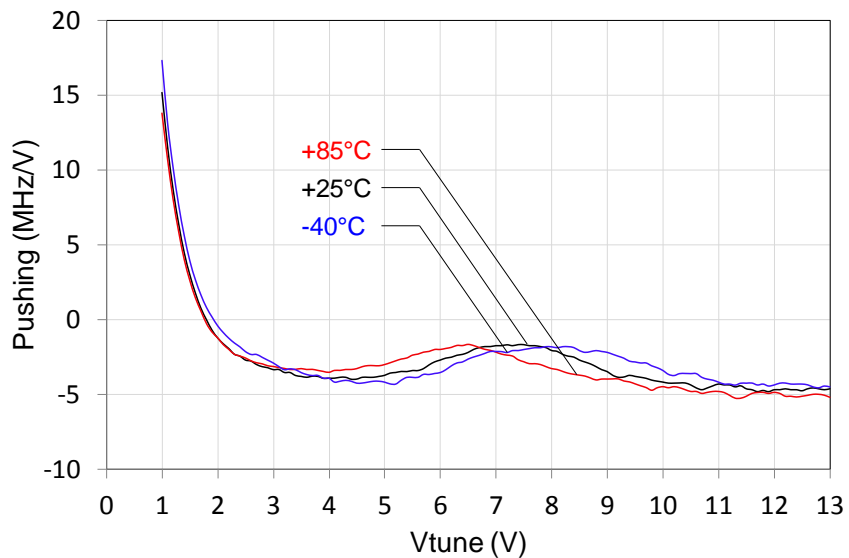

# TGV2529-SM

12.5 – 13.5 GHz VCO with Divide by 2

## Pin Description

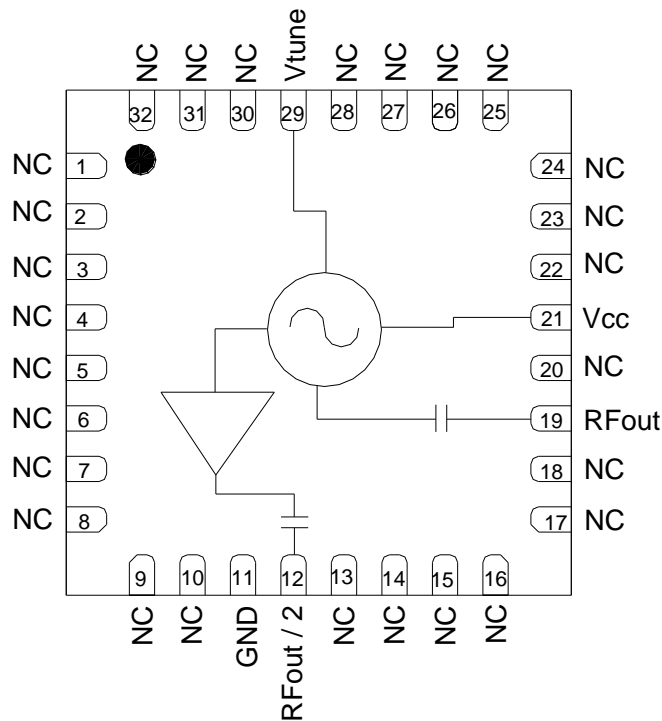

Pin	Symbol	Description
1, 2, 3, 4, 5, 6, 7, 8, 9, 10, 13, 14, 15, 16, 17, 18, 20, 22, 23, 24, 25, 26, 27, 28, 30, 31, 32	NC	No internal connection.
11	GND	Backside Paddle. Multiple vias should be employed to minimize inductance and thermal resistance
12	RFout/2	Frequency/2 Output match to 50 ohms, AC coupled
19	RFout	Output, matched to 50 ohms, AC coupled
21	Vcc	Supply voltage. Bias network is required; see Application Circuit on page 8 as an example.
29	Vtune	VCO tuning voltage.

# TGV2529-SM

12.5 – 13.5 GHz VCO with Divide by 2

## Application Circuit

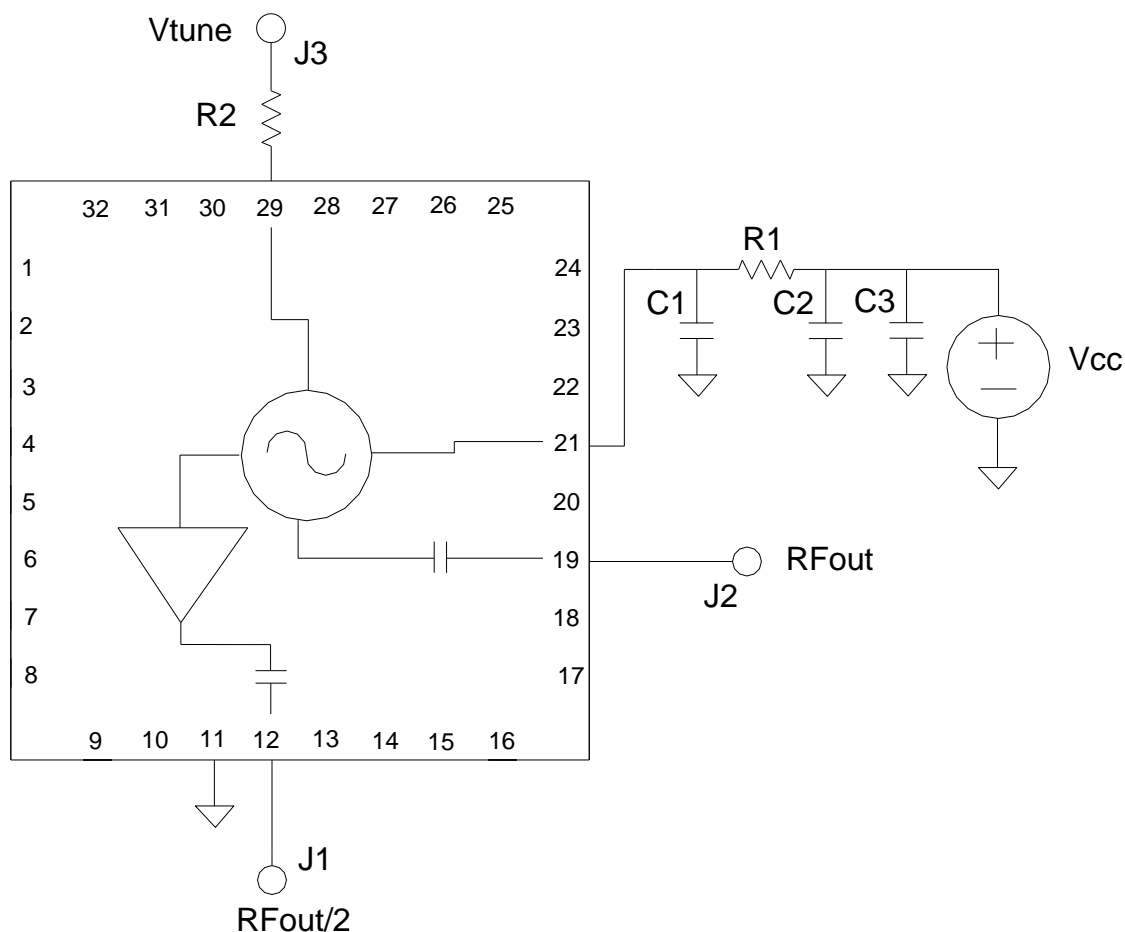



# TGV2529-SM

12.5 – 13.5 GHz VCO with Divide by 2

## Application Circuit

### PC Board Layout

Top RF layer is 0.008" thick Roger RO4003,  $\epsilon_r = 3.38$ . Microstrip 50Ω line detail: width = 0.0175". For further technical information, refer to the [TGV2529-SM](#) Product Information page.

The pad pattern shown has been developed and tested for optimized assembly at Triquint Semiconductor. The PCB land pattern has been developed to accommodate lead and package tolerance. Since surface mount processes vary from company to company, careful process development is recommended.

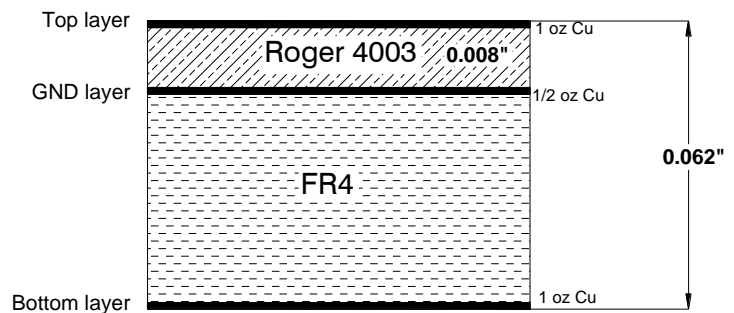
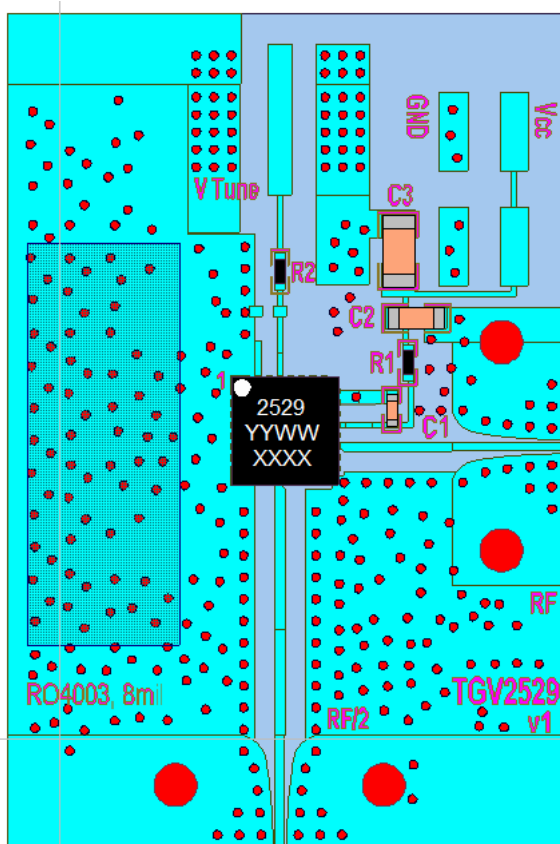

### Bill of Material

Ref Des	Value	Description	Manufacturer	Part Number
C1	100 pF	Ceramic Cap, 0402	various	
C2	1 μF	Ceramic Cap, 0603	various	
C3	10 μF	Tantalum Cap, 0805/1206	various	
R1, R2	0 ohm	Chip Res, 0402	various	



# TGV2529-SM

12.5 – 13.5 GHz VCO with Divide by 2

## Mechanical Information

### PCB Mounting Pattern

All dimensions are in millimeters [inches].

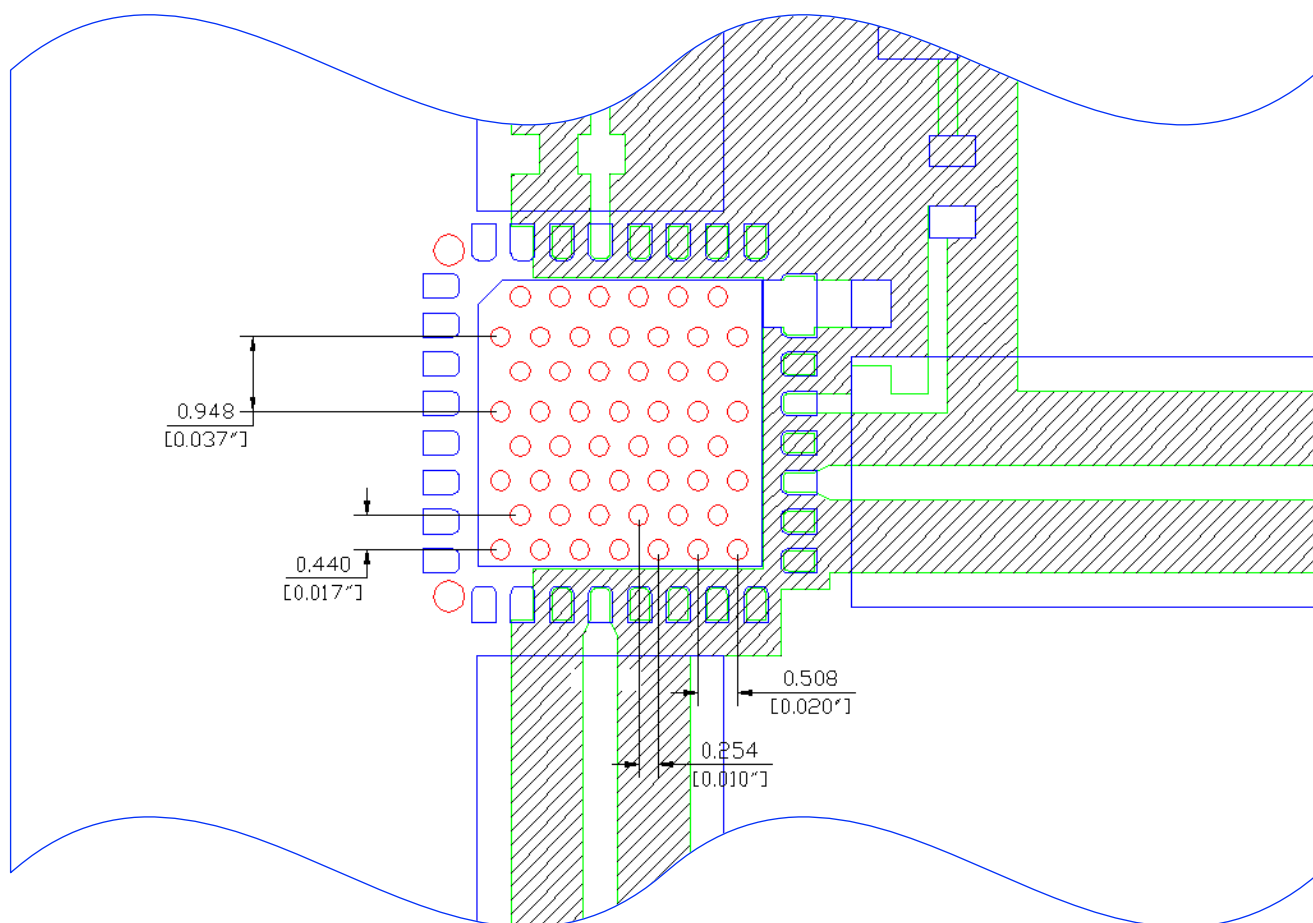

#### Notes:

1. The pad pattern shown has been developed and tested for optimized assembly at TriQuint Semiconductor. The PCB land pattern has been developed to accommodate lead and package tolerances. Since surface mount processes vary from company to company, careful process development is recommended.
2. Ground / thermal vias are critical for the proper performance of this device. Vias have a final plated thru diameter of .25 mm (.010”).



### Product Compliance Information

#### ESD Information



#### Caution! ESD-Sensitive Device

ESD Rating: Class 0  
Value: Passes  $\geq 200V$  min  
Test: Human Body Model (HBM)  
Standard: JEDEC Standard JESD22-A114

#### MSL Rating

Moisture Sensitivity Level (MSL) 3 at 260°C convection reflow per JEDEC standard IPC/JEDEC J-STD-020.

#### Solderability

Compatible with both lead-free (260 °C max. reflow temp.) and tin/lead (245 °C max. reflow temp.) soldering processes.

Package lead plating: matte Sn

#### RoHS Compliance

This part is compliant with EU 2002/95/EC RoHS directive (Restrictions on the Use of Certain Hazardous Substances in Electrical and Electronic Equipment).

This product also has the following attributes:

- Lead Free
- Halogen Free (Chlorine, Bromine)
- Antimony Free
- TBBP-A (C<sub>15</sub>H<sub>12</sub>Br<sub>4</sub>O<sub>2</sub>) Free
- PFOS Free
- SVHC Free

### Recommended Soldering Temperature Profile

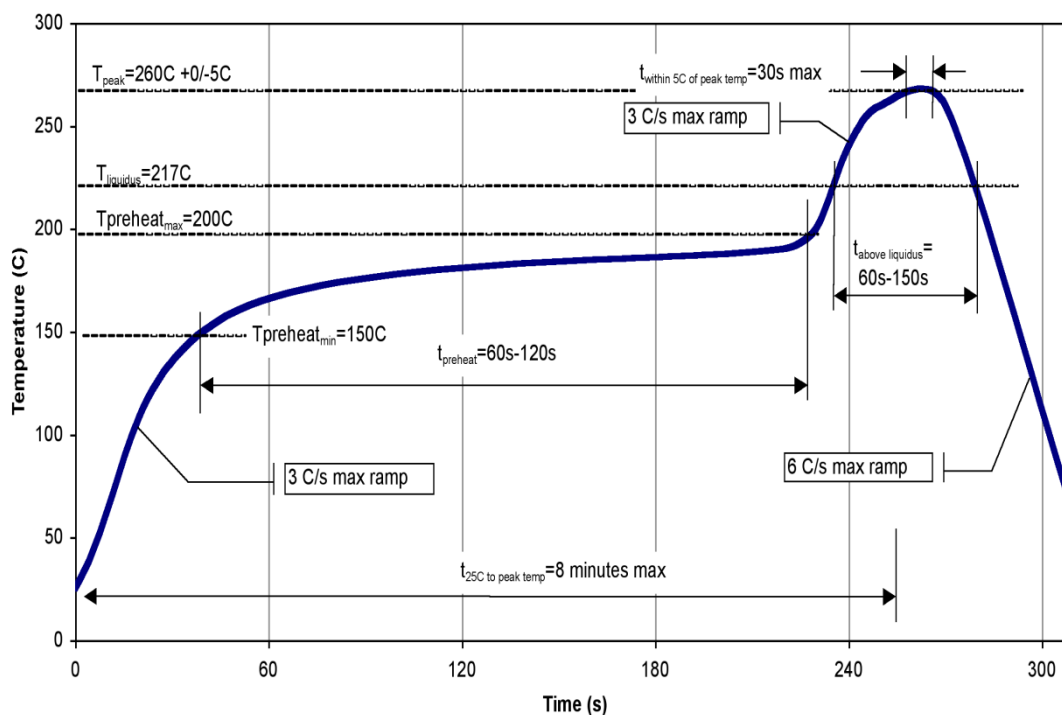

# TGV2529-SM

## 12.5 – 13.5 GHz VCO with Divide by 2



### Contact Information

For the latest specifications, additional product information, worldwide sales and distribution locations, and information about TriQuint:

Web: [www.triquint.com](http://www.triquint.com)      Tel: +1.972.994.8465  
Email: [info-sales@tqs.com](mailto:info-sales@tqs.com)      Fax: +1.972.994.8504

For technical questions and application information:

Email: [info-networks@tqs.com](mailto:info-networks@tqs.com)

### Important Notice

The information contained herein is believed to be reliable. TriQuint makes no warranties regarding the information contained herein. TriQuint assumes no responsibility or liability whatsoever for any of the information contained herein. TriQuint assumes no responsibility or liability whatsoever for the use of the information contained herein. The information contained herein is provided "AS IS, WHERE IS" and with all faults, and the entire risk associated with such information is entirely with the user. All information contained herein is subject to change without notice. Customers should obtain and verify the latest relevant information before placing orders for TriQuint products. The information contained herein or any use of such information does not grant, explicitly or implicitly, to any party any patent rights, licenses, or any other intellectual property rights, whether with regard to such information itself or anything described by such information.

TriQuint products are not warranted or authorized for use as critical components in medical, life-saving, or life-sustaining applications, or other applications where a failure would reasonably be expected to cause severe personal injury or death.