

MACP-010250-C808A0



Coupler 8dB
5 to 1200 MHz

Rev. V1

Features

- Surface Mount
- Typical Coupling 8dB
- 260°C Reflow Compatible
- RoHS* Compliant and lead free
- Available on Tape and Reel.
- Stable over large temperature range.

Description

M/A-COM Tech's MACP-010250-C808A0 is a 8dB broadband Coupler in a low cost, surface mount package. It offers low loss, good Isolation, good input/output matching and exceptional coupling repeatability. Ideally suited for high volume CATV/ Broadband applications.



Schematic

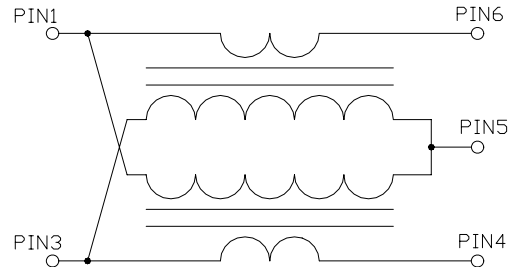

Component Dimensions

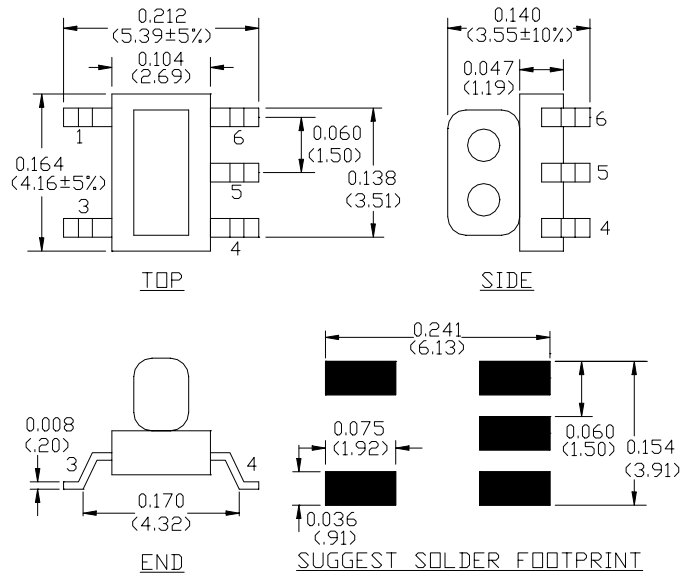

Pin Configuration

Pin no.	Function
1	Output
3	Isolation (External 75 Ohm Load)
4	Coupling
5	Ground
6	Input

Dimensions in inches [mm] Tolerance: .xx ± .02, .xxx ± .010, unless otherwise stated

* Restrictions on Hazardous Substances, European Union Directive 2002/95/EC.

ADVANCED: Data Sheets contain information regarding a product M/A-COM Technology Solutions is considering for development. Performance is based on target specifications, simulated results, and/or prototype measurements. Commitment to develop is not guaranteed.
PRELIMINARY: Data Sheets contain information regarding a product M/A-COM Technology Solutions has under development. Performance is based on engineering tests. Specifications are typical. Mechanical outline has been fixed. Engineering samples and/or test data may be available. Commitment to produce in volume is not guaranteed.

• **North America** Tel: 800.366.2266 • **Europe** Tel: +353.21.244.6400
 • **India** Tel: +91.80.43537383 • **China** Tel: +86.21.2407.1588
 Visit www.macomtech.com for additional data sheets and product information.

M/A-COM Technology Solutions Inc. and its affiliates reserve the right to make changes to the product(s) or information contained herein without notice.

Electrical Specifications: $T_A = 25^\circ\text{C}$, 0dBm, $Z_0 = 75\Omega$, $P_{in} = 0\text{dBm}$

Parameter	Test Conditions	Units	Min	Typ	Max
Coupling (Pin 6 to Pin 4)	5- 1200 MHz	dB	-	8.5	± 0.8
Main Line Loss (Pin 6 to Pin 1)	5 - 500 MHz	dB	-	1.6	1.8
	500 - 1200 MHz	dB	-	1.7	2.3
Return Loss: Input (Pin 6)	5 - 1200MHz	dB	14	19	-
Return Loss: Output (Pin 1)	5 - 1200MHz	dB	18	35	-
Return Loss: Coupling (Pin 4)	5 - 1200MHz	dB	14	18	-
Return Loss: Isolation (Pin 3)	5 -1200MHz	dB	18	32	-
Isolation (Pin 6 to Pin 3)	5 - 250 MHz	dB	25	27	-
	250 - 1200 MHz	dB	18	24	-

Recommended Maximum Ratings

Parameter	Value
Input power	At least +28dBm (631mW)
DC current (tested at 5V)	At least 600mA
Operating Temperature	-40°C to +85°C
Storage Temperature	-55°C to +100°C

Application Circuit

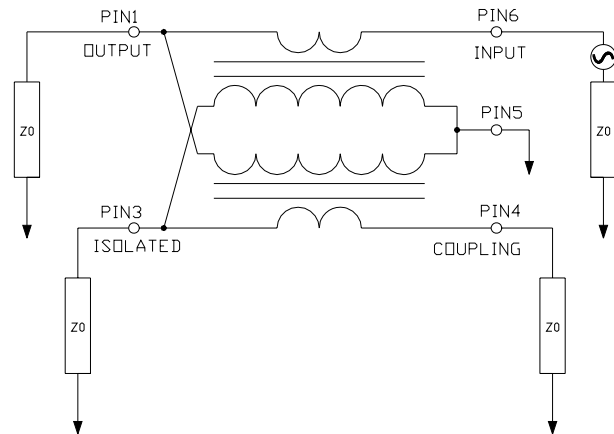

MACP-010250-C808A0



Coupler 8dB
5 to 1200 MHz

Rev. V1

Typical Performance Curves: $T_A = 25^\circ\text{C}$, 0dBm , $Z_0 = 75\Omega$, $P_{in} = 0\text{dBm}$

Coupling (Pin 6 to 4)

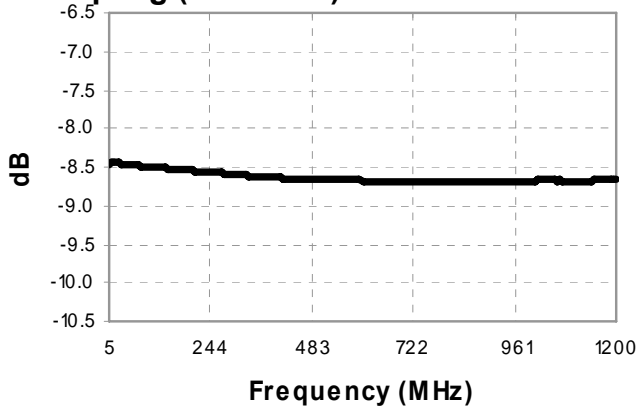

Return Loss: Input (Pin 6)

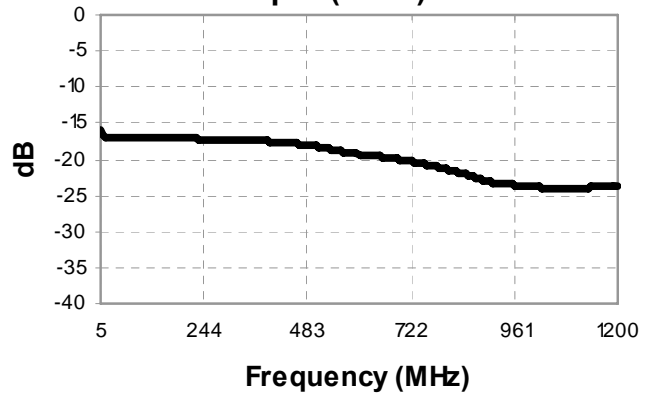

Main Line Loss (Pin 6 to 1)

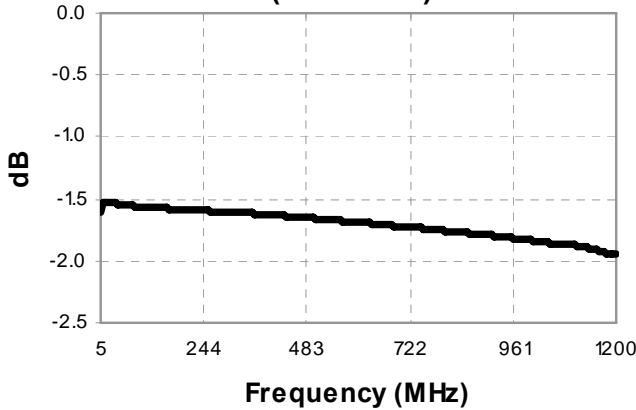

Return Loss: Output (Pin 1)

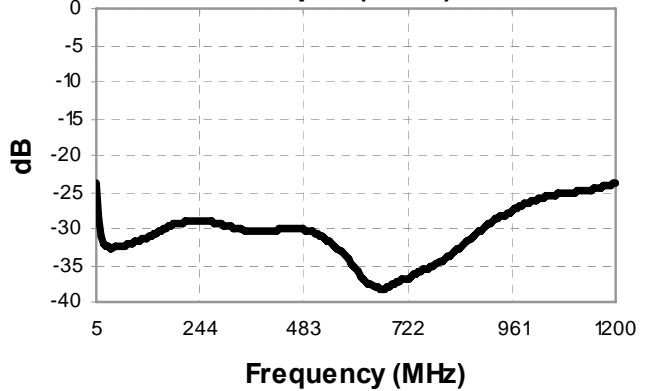

Isolation (Pin6 to 3)

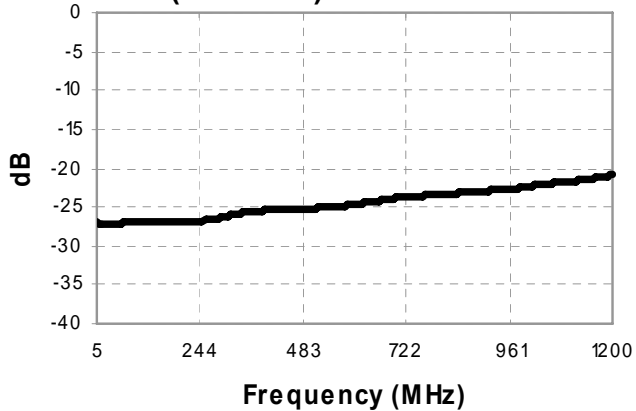

Return Loss: Coupling (Pin4)

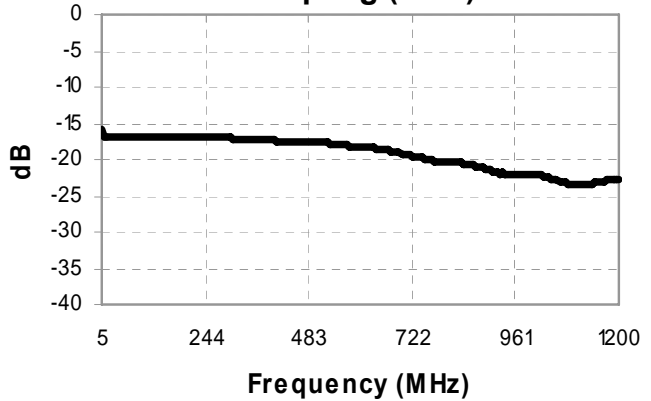

ADVANCED: Data Sheets contain information regarding a product M/A-COM Technology Solutions is considering for development. Performance is based on target specifications, simulated results, and/or prototype measurements. Commitment to develop is not guaranteed.
PRELIMINARY: Data Sheets contain information regarding a product M/A-COM Technology Solutions has under development. Performance is based on engineering tests. Specifications are typical. Mechanical outline has been fixed. Engineering samples and/or test data may be available. Commitment to produce in volume is not guaranteed.

• **North America** Tel: 800.366.2266 • **Europe** Tel: +353.21.244.6400
 • **India** Tel: +91.80.43537383 • **China** Tel: +86.21.2407.1588
 Visit www.macomtech.com for additional data sheets and product information.

M/A-COM Technology Solutions Inc. and its affiliates reserve the right to make changes to the product(s) or information contained herein without notice.

Tape & Reel Information

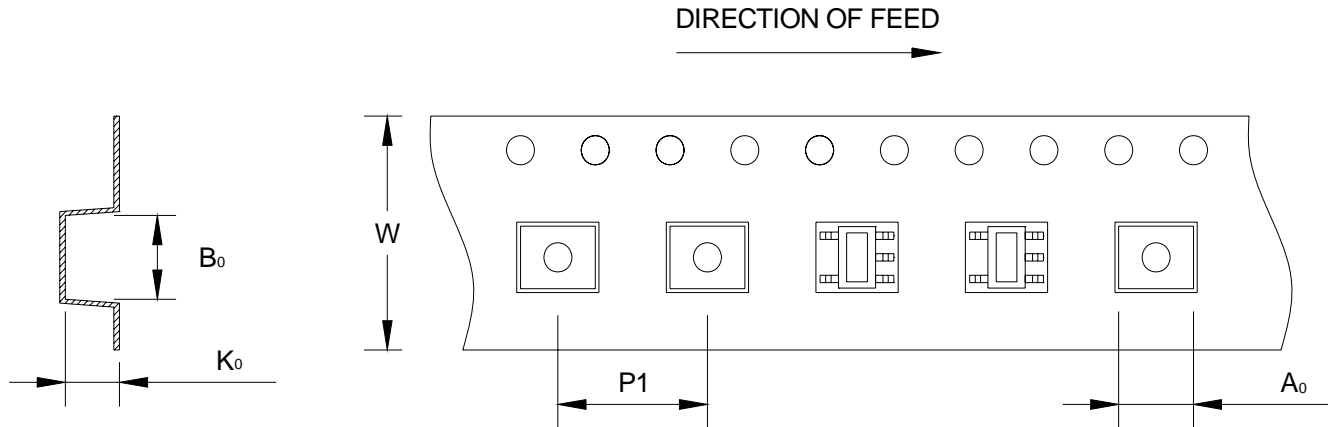

Item	Dimension
Ao	5.9mm +/- 0.1mm
Bo	4.55mm +/- 0.1mm
Ko	3.8mm +/- 0.1mm
W	12.0mm +/- 0.3mm
P1	8.00mm +/- 0.1mm

Ordering Information

Part number	Description
MACP-010250-C808A0	2000 piece reel
MACP-010250-C808TB	Customer Test Board