

## Features

- Attenuation: 2.0 dB steps to 30 dB
- Low DC Power Consumption
- Integral TTL Driver
- 50 Ohm Impedance
- Temperature Stability:  $\pm 0.18$  dB from  $-55^{\circ}\text{C}$  to  $+85^{\circ}\text{C}$  Typ.
- Lead-Free SO-16 Package
- 100% Matte Tin Plating over Copper
- Halogen-Free “Green” Mold Compound
- $260^{\circ}\text{C}$  Reflow Compatible
- RoHS\* Compliant Version of AT65-0233

## Description

M/A-COM's MAATCC0006 is a GaAs FET 4-bit digital attenuator with a 2.0 dB minimum step size and a 30 dB total attenuation range. This device is in a SOIC-16 plastic surface mount package. The MAATCC0006 is ideally suited for use where accuracy, fast speed, very low power consumption and low costs are required. Typical applications include dynamic range setting in precision receiver circuits and other gain/leveling control circuits.

## Ordering Information

Part Number	Package
MAATCC0006	Bulk Packaging
MAATCC0006TR	1000 piece reel
MAATCC0006-TB	Sample Test Board

Note: Reference Application Note M513 for reel size information.

## Schematic with Off-Chip Components or Functional Block Diagram

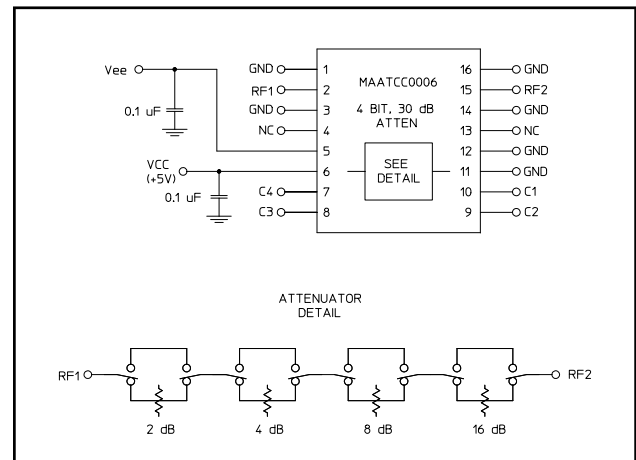

## Pin Configuration

Pin No.	Function	Pin No.	Function
1	GND	9	C2
2	RF1	10	C1
3	GND	11	GND
4	NC <sup>1</sup>	12	GND
5	Vee	13	NC <sup>1</sup>
6	Vcc	14	GND
7	C4	15	RF2
8	C3	16	GND

1. NC = No Connection

\* Restrictions on Hazardous Substances, European Union Directive 2002/95/EC.

## Digital Attenuator 30.0 dB, 4-Bit, TTL Driver, DC-3.0 GHz

Rev. V4

### Electrical Specifications: $T_A = 25^\circ\text{C}$

Parameter	Test Conditions	Frequency	Units	Min	Typ	Max
Insertion Loss	—	DC - 0.5 GHz	dB	—	1.7	2.0
		DC - 2.0 GHz	dB	—	2.3	2.7
		DC - 3.0 GHz	dB	—	2.6	3.1
Attenuation Accuracy	Any Bit or Combination of Bits	DC - 3.0 GHz	dB	$\pm (.4 + 8\% \text{ of attenuation})$	$\pm (.4 + 8\% \text{ of attenuation})$	$\pm (.4 + 8\% \text{ of attenuation})$
VSWR	Full Range	DC - 3.0 GHz	Ratio	—	—	1.7:1
Trise, Tfall Ton, Toff Transients	10% to 90% 50% Cntl to 90%/10% RF In-Band	10% to 90%	nS	—	10	50
		50% Cntl to 90%/10% RF	nS	—	30	150
		In-Band	mV	—	35	—
1 dB Compression	Input Power Input Power	0.05 GHz	dBm	—	+20	—
		0.5 - 3.0 GHz	dBm	—	+28	—
Input IP <sub>3</sub>	Two-tone inputs up to +5 dBm	0.05 GHz	dBm	—	+40	—
		0.5 - 3.0 GHz	dBm	—	+50	—
Input IP <sub>2</sub>	Two-tone inputs up to +5 dBm	0.05 GHz	dBm	—	+45	—
		0.5 - 3.0 GHz	dBm	—	+68	—
V <sub>CC</sub>	—	—	V	4.5	5.0	5.5
V <sub>EE</sub>	—	—	V	-8.0	-5.0	-4.75
V <sub>IL</sub> V <sub>IH</sub>	LOW-level input voltage HIGH-level input voltage	—	V	0.0	—	0.8
		—	V	2.0	—	5.0
I <sub>in</sub> (Input Leakage Current)	V <sub>in</sub> = V <sub>CC</sub> or GND	—	uA	-1.0	—	1.0
I <sub>cc</sub> (Quiescent Supply Current)	V <sub>cntrl</sub> = V <sub>CC</sub> or GND	—	uA	—	250	400
$\Delta I_{cc}$ (Additional Supply Current Per TTL Input Pin)	V <sub>CC</sub> = Max, V <sub>cntrl</sub> = V <sub>CC</sub> - 2.1 V	—	mA	—	—	1.0
I <sub>EE</sub>	V <sub>EE</sub> min to max, V <sub>in</sub> = V <sub>IL</sub> or V <sub>IH</sub>	—	mA	-1.0	-0.2	—

### Absolute Maximum Ratings <sup>2,3</sup>

Parameter	Absolute Maximum
Max. Input Power 0.05 GHz 0.5 - 3.0 GHz	+27 dBm +34 dBm
V <sub>CC</sub>	-0.5V ≤ V <sub>CC</sub> ≤ +7.0V
V <sub>EE</sub>	-8.5V ≤ V <sub>EE</sub> ≤ +0.5V
V <sub>CC</sub> - V <sub>EE</sub>	-0.5V ≤ V <sub>CC</sub> - V <sub>EE</sub> ≤ 14.5V
V <sub>in</sub> <sup>4</sup>	-0.5V ≤ V <sub>in</sub> ≤ V <sub>CC</sub> + 0.5V
Operating Temperature	-40°C to +85°C
Storage Temperature	-65°C to +125°C

- Exceeding any one or combination of these limits may cause permanent damage to this device.
- M/A-COM does not recommend sustained operation near these survivability limits.
- Standard CMOS TTL interface, latch=up will occur if logic signal applied prior to power supply.

2

**ADVANCED:** Data Sheets contain information regarding a product M/A-COM Technology Solutions is considering for development. Performance is based on target specifications, simulated results, and/or prototype measurements. Commitment to develop is not guaranteed.  
**PRELIMINARY:** Data Sheets contain information regarding a product M/A-COM Technology Solutions has under development. Performance is based on engineering tests. Specifications are typical. Mechanical outline has been fixed. Engineering samples and/or test data may be available. Commitment to produce in volume is not guaranteed.

• **North America** Tel: 800.366.2266 • **Europe** Tel: +353.21.244.6400  
 • **India** Tel: +91.80.4155721 • **China** Tel: +86.21.2407.1588  
 Visit [www.macomtech.com](http://www.macomtech.com) for additional data sheets and product information.

M/A-COM Technology Solutions Inc. and its affiliates reserve the right to make changes to the product(s) or information contained herein without notice.

## Handling Procedures

Please observe the following precautions to avoid damage:

## Static Sensitivity

Gallium Arsenide Integrated Circuits are sensitive to electrostatic discharge (ESD) and can be damaged by static electricity. Proper ESD control techniques should be used when handling these devices.

## Truth Table (Digital Attenuator)

C1	C2	C3	C4	Attenuation
0	0	0	0	Loss, Reference
1	0	0	0	2.0 dB
0	1	0	0	4.0 dB
0	0	1	0	8.0 dB
0	0	0	1	16.0 dB
1	1	1	1	30.0 dB

0 = TTL Low; 1 = TTL High

## Typical Performance Curves

### Typical Insertion Loss (dB)

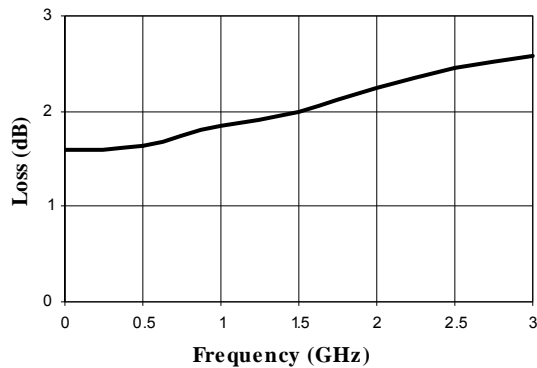

### Attenuation Accuracy, 2 dB

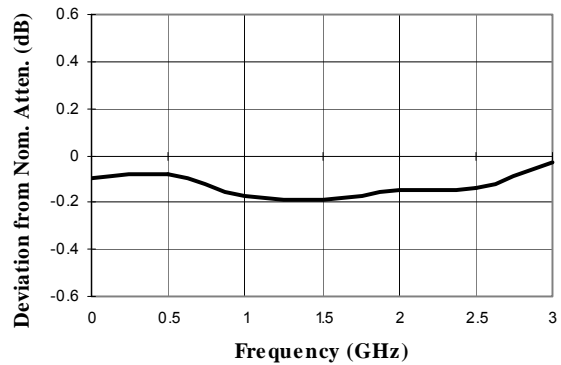

### Attenuation Accuracy, 4 dB

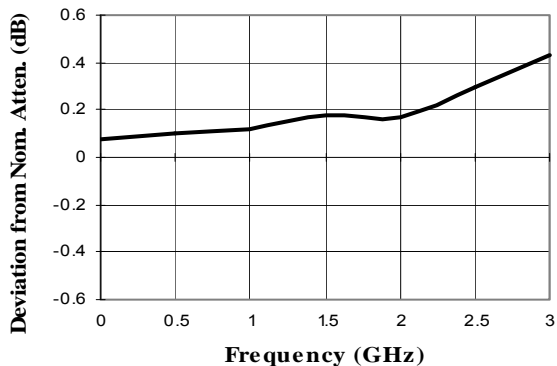

### Attenuation Accuracy, 8 dB

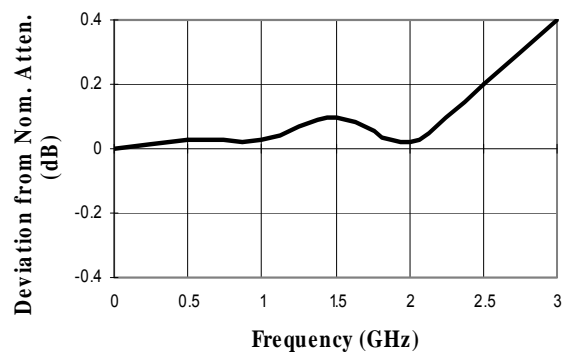

## Typical Performance Curves

Attenuation Accuracy, 16 dB

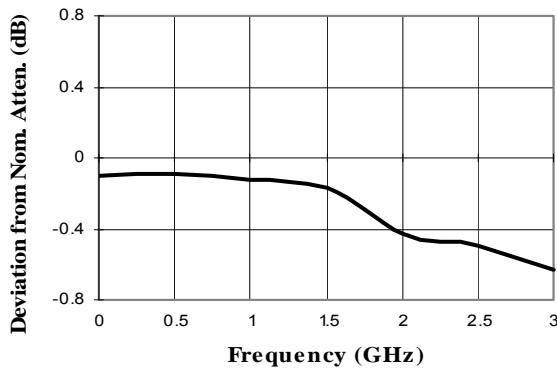

Attenuation Accuracy, 30 dB

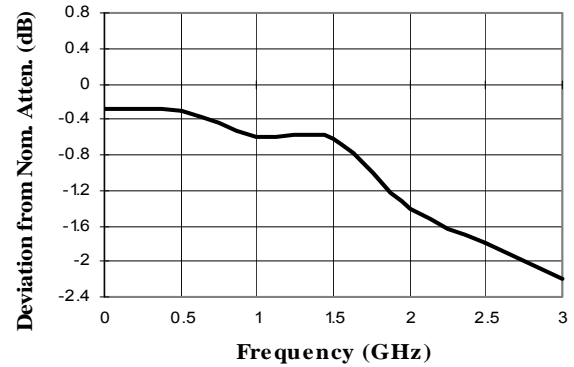

Typical RF1 VSWR

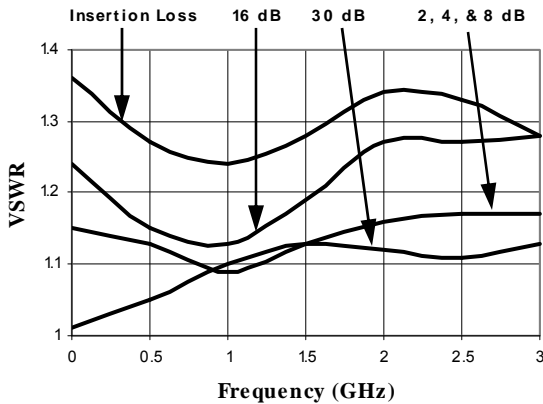

Typical RF2 VSWR

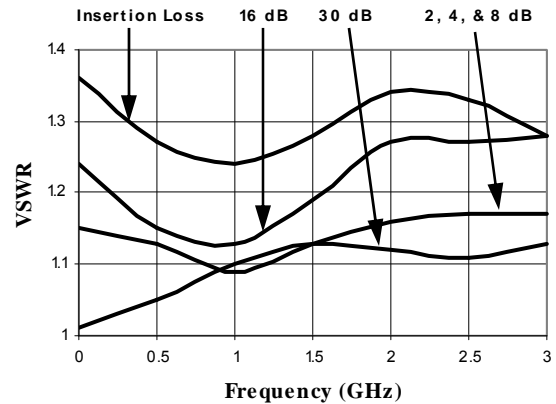

**Lead-Free, SOIC-16<sup>†</sup>**

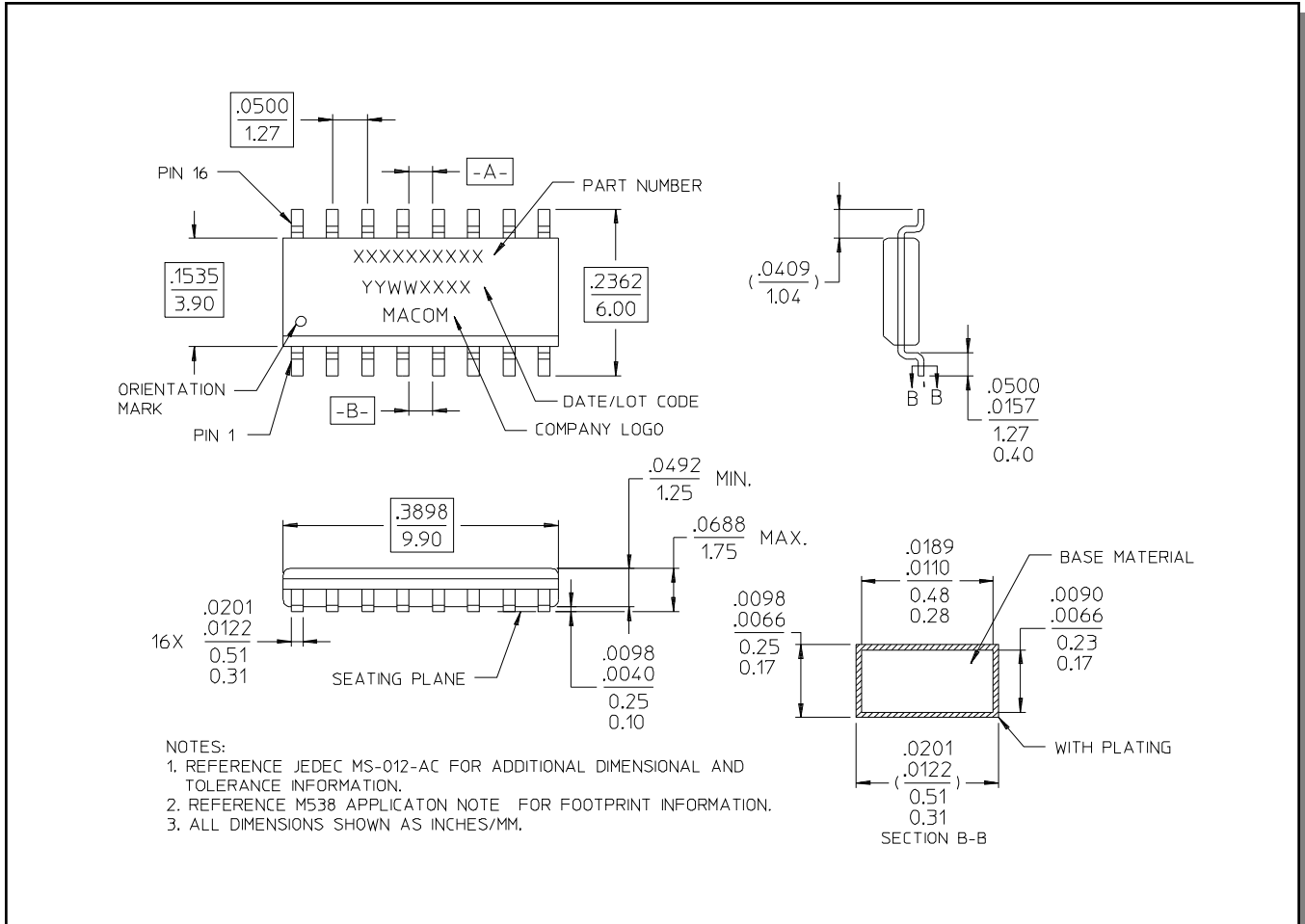

<sup>†</sup> Reference Application Note M538 for lead-free solder reflow recommendations.