

### Applications

- Point-to-Point Radio
- Ka-band Sat-Com

### Product Features

- Frequency Range: 29 – 35 GHz
- Power: 31 dBm Psat, 30 dBm P1dB
- Gain: 18 dB
- TOI: 38 dBm at 20 dBm/tone
- Integrated Power Detector
- Bias:  $V_d = 6\text{ V}$ ,  $I_{dq} = 1100\text{ mA}$ ,  $V_g = -0.55\text{ V}$  Typical
- Package Dimensions: 5.0 x 5.0 x 1.3 mm

### General Description

The TriQuint TGA4537-SM is a Ka-Band Power Amplifier with integrated power detector. The TGA4537-SM operates from 29 – 35 GHz and is designed using TriQuint's power pHEMT production process.

The TGA4537-SM typically provides 31 dBm of saturated output power with small signal gain of 18 dB. Third Order Intercept is 38 dBm at 20 dBm SCL.

The TGA4537-SM is available in a low-cost, surface mount 26 lead 5x5 ACQFN package and is ideally suited for Point-to-Point Radio.

Lead-free and RoHS compliant

Evaluation Boards are available upon request.

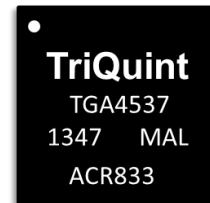

26 lead 5x5mm ACQFN package

### Functional Block Diagram

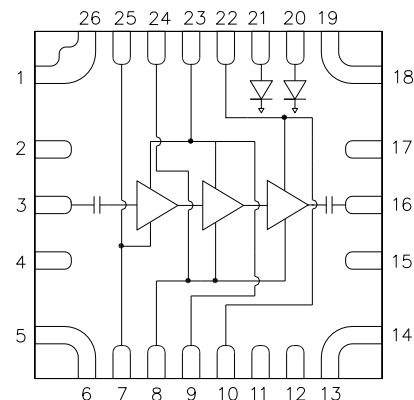

### Pin Configuration

Pin No.	Label
1, 2, 4, 5, 6, 12, 13, 14, 15, 17, 18, 19, 26	GND
3	RF IN
7, 25	VG1
8, 24	VG23
9, 23	VD12
10, 22	VD3
11	NC
16	RFOUT
20	VDET
21	VREF

### Ordering Information

Part No.	ECCN	Description
TGA4537-SM	3A001.b.2.d	Ka-Band Power Amplifier
Standard T/R size = 200 pieces on a 7" reel		

### Absolute Maximum Ratings

Parameter	Rating
Drain Voltage, Vd	6.5 V
Gate Voltage, Vg	-3.5 to 0 V
Drain to Gate Voltage, Vd – Vg	10 V
Drain Current, Id	2.5 A
Gate Current, Ig	-7 to +52 mA
Power Dissipation, Pdiss	16.2 W
RF Input Power, CW, T = 25 °C	25 dBm
Channel Temperature, Tch	200 °C
Mounting Temperature (30 sec)	260 °C
Storage Temperature	-40 to 150 °C

Operation of this device outside the parameter ranges given above may cause permanent damage.

### Recommended Operating

Parameter	Min	Typ	Max	Units
Operating Temp. Range	-40		+85	°C
Vd		6.0		V
Idq		1100		mA
Id_drive		1750		mA
Vg		-0.55		V
Ig_drive (Under RF Drive)		15		mA

Electrical specifications are measured at specified test conditions. Specifications are not guaranteed over all recommended operating conditions.

### Electrical Specifications

Test conditions unless otherwise noted: Vd = +6 V, Idq = 1100 mA, Vg = -0.55 V, Temp = +25°C, Z<sub>0</sub> = 50 Ω

Parameter	Conditions	Min	Typ	Max	Units
Operational Frequency Range		29		35	GHz
Gain			18		dB
Input Return Loss			6		dB
Output Return Loss			8		dB
Output Power @ Saturation			31		dBm
Output Power @ 1 dB Gain Compression			30		dBm
Output TOI @ 20 dBm/Tone Pout/tone			38		dBm
Gain Temperature Coefficient			-0.03		dB/°C
Power Temperature Coefficient			-0.01		dBm/°C

**Specifications**

**Thermal and Reliability Information**

Parameter	Conditions	Rating
Thermal Resistance, $\theta_{JC}$ , measured to back of package	Tbase = 85 °C	$\theta_{JC} = 10 \text{ }^\circ\text{C/W}$
Channel Temperature (Tch), and Median Lifetime (Tm)	Tbase = 85 °C Vd = 6 V Id = 1100 mA Pdis = 6.6 W	Tch = 151 °C Tm = 9.3E+5 Hours

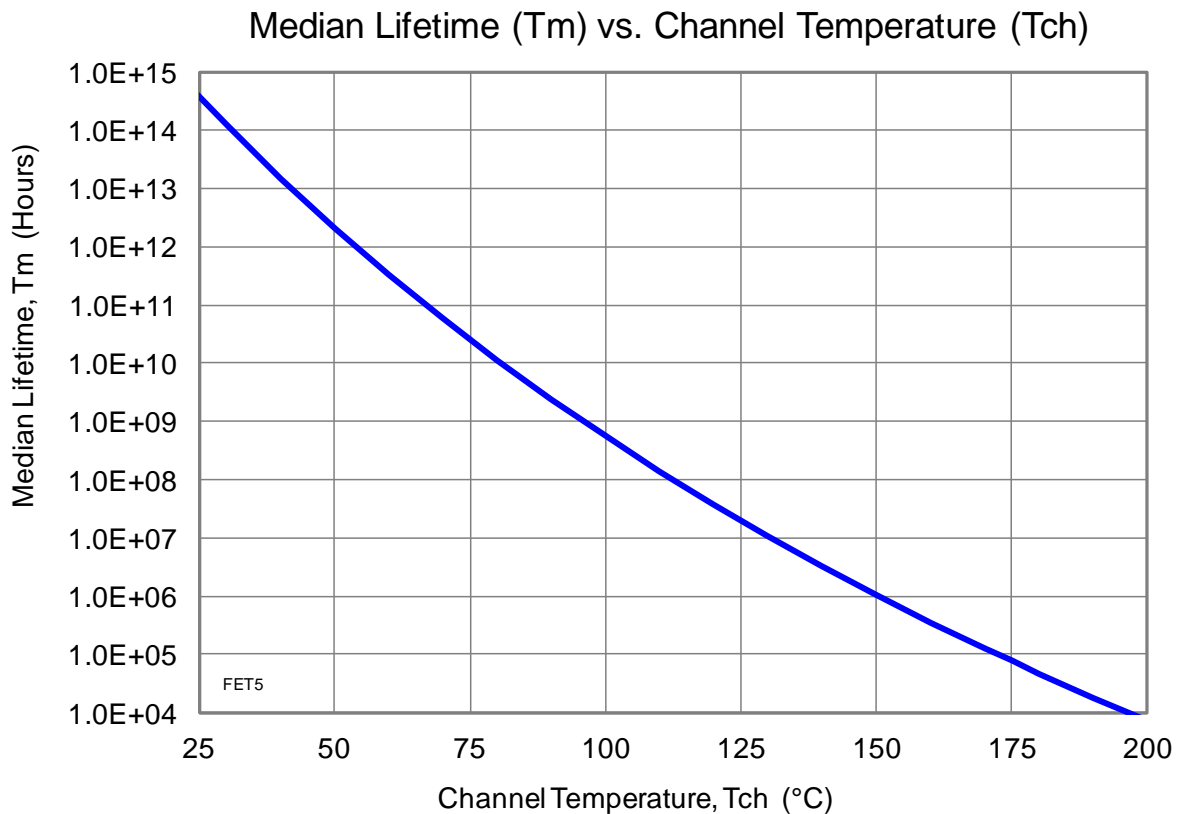

### Typical Performance

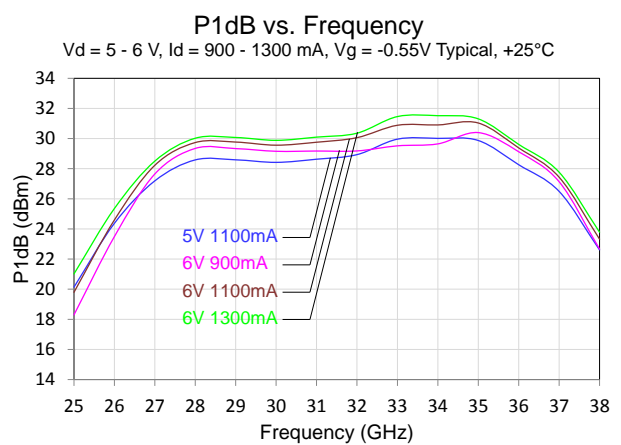
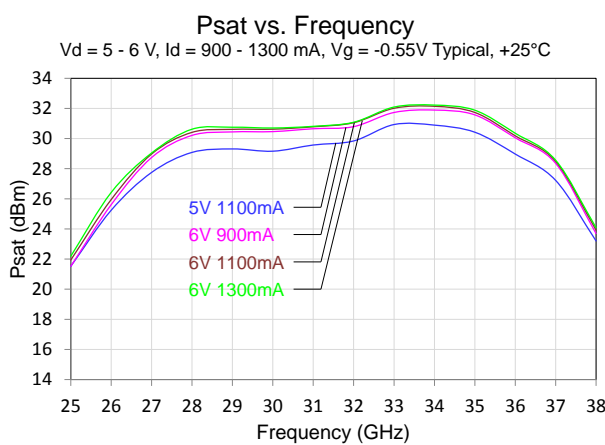
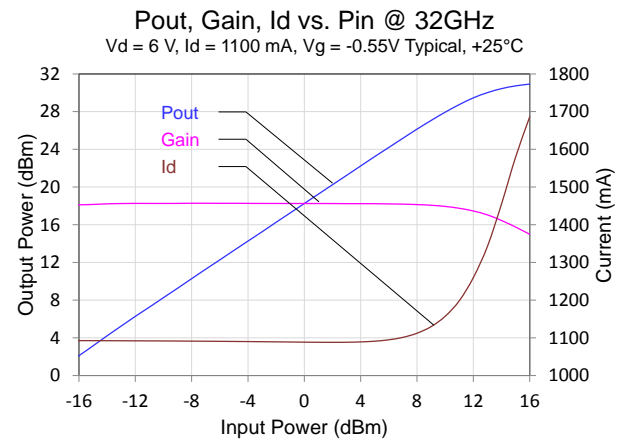
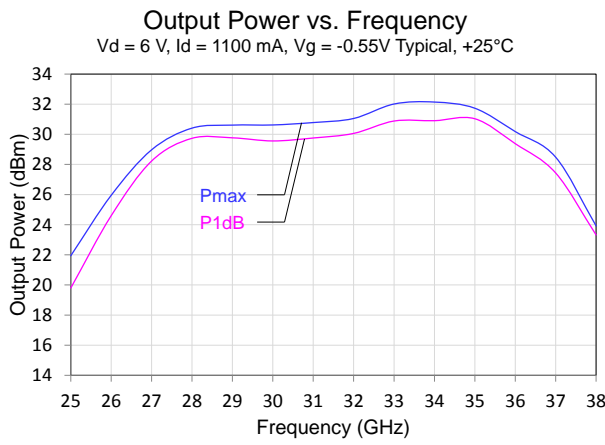
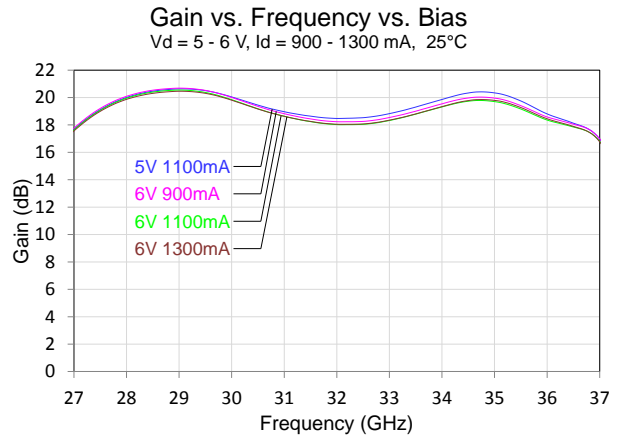
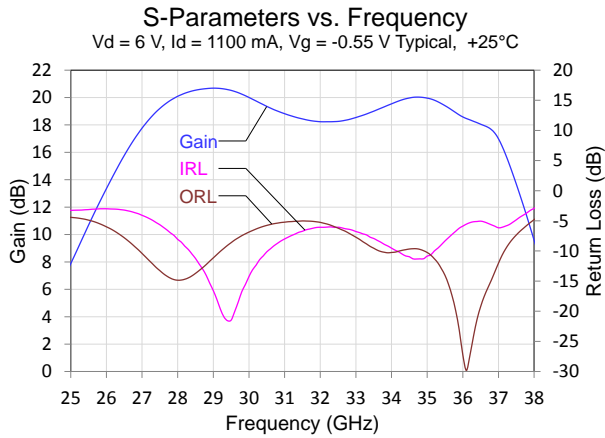

### Typical Performance

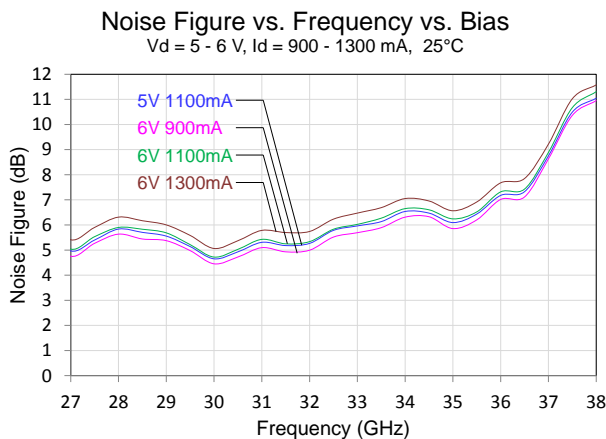
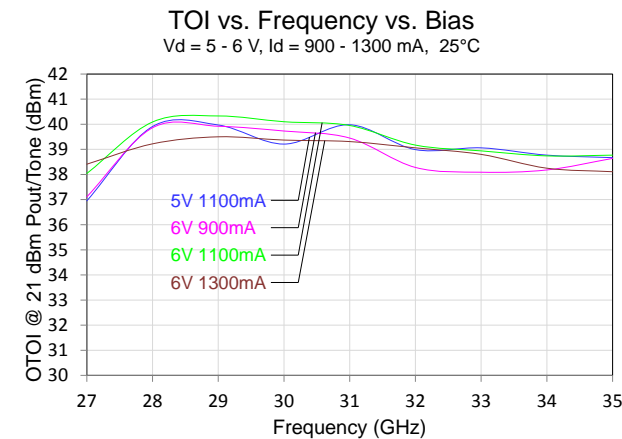
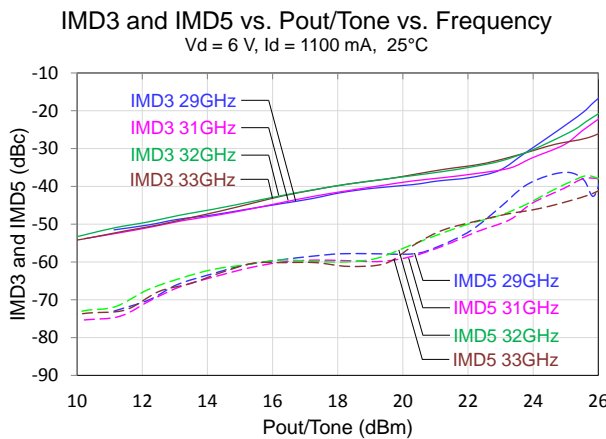
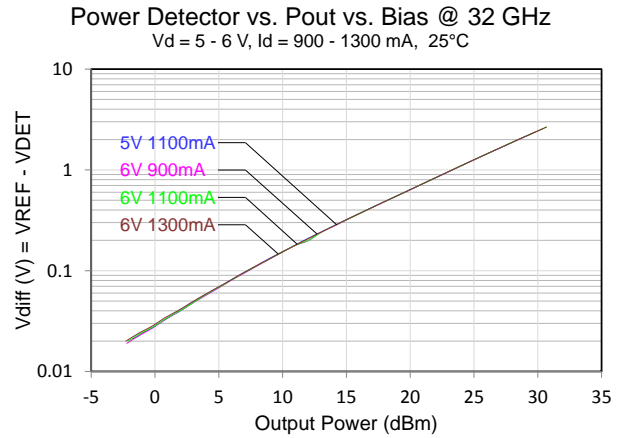
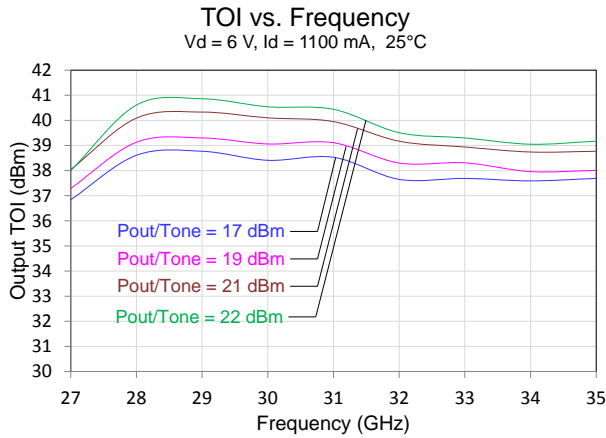

**Typical Performance**

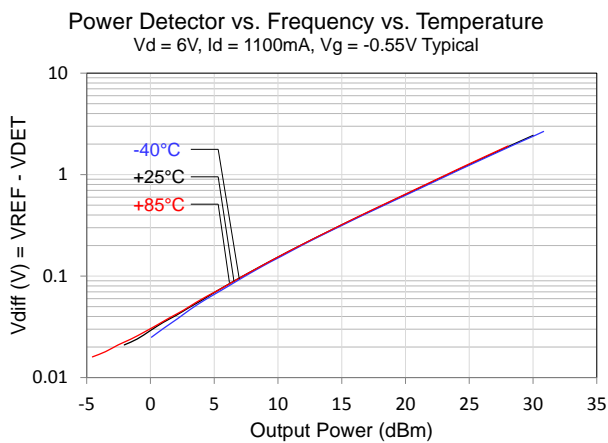
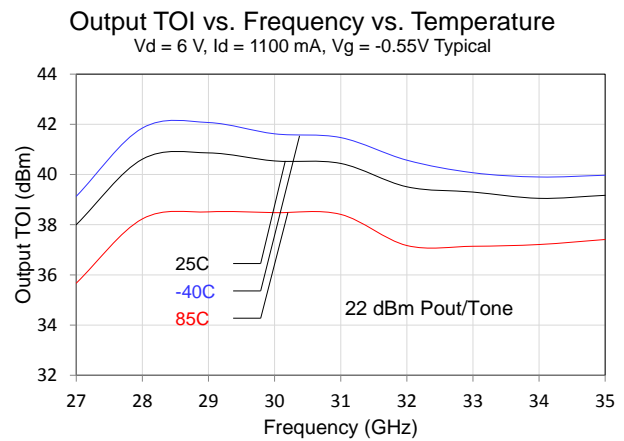
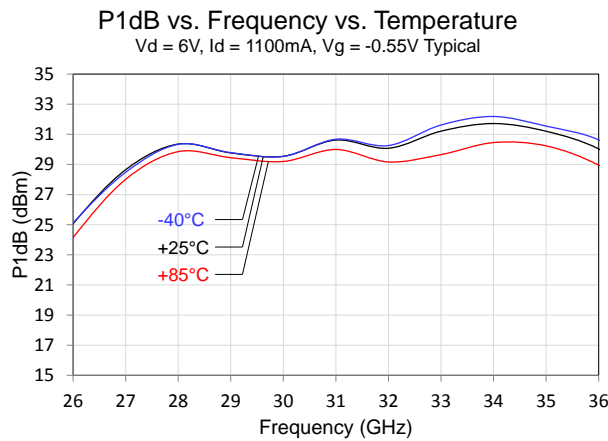
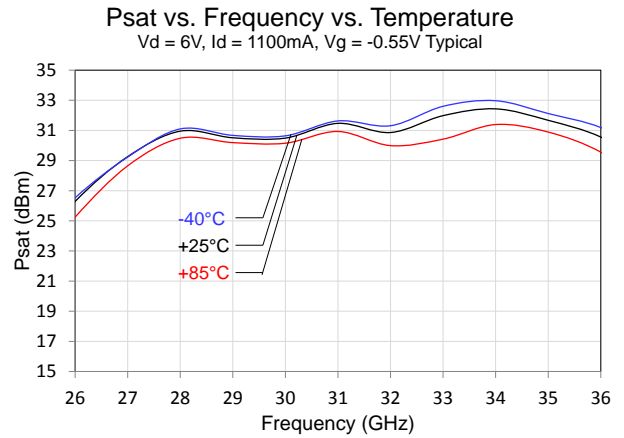
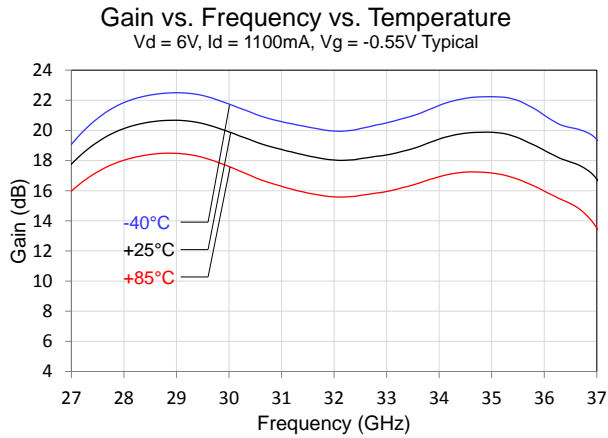

## Pin Configuration and Description

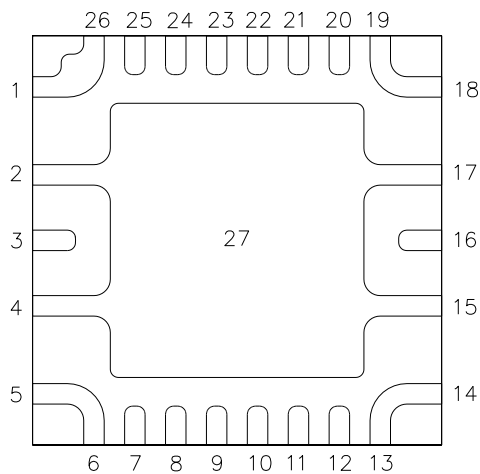

Pin No.	Label	Description
1, 5, 6, 13 14, 18, 19, 26	GND	Must be connected to Ground
2, 4, 15, 17, 27	GND	Backside paddle. Multiple vias should be employed to minimize inductance and thermal resistance; see 'PCB Mounting Pattern' on page 11 for suggested footprint
3	RF IN	RF input, matched to 50 ohms
7, 25	VG1	Stage 1 gate voltage <sup>(1)</sup>
8, 24	VG23	Stage 2 and 3 gate voltage <sup>(1)</sup>
9, 23	VD12	Stage 1 and 2 drain voltage <sup>(1)</sup>
10, 22	VD3	Stage 3 drain voltage <sup>(1)</sup>
11	NC	No internal connection; Can be grounded on PCB or left open
12	GND	Internally connected to GND. Can be grounded on the PCB or left open
16	RF OUT	RF output, matched to 50 ohms
20	VDET	Detector diode output voltage. Varies with RF output power
21	VREF	Reference diode output voltage

(1) Bias bypass network is required; see 'Application Circuit' on page 8 as an example.

### Application Circuit

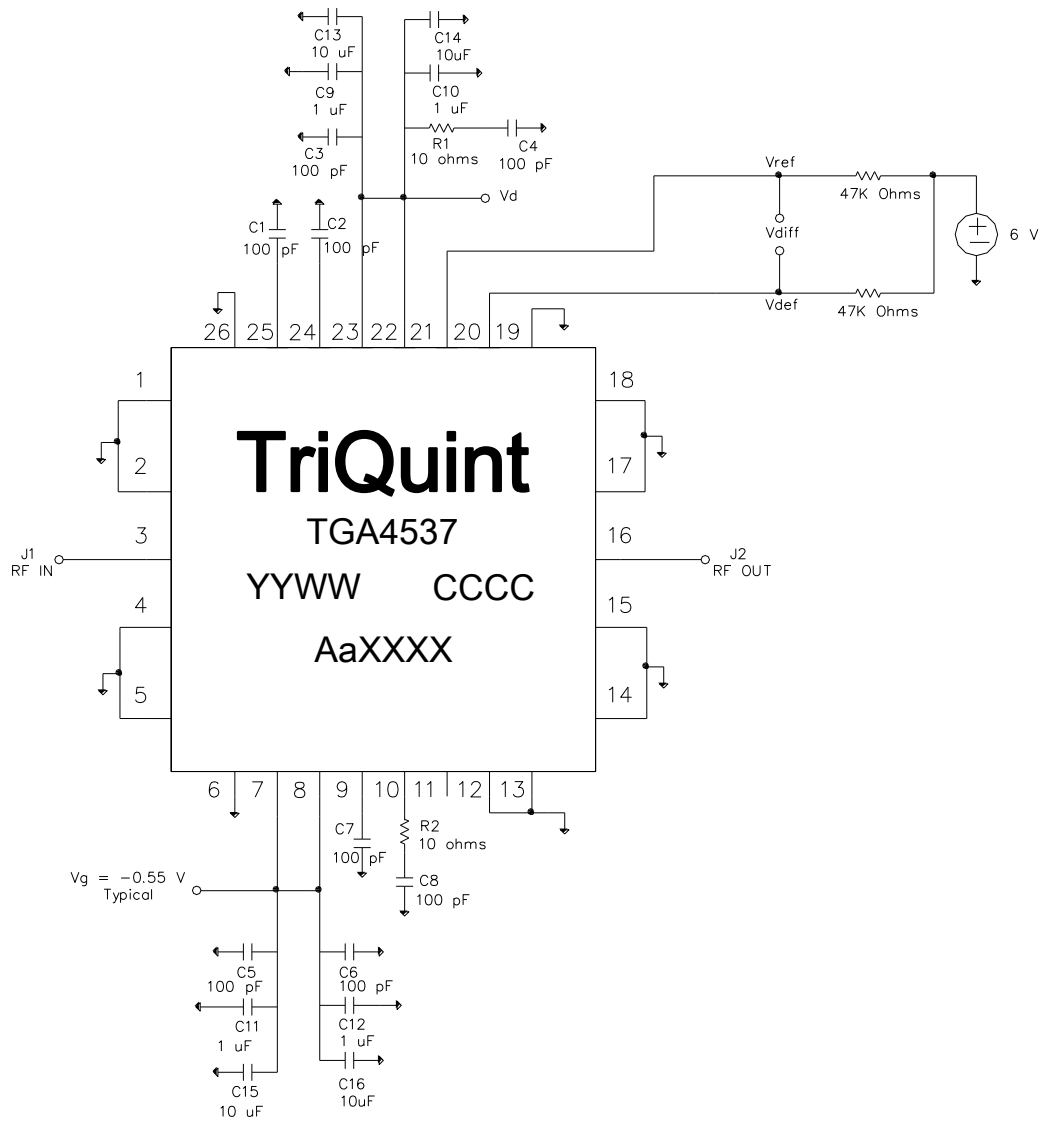

Note A: R1 and R2 are required for Stability

Bias-up Procedure	Bias-down Procedure
Vg set to -1.5 V	Turn off RF supply
Vd set to +6 V	Reduce Vg to -1.5 V. Ensure Id ~ 0 mA
Adjust Vg more positive until quiescent Id is 1100 mA. This will be ~ Vg = -0.55 V typical	Turn Vd to 0 V
Apply RF signal to RF Input	Turn Vg to 0 V



## Application Circuit

### PC Board Layout

Board material is Rogers Corp. 4003 0.008" thickness with 1/2 oz copper cladding. For further technical information, refer to the [TGA4537-SM](#) Product Information page.

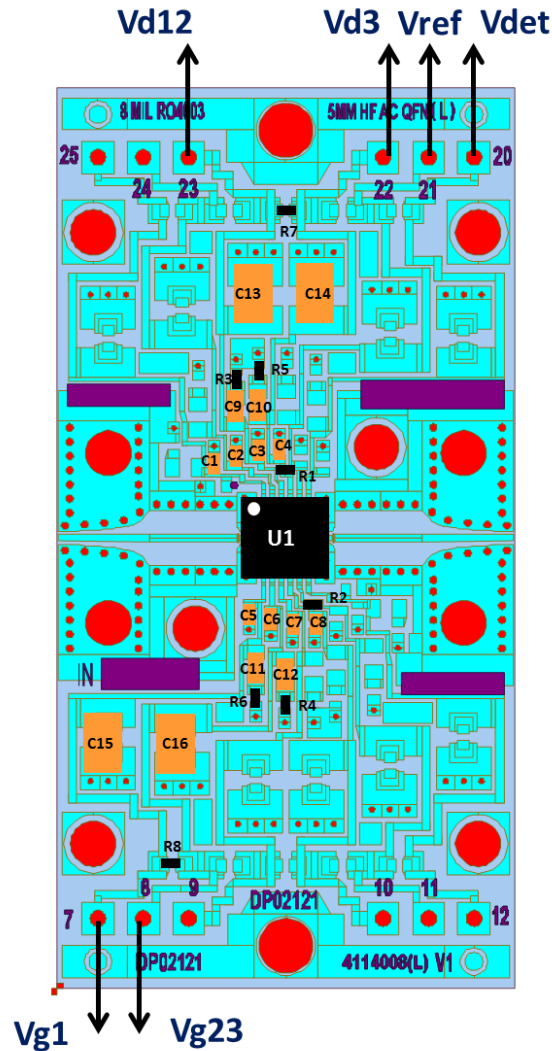

### Bill of Material

Ref Des	Value	Description	Manufacturer	Part Number
U1		Ka Band Power Amplifier	TriQuint	TGA4537-SM
C1 thru C8	100.0 pF	Cap, 0402, 20V, 5%, COG	various	
C9 thru C12	1.0 $\mu$ F	Cap, 0603/0805, 25V, 5%, COG	various	
C13 thru C16	10.0 $\mu$ F	Cap, 0805, 25V, COG	various	
R1, R2	10 $\Omega$	Res, 0402, 1/16 W, 5%, SMD	various	
R3 thru R8	0 $\Omega$	Res. 0402, 1/16 W, 5% SMD	various	

**Mechanical Information**

**Package Marking and Dimensions**

All dimensions are in millimeters.

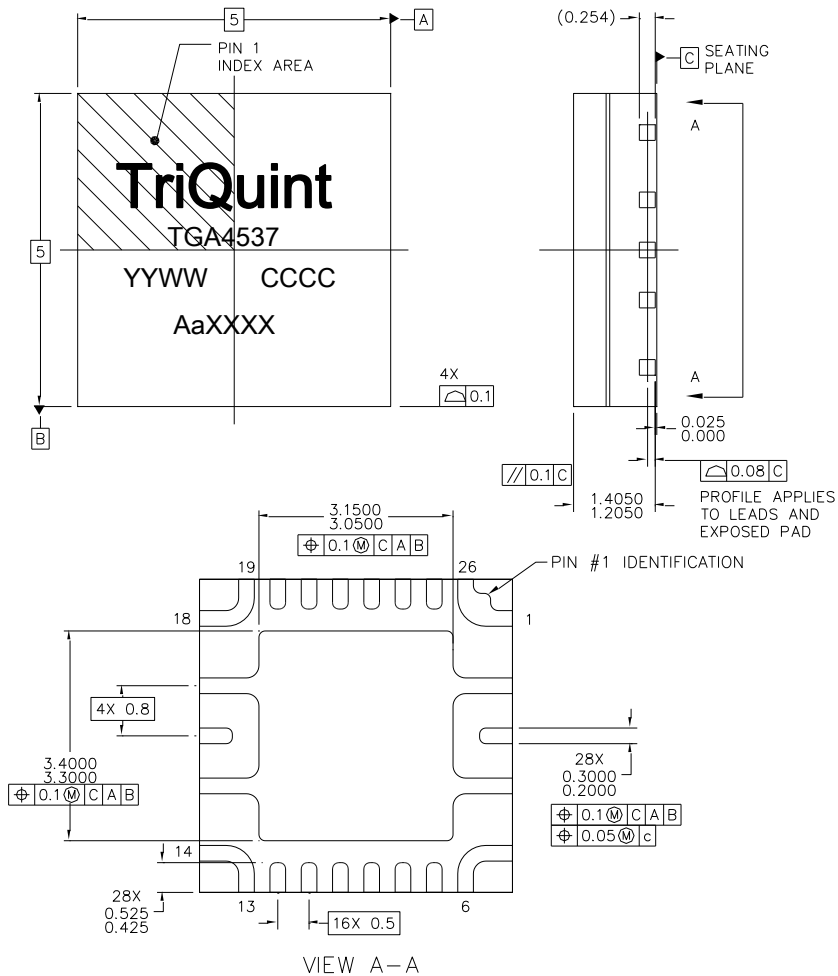

The TGA4537-SM will be marked with the “YYWW” designator and a lot code marked below the part designator. The “YY” represents the last two digits of the year the part was manufactured, the “WW” is the work week, the “CCCC” is the country code, the “Aa” is the vendor, and the “XXXX” is the last 4 digit of lot number.

This package is lead-free/RoHS-compliant with a copper alloy base (CDA194), and the plating material on the leads is NiPdAu. It is compatible with lead-free (maximum 260 °C reflow temperature) soldering process.

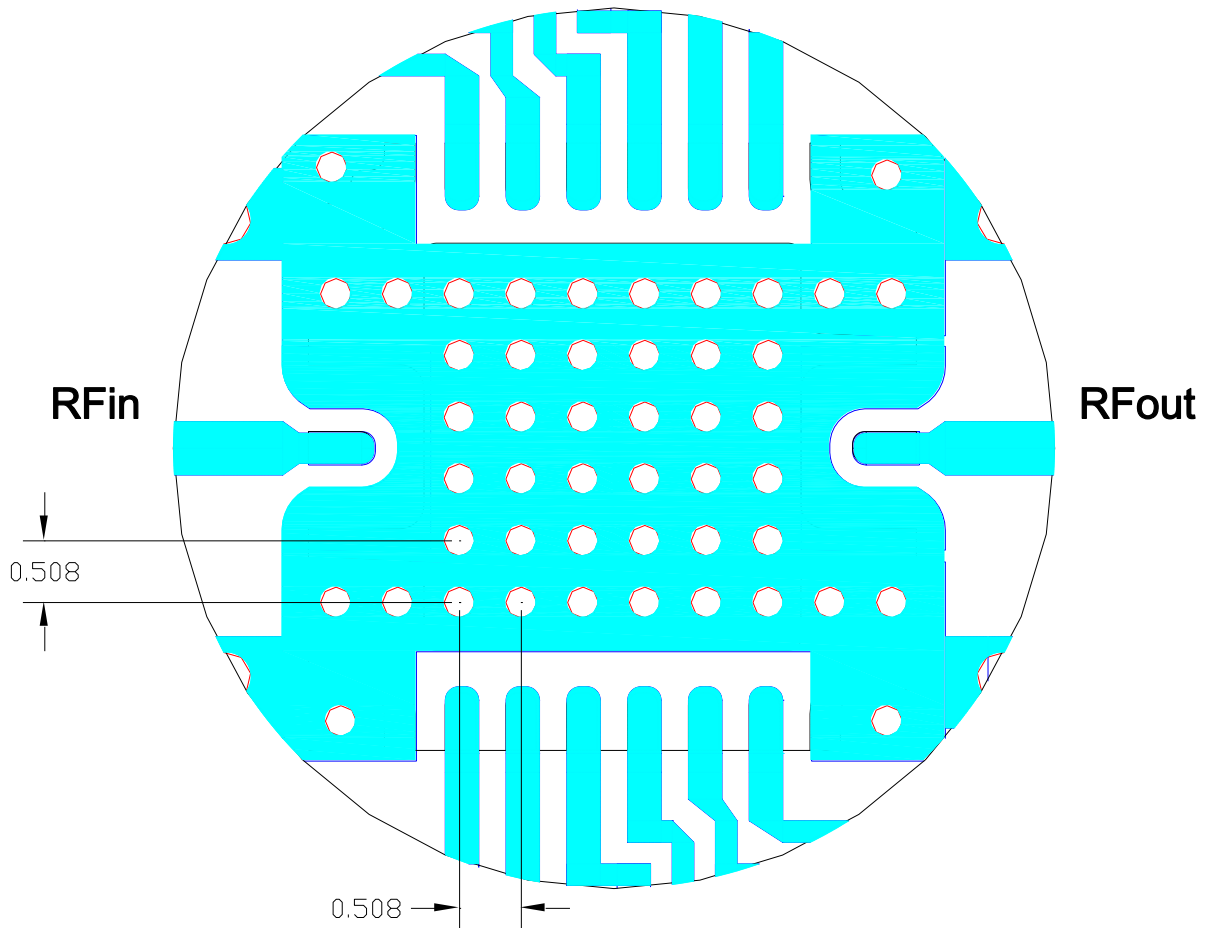
**Mechanical Information****PCB Mounting Pattern****Notes:**

1. The pad pattern shown has been developed and tested for optimized assembly at TriQuint Semiconductor. The PCB land pattern has been developed to accommodate lead and package tolerances. Since surface mount processes vary from company to company, careful process development is recommended.
2. Ground vias are critical for the proper performance of this device. Vias have a final plated thru diameter of .25 mm (.010").

**Tape and Reel Information**

Standard T/R size = 200 pieces on a 7" reel

Vendor: Tek-Pak P/N QFN0500x0500F-L500

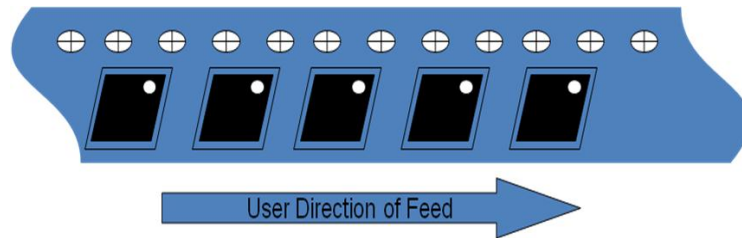

**CARRIER AND COVER TAPE DIMENSIONS**

Part	Feature	Symbol	Size (in)	Size (mm)
Cavity	Length	A0	0.209	5.3
	Width	B0	0.209	5.3
	Depth	K0	0.064	1.65
	Pitch	P1	0.315	8.00
Cover Tape	Width	C	0.362	9.2
Carrier Tape	Width	W	0.472	12.00

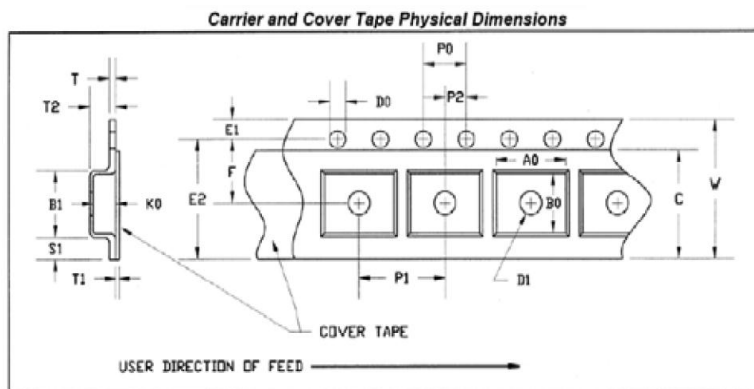

**Product Compliance Information**

**ESD Sensitivity Ratings**



Caution! ESD-Sensitive Device

ESD Rating: Class 1A  
 Value: Passed  $\geq 300$  V min.  
 Test: Human Body Model (HBM)  
 Standard: JEDEC Standard JESD22-A114

**MSL Rating**

MSL Rating: Level 3  
 Test: 260°C convection reflow  
 Standard: JEDEC Standard IPC/JEDEC J-STD-020

**Solderability**

Compatible with lead-free (260°C maximum reflow temperature).

Package lead plating: NiPdAu.

The use of no-clean solder to avoid washing after soldering is recommended.

This package is not compatible with solder containing lead.

**RoHs Compliance**

This part is compliant with EU 2002/95/EC RoHS directive (Restrictions on the Use of Certain Hazardous Substances in Electrical and Electronic Equipment).

This product also has the following attributes:

- Lead Free
- Halogen Free (Chlorine, Bromine)
- Antimony Free
- TBBP-A (C<sub>15</sub>H<sub>12</sub>Br<sub>4</sub>O<sub>2</sub>) Free
- PFOS Free
- SVHC Free

**Recommended Solder Temperature Profile**

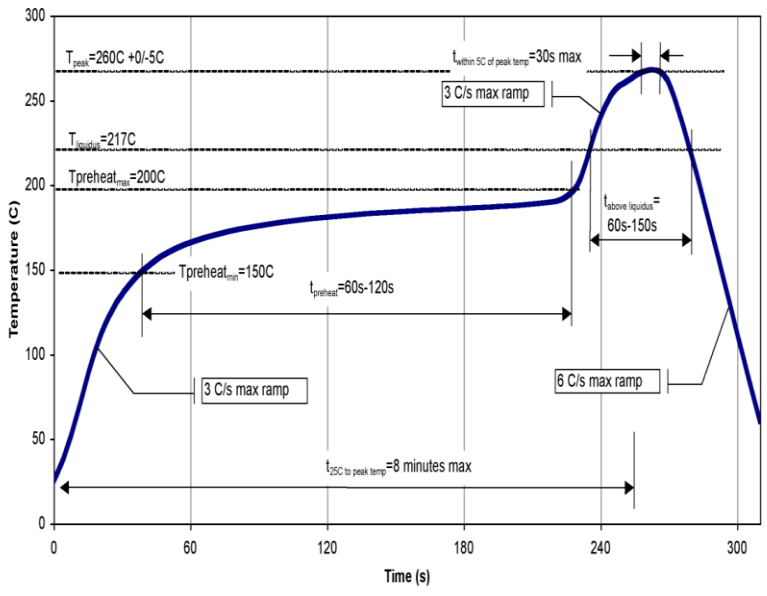

## Contact Information

For the latest specifications, additional product information, worldwide sales and distribution locations, and information about TriQuint:

**Web:** [www.triquint.com](http://www.triquint.com)  
**Email:** [info-sales@triquint.com](mailto:info-sales@triquint.com)

**Tel:** +1.972.994.8465  
**Fax:** +1.972.994.8504

For technical questions and application information: **Email:** [info-networks@triquint.com](mailto:info-networks@triquint.com)

## Important Notice

The information contained herein is believed to be reliable. TriQuint makes no warranties regarding the information contained herein. TriQuint assumes no responsibility or liability whatsoever for any of the information contained herein. TriQuint assumes no responsibility or liability whatsoever for the use of the information contained herein. The information contained herein is provided "AS IS, WHERE IS" and with all faults, and the entire risk associated with such information is entirely with the user. All information contained herein is subject to change without notice. Customers should obtain and verify the latest relevant information before placing orders for TriQuint products. The information contained herein or any use of such information does not grant, explicitly or implicitly, to any party any patent rights, licenses, or any other intellectual property rights, whether with regard to such information itself or anything described by such information.

TriQuint products are not warranted or authorized for use as critical components in medical, life-saving, or life-sustaining applications, or other applications where a failure would reasonably be expected to cause severe personal injury or death.