

### Applications

- Commercial and Military Radar
- Communications
- Electronic Warfare
- Instrumentation
- General Purpose High Power Switching

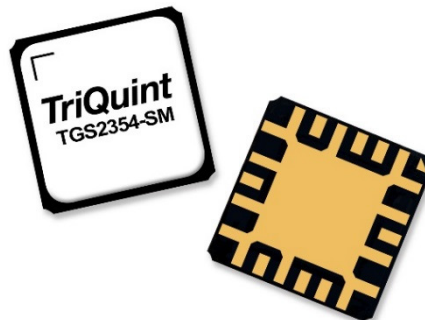

### Product Features

- Frequency Range: 0.5 - 6 GHz
- Insertion Loss: < 1.1 dB
- Power Handling: 46 dBm (P.1dB)
- Isolation: > 25 dB typical
- Return Loss: > 15 dB
- Control Voltages: 0 V/-40 V
- Switching Speed: < 50 ns
- Reflective Switch
- Package Dimensions: 4.0 x 4.0 x 1.42 mm

### Functional Block Diagram

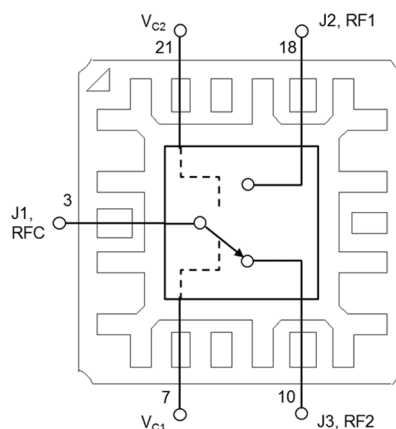

### General Description

The TriQuint TGS2354-SM is a Single-Pole, Double-Throw (SPDT) reflective switch fabricated on TriQuint's TQGaN25 0.25um GaN on SiC production process.

Operating from 0.5 to 6GHz, the TGS2354-SM typically supports up to 40W input power handling at control voltages of 0/-40 V. This switch maintains low insertion loss of 1.1 dB or less and greater than 25dB isolation, making it ideal for high power switching applications across both defense and commercial platforms.

The TGS2354-SM is available in a 4x4 mm air-cavity QFN package comprised of an aluminum-nitride base with a LCP epoxy-sealed lid. This, along with the minimal DC power consumption, allows for easy system integration.

Lead-free and RoHS compliant.

Evaluation boards available on request.

### Pin Configuration

Pin No.	Label
3	RFC
7	V <sub>C1</sub>
21	V <sub>C2</sub>
18	RF1
10	RF2
1-2, 4-6, 8-9, 11-17, 19-20, 22-23	GND

### Ordering Information

Part No.	ECCN	Description
TGS2354-SM	EAR99	0.5-6 GHz 40 Watt GaN Switch

### Absolute Maximum Ratings

Parameter	Rating
Control Voltage (V <sub>c</sub> )	-50 V
Control Current (I <sub>c</sub> )	-1.0 / +1.0 mA
Power Dissipation (CW)	15 W
RF Input Power (CW)	46.5 dBm
Channel Temperature, T <sub>CH</sub>	275 °C
Mounting Temperature (30 sec)	320 °C
Storage Temperature	-55 to 150 °C

Operation of this device outside the parameter ranges given above may cause permanent damage.

### Recommended Operating Conditions

Parameter	Min	Typ	Max	Units
Frequency	0.5		6	GHz
Input Power Handling (CW)		46		dBm
Control Voltage		-40		V
Channel Temp., T <sub>ch</sub>		≤ 225		°C

Electrical specifications are measured at specified test conditions. Specifications are not guaranteed over all recommended operating conditions.

### Electrical Specifications

Test conditions unless otherwise noted: Temp = +25 °C. Z<sub>0</sub> = 50 Ω, V<sub>c</sub> = -40 V, , parts mounted to EVB (page 8)

Parameter	Min	Typ	Max	Units
Operational Frequency Range	0.5		6	GHz
P-0.1dB (CW)		44		dBm
Control Current (I <sub>c</sub> )		0.1		mA
Insertion Loss (On-State), 0.5-4 GHz		< 0.7		dB
Insertion Loss (On-State), 4-6 GHz		< 1.1		dB
Input Return Loss – On-State (Common Port RL)		> 15		dB
Output Return Loss – On-State (Switched Port RL)		> 15		dB
Isolation (Off-State)		> 25		dB
Output Return Loss – Off-State (Isolated Port RL)		> 2		dB
Control Voltage		-40	-48	V
Switching Speed (10-90% and 90-10%, V <sub>c</sub> =-20V)		< 50		ns
Insertion Loss Temperature Coefficient		0.004		dB/ °C

### Specifications

#### Thermal and Reliability Information

Parameter	Conditions	Value	Units
Thermal Resistance ( $\theta_{JC}$ ) <sup>(1)</sup>	$T_{BASE} = 85\text{ }^{\circ}\text{C}$ , $V_{C1} = 0\text{ V}$ , $V_{C2} = -40\text{ V}$ , $P_{IN} = 40\text{ W}$ , $P_{DISS} = 12\text{ W}$	7.00	$^{\circ}\text{C/W}$
Channel Temperature ( $T_{CH}$ ) <sup>(1)</sup>		169	$^{\circ}\text{C}$
Median Lifetime ( $T_M$ )		2.38E08	Hrs

Notes:

- MMIC attached to 12 mil AlN QFN base using 0.8 mil thick Diemat 6030 epoxy. Thermal resistance is determined from the channel to the back of the package (fixed 85  $^{\circ}\text{C}$  temperature).

### Median Lifetime

Test Conditions: 40 V; Failure Criteria = 10% reduction in  $I_{D\text{ MAX}}$

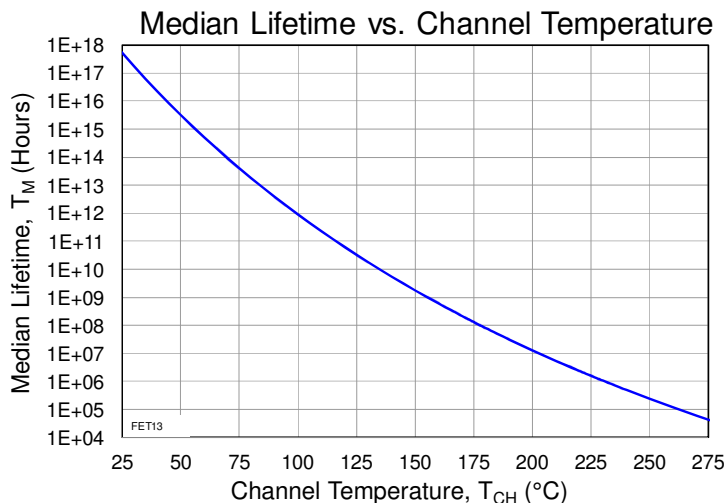

### Typical Performance

Test conditions unless otherwise noted: CW RF Input, Temp= +25 °C, parts mounted to EVB (page 8)

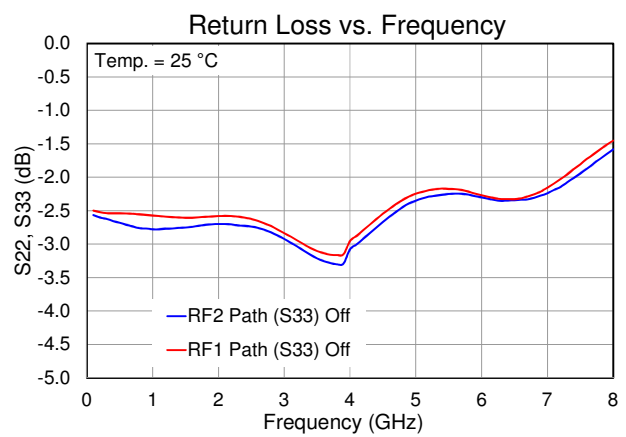
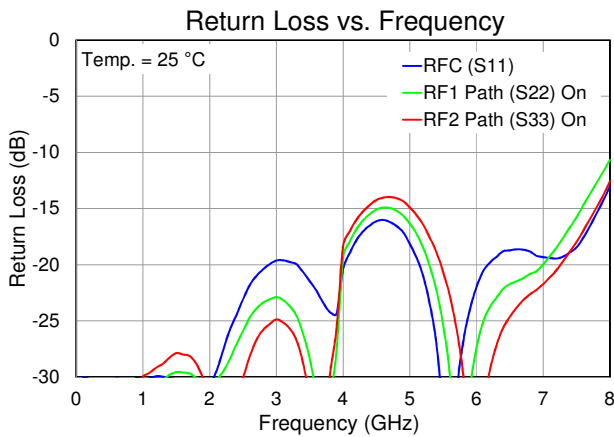
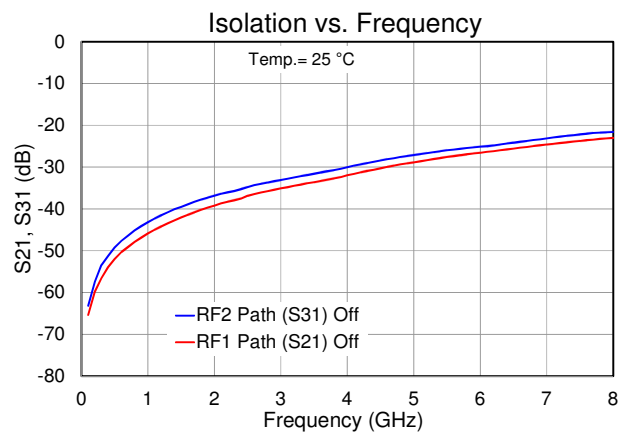
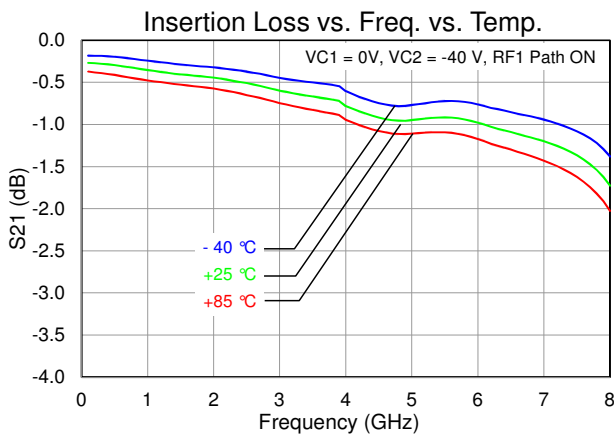
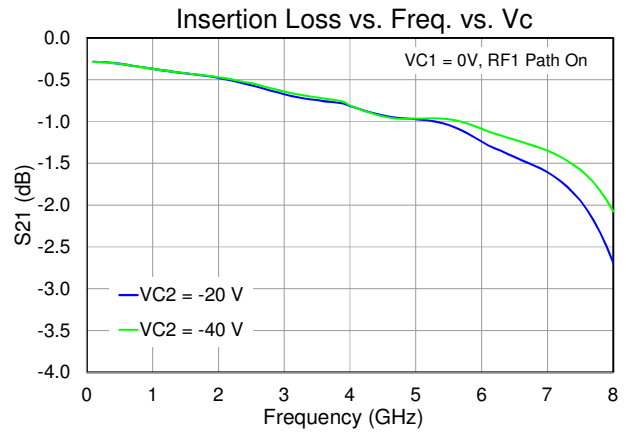
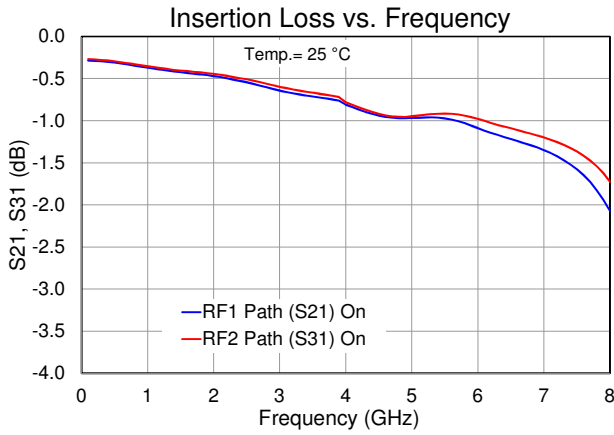

**Typical Performance**

Test conditions unless otherwise noted: CW RF Input, Temp= +25 °C, parts mounted to EVB (page 8)

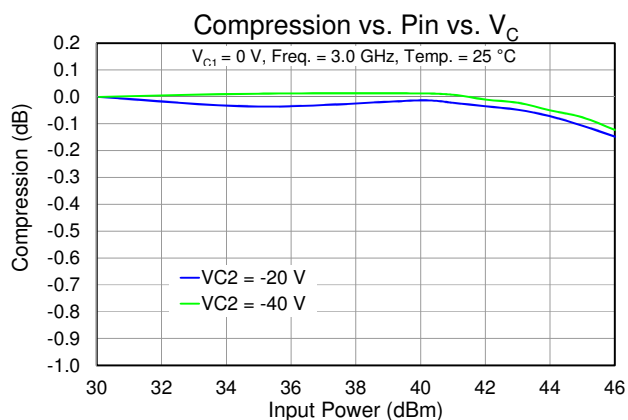
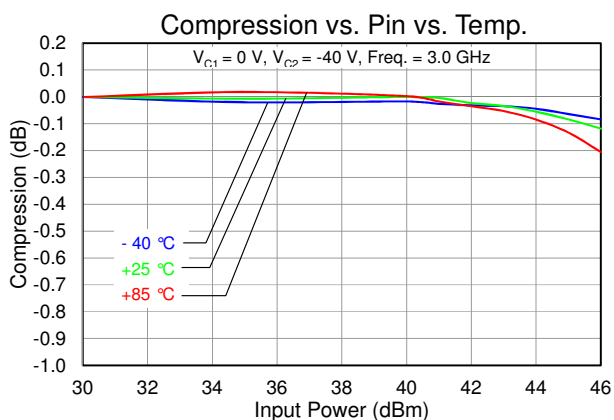
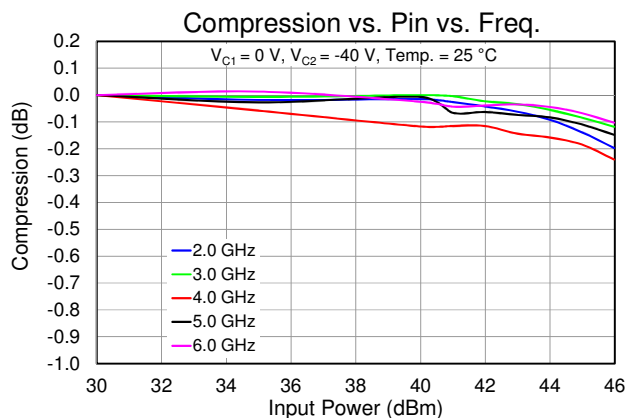
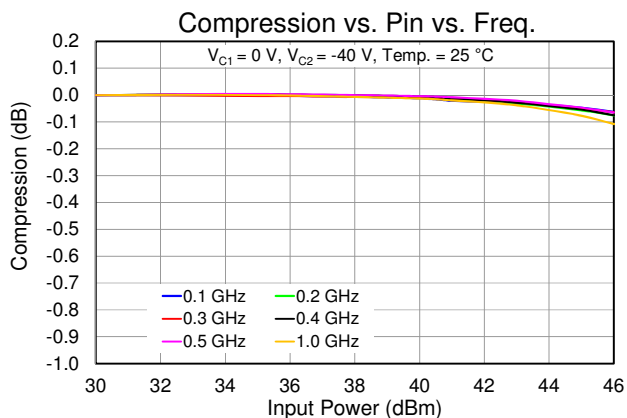

**Application Circuit**

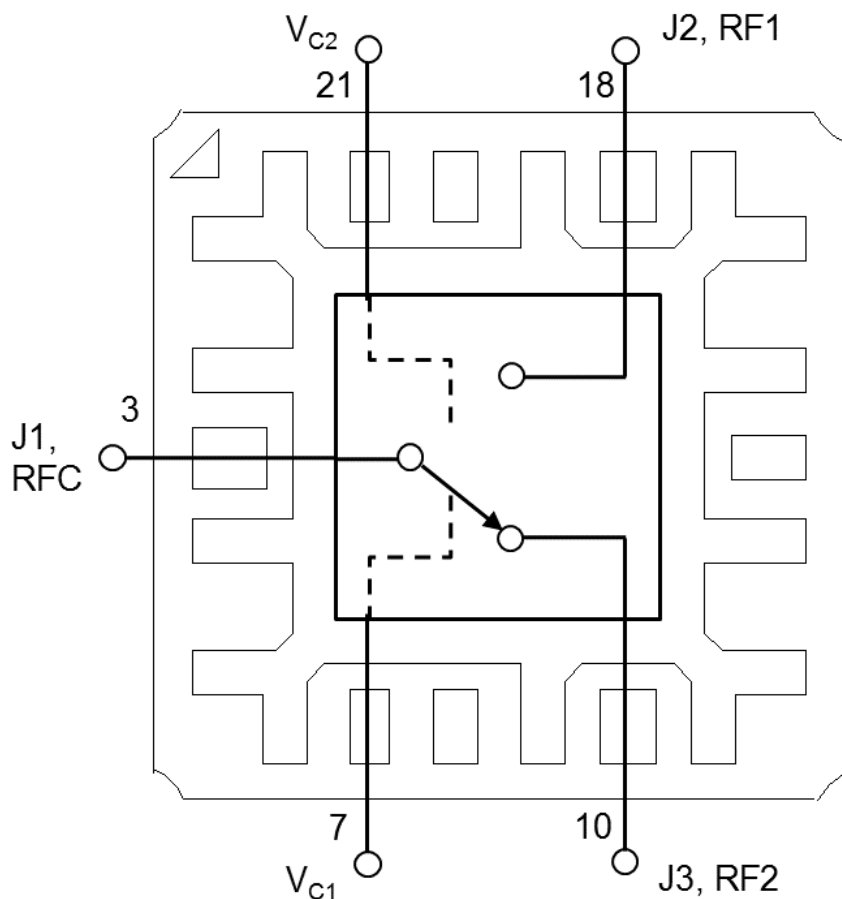

Notes:

DC blocking capacitors are required on all RF ports.

This switch can be configured as a Single Pole, Single Throw (SPST) by terminating one unused RF switched port with a 50 Ohm load.

<b>Function Table</b>			
<b>RF Path</b>	<b>State</b>	<b>V<sub>C1</sub></b>	<b>V<sub>C2</sub></b>
RFC to RF1 (50 Ω load to RF2)	On-State (Insertion Loss)	0 V	-40 V
	Off-State (Isolation)	-40 V	0 V
RFC to RF2 (50 Ω load to RF1)	On-State (Insertion Loss)	-40 V	0 V
	Off-State (Isolation)	0 V	-40 V

## Pin Description

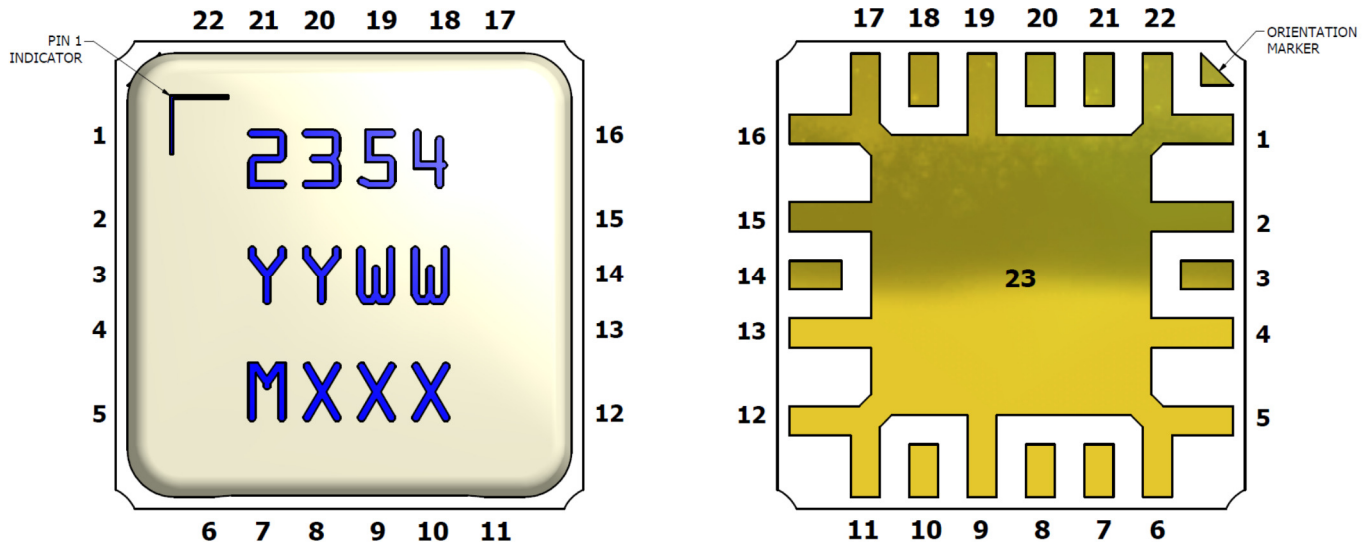

Pin No.	Label	Description
3	RFC	RF common port; matched to 50 Ω; DC coupled
7	VC1	Control voltage 1
10	RF2	RF switched port 2; matched to 50 Ω; DC coupled
18	RF1	RF switched port 1; matched to 50 Ω; DC coupled
21	VC2	Control voltage 2
1-2, 4-6, 8-9, 11-17, 19-20, 22	GND	Connected to ground paddle (23); must be grounded to PCB to improve isolation.
23	GND	Backside paddle. Multiple vias should be employed to minimize inductance and thermal resistance.

### Applications Information

#### Evaluation Board Layout

RF Layer is 0.020" thick Rogers Corp. 6202,  $\epsilon_r = 2.94$ . Metal layers are 0.5 oz. copper. The microstrip line at the connector interface is optimized for the Southwest Microwave end launch connector 292-04A-5.

The pad pattern shown has been developed and tested for optimized assembly at TriQuint Semiconductor. The PCB land pattern has been developed to accommodate lead and package tolerances. Since surface mount processes vary from company to company, careful process development is recommended.

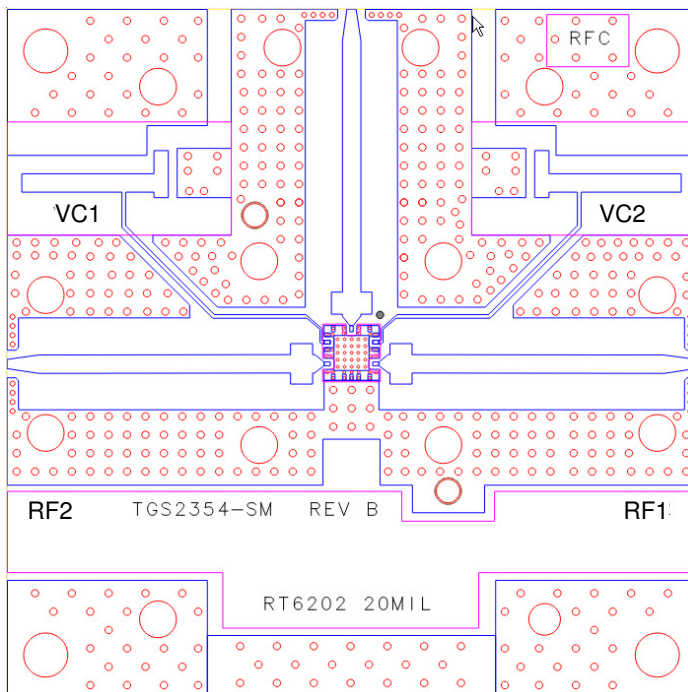

#### EVB Package Mounting Detail

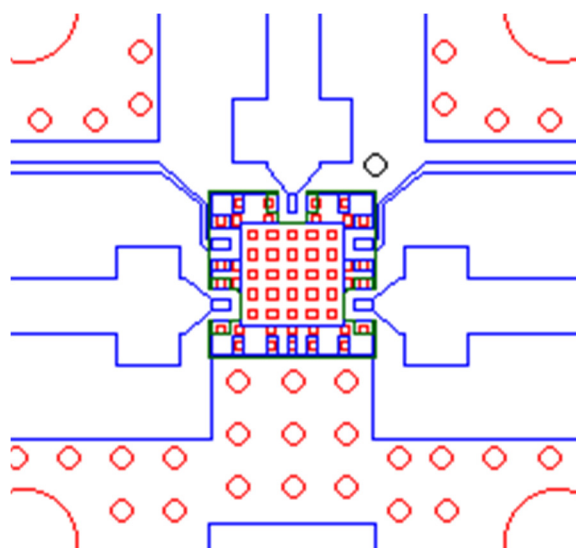

Notes:

1. Flares (as shown) on RF transmission lines are required to achieve best electrical performance.



**Mechanical Information – Package Information and Dimensions**

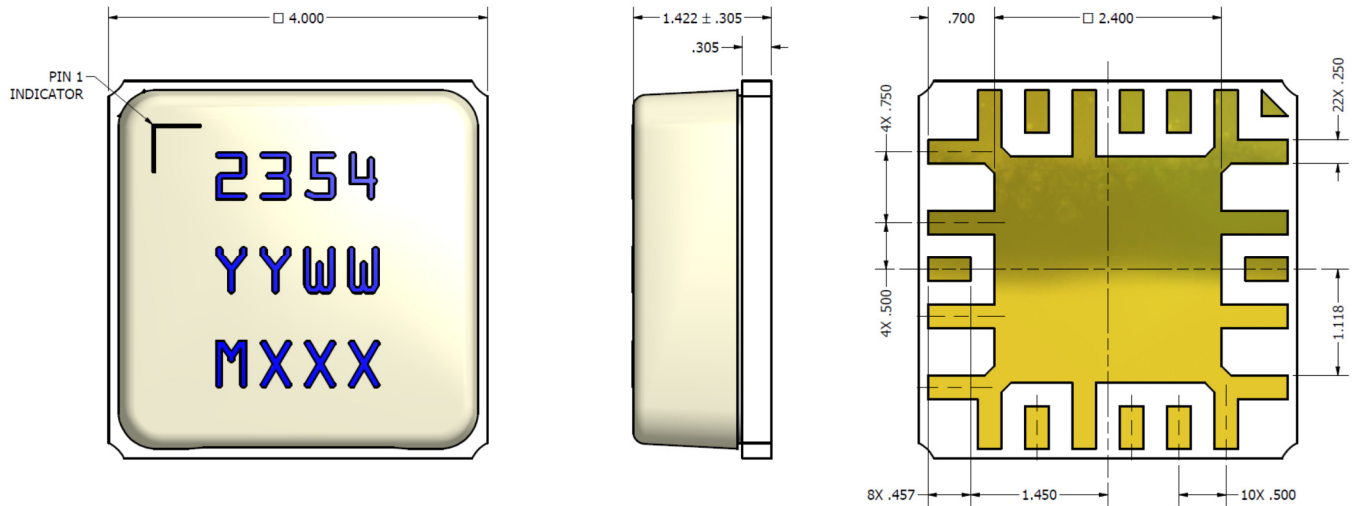

The TGS2354-SM will be marked with the “YYWW” designator and a lot code marked below the part designator. The “YY” represents the last two digits of the year the part was manufactured, the “WW” is the work week, and the “MXXX” is an auto-generated number.

This package is lead-free/RoHS-compliant. The package base is Aluminum Nitride and the plating material on the leads is gold over nickel (Au-Ni). This package is compatible with both lead free and tin-lead soldering processes. The lid is Liquid Crystal Polymer (LCP).

Dimensions are in millimeters.

**Recommended Soldering Temperature Profile**

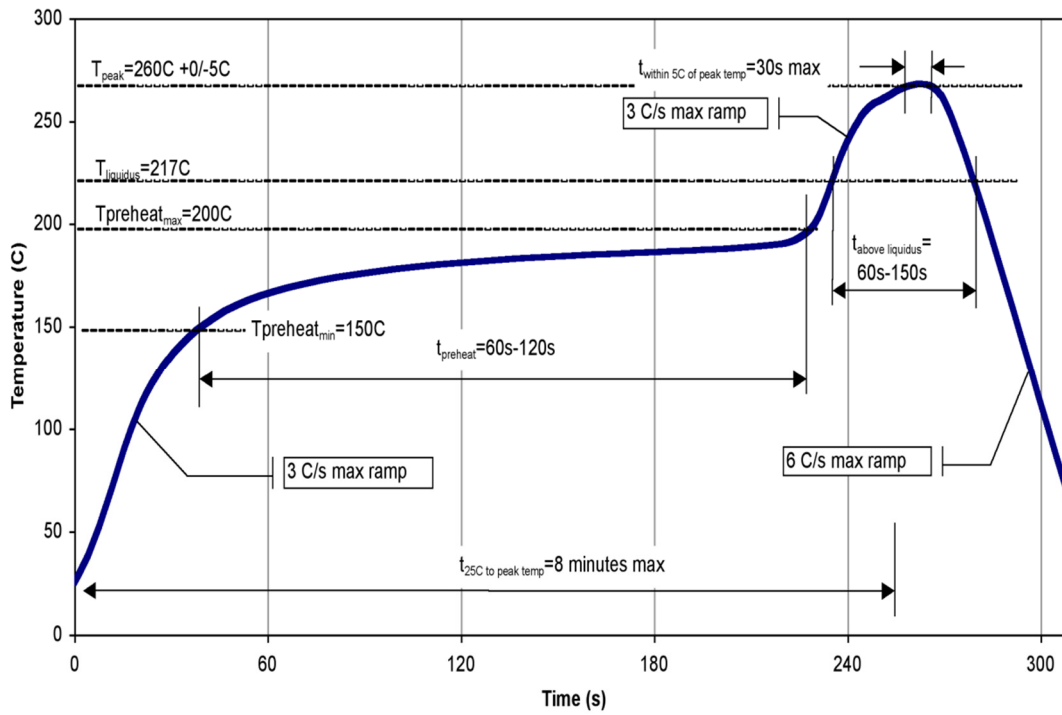

**Product Compliance Information****ESD Sensitivity Ratings**

Caution! ESD-Sensitive Device

ESD Rating: TBD  
Value: TBD  
Test: Human Body Model (HBM)  
Standard: JEDEC Standard JESD22-A114

**ECCN**

US Department of Commerce: EAR99

**Solderability**

Compatible with the latest version of J-STD-020 Lead free solder, 260 °C.

**MSL Rating**

TBD at 260 °C convection reflow  
The part is rated Moisture Sensitivity Level TBD  
JEDEC standard IPC/JEDEC J-STD-020.

**RoHS-Compliance**

This part is compliant with EU 2002/95/EC RoHS directive (Restrictions on the Use of Certain Hazardous Substances in Electrical and Electronic Equipment).

This product also has the following attributes:

- Lead Free
- Halogen Free (Chlorine, Bromine)
- Antimony Free
- TBBP-A (C15H12Br4O2) Free
- PFOS Free
- SVHC Free

## Contact Information

For the latest specifications, additional product information, worldwide sales and distribution locations, and information about TriQuint:

**Web:** [www.triquint.com](http://www.triquint.com)  
**Email:** [info-sales@tqs.com](mailto:info-sales@tqs.com)

**Tel:** +1.972.994.8465  
**Fax:** +1.972.994.8504

For technical questions and application information: **Email:** [info-products@tqs.com](mailto:info-products@tqs.com)

## Important Notice

The information contained herein is believed to be reliable. TriQuint makes no warranties regarding the information contained herein. TriQuint assumes no responsibility or liability whatsoever for any of the information contained herein. TriQuint assumes no responsibility or liability whatsoever for the use of the information contained herein. The information contained herein is provided "AS IS, WHERE IS" and with all faults, and the entire risk associated with such information is entirely with the user. All information contained herein is subject to change without notice. Customers should obtain and verify the latest relevant information before placing orders for TriQuint products. The information contained herein or any use of such information does not grant, explicitly or implicitly, to any party any patent rights, licenses, or any other intellectual property rights, whether with regard to such information itself or anything described by such information.

TriQuint products are not warranted or authorized for use as critical components in medical, life-saving, or life-sustaining applications, or other applications where a failure would reasonably be expected to cause severe personal injury or death.